

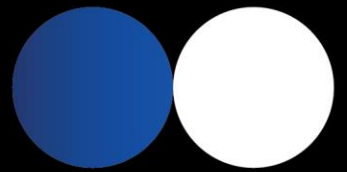

WORLD  
AQUATICS



# COMPETITION REGULATIONS

In force as from 1 January 2025

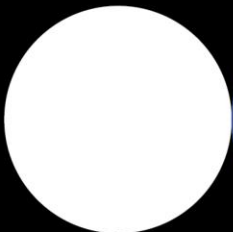
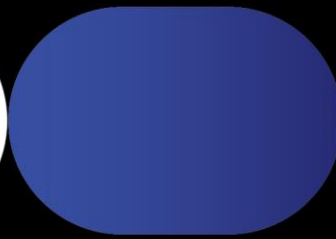

UNITED BY WATER



## TABLE OF CONTENTS OVERVIEW

<b>PART ONE: RULES APPLICABLE TO ALL AQUATIC SPORTS</b> .....		<b>7</b>
1	GENERAL RULES FOR OLYMPIC GAMES, WORLD CHAMPIONSHIPS AND WORLD AQUATICS COMPETITIONS .....	7
2	INTERNATIONAL COMPETITIONS AND WORLD AQUATICS CALENDAR .....	7
3	SPORT NATIONALITY .....	8
4	POLICY ON ELIGIBILITY FOR THE MEN'S AND WOMEN'S COMPETITION CATEGORIES .....	10
5	ELIGIBILITY REQUIREMENTS FOR COMPETITION AND FOR SETTING WORLD AQUATICS RECORDS .....	10
6	REGISTRATIONS AND SPORTS ENTRIES .....	12
7	SWIMWEAR AND WEARABLES .....	18
8	ADVERTISING IDENTIFICATION .....	34
9	MEDICAL RULES .....	40
10	FACILITIES .....	58
11	TECHNICAL OFFICIALS .....	60
12	SCORES, MEDALS AND TROPHIES .....	60
13	APPEALS .....	63
14	MATTERS THAT CAN BE APPEALED .....	65
15	MUSIC REQUIREMENTS .....	65
<b>PART TWO: SWIMMING RULES</b> .....		<b>68</b>
1	MANAGEMENT OF COMPETITIONS .....	68
2	OFFICIALS .....	70
3	SEEDING OF HEATS, SEMI-FINALS AND FINALS .....	73
4	THE START .....	75
5	FREESTYLE .....	75
6	BACKSTROKE .....	75
7	BREASTSTROKE .....	76
8	BUTTERFLY .....	76
9	MEDLEY SWIMMING .....	77
10	THE RACE .....	77
11	TIMING .....	78
12	WORLD RECORDS .....	78
13	AUTOMATIC OFFICIATING PROCEDURE .....	80
14	AGE GROUP RULES – SWIMMING .....	81
15	SWIMWEAR AND WEARABLES .....	81
16	SWIMMING FACILITIES AND EQUIPMENT .....	81
17	MEDICAL AND SAFETY SPECIFIC REQUIREMENTS FOR SWIMMING .....	94
18	APPENDICES .....	95
<b>PART THREE: OPEN WATER SWIMMING RULES</b> .....		<b>108</b>
1	WORLD AQUATICS CHAMPIONSHIPS AND OLYMPIC GAMES .....	108
2	OFFICIALS .....	109
3	DUTIES OF OFFICIALS .....	110
4	THE START .....	113
5	THE RACE .....	114
6	THE FINISH OF THE RACE .....	115
7	SWIMWEAR & TECHNOLOGY .....	116
8	IDENTIFICATION OF COMPETITORS DURING THE RACE .....	116
9	OPEN WATER SWIMMING FACILITIES AND EQUIPMENT .....	116
10	WATER QUALITY GUIDELINES FOR OPEN WATER .....	118



11	OPEN WATER SAFETY REGULATIONS .....	123
12	APPENDICES.....	127
<b>PART FOUR: DIVING RULES .....</b>		<b>136</b>
1	GENERAL.....	136
2	COMPETITIONS.....	137
3	COMPETITION FORMAT.....	138
4	STATEMENT OF DIVES.....	139
5	COMPETITION PROCEDURE .....	140
6	DUTIES OF THE REFEREE AND ASSISTANT REFEREES .....	141
7	DUTIES OF THE SECRETARIAT .....	142
8	JUDGING.....	144
9	REFEREEING AND JUDGING SYNCHRONISED DIVING .....	147
10	SUMMARY OF THE PENALTIES .....	148
11	DIVING AT THE WORLD AQUATICS CHAMPIONSHIPS AND OLYMPIC GAMES.....	150
12	AGE GROUP RULES - DIVING.....	151
13	DIVING FACILITIES AND EQUIPMENT.....	153
14	MEDICAL AND SAFETY SPECIFIC REQUIREMENT FOR DIVING .....	159
15	APPENDICES.....	162
<b>PART FIVE: HIGH DIVING RULES .....</b>		<b>185</b>
1	GENERAL.....	185
2	COMPETITIONS.....	186
3	COMPETITION FORMAT.....	187
4	STATEMENT OF DIVES.....	187
5	COMPETITION PROCEDURE .....	188
6	DUTIES OF THE REFEREE AND ASSISTANT REFEREES .....	188
7	DUTIES OF THE SECRETARIAT .....	190
8	JUDGING.....	191
9	SUMMARY OF THE PENALTIES .....	193
10	AGE GROUP RULES.....	195
11	HIGH DIVING FACILITIES AND EQUIPMENT .....	196
12	DEGREE OF DIFFICULTY - FORMULA AND TABLES.....	208
<b>PART SIX: WATER POLO RULES.....</b>		<b>219</b>
1	THE FIELD OF PLAY & EQUIPMENT.....	219
2	TEAMS & PLAYERS.....	219
3	REFEREES AND TECHNICAL OFFICIALS.....	220
4	DURATION OF THE GAME .....	220
5	TIMEOUTS.....	221
6	START AND RESTART OF PLAY.....	221
7	METHOD OF SCORING.....	221
8	ORDINARY FOULS .....	222
9	EXCLUSION FOULS .....	223
10	PENALTY FOULS.....	225
11	FREE THROWS .....	226
12	GOAL THROWS.....	226
13	CORNER THROWS.....	226
14	NEUTRAL THROWS.....	227
15	PENALTY THROWS .....	227
16	PERSONAL FOULS, YELLOW AND RED CARDS .....	228
17	ACCIDENT, INJURY AND ILLNESS.....	229
18	WATER POLO FACILITIES.....	229
19	BEACH WATER POLO RULES.....	231
20	APPENDICES.....	241



<b>PART SEVEN: ARTISTIC SWIMMING RULES</b> .....	<b>291</b>
1 GENERAL .....	291
2 COMPETITIONS .....	291
3 ELIGIBILITY .....	291
4 SESSIONS .....	291
5 PROGRAMS .....	292
6 ENTRIES .....	293
7 PRELIMINARIES AND FINALS .....	294
8 FIGURE SESSIONS .....	294
9 FIGURE PANELS .....	295
10 JUDGEMENT OF FIGURES .....	295
11 PENALTIES IN FIGURE SESSION .....	295
12 CALCULATION OF THE FIGURE RESULT .....	296
13 ROUTINE SESSIONS .....	296
14 TIME LIMITS FOR ROUTINES .....	298
15 MUSIC ACCOMPANIMENTS .....	298
16 ROUTINE PANELS .....	299
17 JUDGEMENT OF ROUTINES .....	300
18 DEDUCTION, PENALTIES AND OTHER MATTERS IN ROUTINES .....	300
19 CALCULATION OF THE ROUTINE RESULTS .....	313
20 FINAL RESULT .....	313
21 OFFICIALS AND DUTIES .....	314
22 REFEREE .....	315
23 OTHER OFFICIALS .....	315
24 DUTIES OF ORGANIZER .....	315
25 AGE GROUP RULES .....	317
26 SWIMWEAR AND WEARABLES .....	318
27 ARTISTIC SWIMMING FACILITIES AND EQUIPMENT .....	318
28 MEDICAL AND SAFETY SPECIFIC REQUIREMENT FOR ARTISTIC SWIMMING .....	323
29 APPENDICES .....	324
<b>PART EIGHT: MASTERS RULES</b> .....	<b>508</b>
1 GENERAL .....	508
2 MASTERS GENERAL RULES .....	508
3 MASTERS SWIMMING RULES .....	509
4 MASTERS OPEN WATER SWIMMING RULES .....	512
5 MASTERS DIVING RULES .....	513
6 MASTERS WATER POLO RULES .....	515
7 MASTERS ARTISTIC SWIMMING RULES .....	515
8 WORLD AQUATICS MASTERS CHAMPIONSHIPS .....	517



WORLD  
AQUATICS

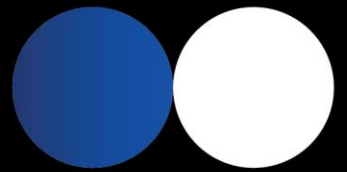

# ALL SPORTS

COMPETITION  
REGULATIONS

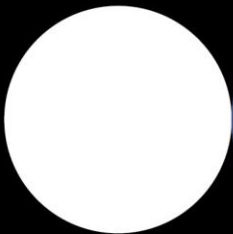
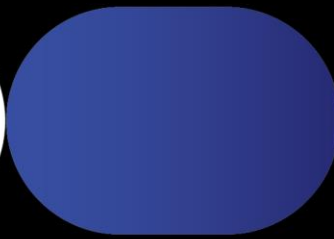



## TABLE OF CONTENTS

### **PART ONE: RULES APPLICABLE TO ALL AQUATIC SPORTS**

<b>PART ONE: RULES APPLICABLE TO ALL AQUATIC SPORTS</b> .....	<b>7</b>
<b>1</b> GENERAL RULES FOR OLYMPIC GAMES, WORLD CHAMPIONSHIPS AND WORLD AQUATICS COMPETITIONS .....	<b>7</b>
<b>2</b> INTERNATIONAL COMPETITIONS AND WORLD AQUATICS CALENDAR .....	<b>7</b>
<b>3</b> SPORT NATIONALITY .....	<b>8</b>
<b>4</b> POLICY ON ELIGIBILITY FOR THE MEN'S AND WOMEN'S COMPETITION CATEGORIES .....	<b>10</b>
<b>5</b> ELIGIBILITY REQUIREMENTS FOR COMPETITION AND FOR SETTING WORLD AQUATICS RECORDS .....	<b>10</b>
<b>6</b> REGISTRATIONS AND SPORTS ENTRIES .....	<b>12</b>
<b>7</b> SWIMWEAR AND WEARABLES .....	<b>18</b>
<b>8</b> ADVERTISING IDENTIFICATION .....	<b>34</b>
<b>9</b> MEDICAL RULES .....	<b>40</b>
<b>10</b> FACILITIES .....	<b>58</b>
<b>11</b> TECHNICAL OFFICIALS .....	<b>60</b>
<b>12</b> SCORES, MEDALS AND TROPHIES .....	<b>60</b>
<b>13</b> PROTESTS AND APPEALS .....	<b>63</b>
<b>14</b> MATTERS THAT CAN BE APPEALED .....	<b>65</b>
<b>15</b> MUSIC REQUIREMENTS .....	<b>65</b>



## PART ONE: RULES APPLICABLE TO ALL AQUATIC SPORTS

### 1 GENERAL RULES FOR OLYMPIC GAMES, WORLD CHAMPIONSHIPS AND WORLD AQUATICS COMPETITIONS

- 1.1** World Aquatics alone shall have the right to organise World Championships and other World Aquatics competitions for Swimming, Diving, High Diving, Water Polo, Artistic Swimming, and Open Water Swimming. The words World and World Aquatics may not be used in connection with any Swimming, Diving, High Diving, Water Polo, Artistic Swimming, or Open Water Swimming event without the consent of World Aquatics.
- 1.2** The World Aquatics Bureau is competent to establish any rules and regulations pertaining to the conduct of the Olympic Games and World Aquatics Championships. It will notably establish the qualification period and system.
- 1.3** The Management Committee for the Olympic Games and World Aquatics Championships shall be the members of the Bureau, who shall act as the Jury of Appeal.
- 1.4** For World Aquatics Championships and Olympic Games Technical Officials selections shall be determined by the appropriate Technical Committee, subject to approval by the Bureau or the Executive.
- 1.5** For each sport in the Olympic Games and World Championships a Commission shall be appointed consisting of the respective Technical Delegate (Bureau Representative) and Chairperson, Vice Chairperson and Secretary of each respective Technical Committee.
- 1.6** Subject to the supervision of the World Aquatics Bureau, the Commissions shall be responsible for:
- a) the conduct of the competition in the respective sport;
  - b) the control of all technical equipment and installations prior to and during the event;
  - c) making rosters for officials; and
  - d) investigating cases of protest as preparation for the Jury of Appeal.
- 1.7** **Political Action**
- No political action shall take place inside or in the immediate vicinity of event's venue(s). The promotion or announcement, by any means, of political messages or any other political actions inside or in the immediate vicinity of the venue(s) is strictly prohibited before, during and after the championships/competition.
- 1.8** **Provocative Action, Racism**
- The Organisers of championships/competitions shall prevent any provocative action being taken by spectators inside or in the immediate vicinity of the event venue(s) (unacceptable levels of verbal provocation from spectators towards competitors or opposing fans, racist behaviour, provocative banners or flags etc.). Should such action arise, the Organisers of championships/competitions shall intervene over the public address system or remove any offensive material, if necessary, with assistance of the police. Stewards shall draw attention of the police to serious acts of misbehaviour, including racist insults; so that offenders may be removed from the venue should the police decide.

### 2 INTERNATIONAL COMPETITIONS AND WORLD AQUATICS CALENDAR

- 2.1** An International Competition shall refer to any competition organised or sanctioned by World Aquatics, any Continental or Regional Organisation or any Member in which other World Aquatics-recognised Federations, clubs or individuals participate.
- 2.2** **International Competitions**
- 2.2.1** **International Competitions are divided into the following tiers:**
- Tier 1.** Major Aquatics Competitions - the Olympic Games, World Aquatics Championships, World Aquatics Swimming Championships (25m);
- Tier 2.** Other World Aquatics Competitions - World Junior and Youth Championships in each sport, World Cups, World Leagues, and other World Aquatics competitions;



**Tier 3.** Continental and Regional Competitions - Continental or Regional Multi-Sport Games, Competitions organised by Continental or Regional Organisations;

**Tier 4.** Member Federation International Competitions - Events organised or sanctioned by a Member Federation in which other World Aquatics Member Federations, clubs or individuals participate:

**Tier 5.** Other competitions of major international importance as defined by World Aquatics.

**2.2.2** All Continental Organisations, Member Federations, and/or members of World Aquatics (including clubs), as well as independent organizers shall seek approval from World Aquatics before announcing dates and place for championships or events which they organize or sanction within their jurisdiction. Approval is, however, not necessary for national competitions in which foreign clubs or individuals not representing their Member Federation participate. The application for approval shall be submitted to World Aquatics at least six months prior to the proposed date of the championships or events.

**2.2.3** Any approval of the International Competition from World Aquatics shall be subject to all conditions and requirements in accordance with the World Aquatics Rules, notably Article 26 of the Constitution. All athletes must comply with World Aquatics eligibility rules.

### **2.3 World Aquatic Calendar**

**2.3.1** World Aquatics shall compile and publish on its website the World Aquatics Calendar in which all International Competitions approved by World Aquatics shall be listed. When a new application for approval of an International Competition is received, World Aquatics will compare the proposed dates of the new International Competition with the World Aquatics calendar to determine if the new dates conflict with a previously approved International Competition. If a conflict is deemed to exist by World Aquatics (or any other issue arises in connection with the proposed International Competition) after considering the aquatic sport, geographic region of the International Competition and/or age group of the Competitors and/or any other matter which World Aquatics may in its discretion take into consideration, World Aquatics will contact the new applicant and advise them that a conflict exists, and request that the dates be changed or competition is postponed to avoid the conflict. Applicants are advised to check the World Aquatics Calendar for potential conflict in dates prior to applying for approval of a new International Competition. It is the policy of World Aquatics that no International Competition of major international importance, with the exception of Masters competitions, should be held within 30 days prior to any Tier 1 Event, without World Aquatics' prior consent.

**2.3.2** Any cancellation or rescheduling of an International Competition that has been approved by World Aquatics and published on the World Aquatic Calendar shall be reported to World Aquatics as soon as practicable prior to the commencement of that competition.

### **2.4 Competition Programme**

**2.4.1** For Tier 3 Continental or Regional Multi-Sport Competitions or Multi-Sport Games, the Competition Programme should include all aquatic sports where possible. Any Tier 3 International Competition should include at a minimum the Competition Programme for the relevant sport at the prior Olympic Games. For Tier 4 and Tier 5 International Competitions, applicants are asked to state in the application for approval the competition programme to be adopted and any deviation from the Competition Programme for the relevant sport at the prior Olympic Games.

**2.4.2** Any application for approval of any International Competition shall indicate the modifications (if any) of the World Aquatics Rules and Regulations applicable to the event.

**2.4.3** Failure to comply with this Section 2 may lead to possible sanctions in accordance with the World Aquatics Constitution.

## **3 SPORT NATIONALITY**

**3.1** Affiliation and Eligibility to represent a World Aquatics Member.

**3.1.1** An Athlete shall be eligible to compete at an International Competition representing a World Aquatics Member if he/she is affiliated to a sole World Aquatics Member and is a citizen of the Country that the Athlete represents by virtue of:

- a) being a citizen of the Country by birth; or
- b) being a citizen of the Country through naturalization and having uninterrupted residence in the Country for at least three years prior to his/her first International Competition.





**3.1.2** In the event an Athlete is a citizen of a country or Sport Country, but does not meet the requisites mentioned under Part One, Article 3.1.1, he/she shall be eligible to compete at International Competitions for a World Aquatics Member by requesting World Aquatics' approval, which will be granted under the following conditions:

- a) the Athlete shall observe a waiting period of three years during which he/she shall not be entitled to represent a World Aquatics Member at International Competition(s); and
- b) the Athlete shall be able to demonstrate by the end of the waiting period at the latest, that he/she has a genuine, close and established link to the country or Sport Country he/she will represent.

### **3.2 Election of a Sport Nationality**

**3.2.1** The Sport Nationality of an Athlete, if aged of more than sixteen years old or if aged of less than sixteen years old, but that no declaration is formulated as per Part One, Article 3.2.2 under, is established at the occasion of the first International Competition that the Athlete is competing on behalf of a World Aquatics Member. If an Athlete is eligible to compete at International Competitions for more than one World Aquatics Member, he/she may choose which World Aquatics Member to represent, being specified that this choice is exercised by competing on behalf of the World Aquatics Member in an International Competition. Thereafter, an Athlete may only represent that World Aquatics Member in International Competitions.

**3.2.2** An Athlete aged of less than sixteen years-old and who is eligible to compete at International Competitions for more than one World Aquatics Member has the possibility to declare to World Aquatics that his/her choice of sport nationality is under consideration. If he/she participates to an International Competition after having made his/her declaration to World Aquatics, his/her sport nationality will not be established by such participation.

**3.2.3** In derogation of Part One, Article 3.2.2 above, a representation at the World Aquatics Championships or Olympic Games determines in all cases a Sport Nationality, no matter the age of the Athlete.

### **3.3 Change of Sport Nationality**

**3.3.1** Any Athlete that intends to change his/her Sport Nationality from one World Aquatics Member to another ("New World Aquatics Member") shall request World Aquatics' approval, which will be granted under the following requisites:

- the Athlete shall observe a waiting period of three years between the last representation for the Member and the first representation for the New World Aquatics Member. The Athlete shall not be entitled to represent any World Aquatics Member at International Competitions during this waiting period;
- the Athlete shall be a citizen by birth or naturalization of the country or Sport Country he/she will represent; and
- the Athlete shall have uninterrupted residence in the country or Sport Country of the New World Aquatics Member for at least three years prior to his/her first International Competitions or shall be able to demonstrate by the end of the waiting period at the latest, that he/she has a genuine, close and established link to the country or Sport Country he/she will represent.

**3.3.2** If an Athlete intends to represent a New World Aquatics Member at any International Competitions, but has previously represented another Member at age categories only (i.e. U16, U18, U20, Youth or Junior), he/she must observe, in derogation of Part One, Article 3.3.1 above, a waiting period of one year between the last representation at age category for the Member and the first representation for the New World Aquatics Member.

### **3.4 Bureau Consultation**

In a case of eligibility or Sport Nationality possessing exceptional and unforeseen circumstances, the Executive Director may consult the Bureau on the application of these rules to an Athlete's particular case. The Executive Director's decision to not consult the Bureau is not appealable.

### **3.5 Possible Breach of the present Rules**

**3.5.1** Any possible breach of the present rules on eligibility and Sport Nationality may be referred to the Aquatics Integrity Unit for investigation and possible proceedings according to the World Aquatics Constitution or other World Aquatics Regulations.



**3.5.2** Without prejudice to any of its other sanctioning powers under the Integrity Code, the Aquatics Integrity Unit may disqualify an Athlete from the International Competitions in question, with all resulting consequences, including forfeiture of all titles, awards, medals, points and prize and appearance money, if such Athlete represented a World Aquatics Member at any International Competitions in violation of the present rules on eligibility and Sport Nationality. In the event the Athlete competed as a member of a relay team or a team, the relay team or the team may similarly be disqualified with all resulting consequences, including forfeiture of all titles, awards, medals, points and prize and appearance money.

**3.6 Enforcement**

The present rules will come into force immediately on 21 February 2023 and will not have retroactive effect. They will apply to all eligibility and change of sport nationality matters filed with World Aquatics as from 21 February 2023. The World Aquatics Office may apply the previously enforced rules on sport nationality during a transitory period until 31 December 2023 at the latest, if the World Aquatics Member and/or Athlete demonstrates that the Athlete had initiated his/her process of eligibility or change of sport nationality before the entry into force of these new rules and that he/she relied upon the old rules on eligibility and sport nationality to organize his/her career. Such evidence may notably consist of correspondence related to an Athlete's change of sport nationality exchanged between the World Aquatics Member and World Aquatics before the entry into force of these new rules.

**4 POLICY ON ELIGIBILITY FOR THE MEN'S AND WOMEN'S COMPETITION CATEGORIES**

World Aquatics is committed to providing safe, fair, inclusive, and non-discriminatory opportunities for all Aquatics Athletes wishing to compete in World Aquatics Competitions. World Aquatics Bureau has thus adopted a Policy on Eligibility for the men's and women's competition categories and fully refers to it. Such Policy and its annexes are a standalone regulation, being noted that some of its provisions are nonetheless included in the present Competitions Regulations regarding eligibility per category (Competitions Regulations Part One, Article 5.2 - 5.6).

**5 ELIGIBILITY REQUIREMENTS FOR COMPETITION AND FOR SETTING WORLD AQUATICS RECORDS**

**5.1 Affiliation**

Any Athlete shall be affiliated to a World Aquatics Member for being eligible to compete in World Aquatics Competitions and to set World Aquatics World Records in World Aquatics Competitions and other Aquatics events recognised by World Aquatics.

**5.2 Eligibility per category**

**5.2.1** Subject to the requirements set forth below, all Athletes are eligible to compete in the men's category or in the women's category in World Aquatics Competitions and to set World Aquatics World Records in World Aquatics competitions and other events recognised by World Aquatics, whatever their legal gender, gender identity, or gender expression. No Athlete is excluded from a World Aquatics Competition or from setting World Aquatics World Records based on their legal gender, gender identity, or gender expression.

**5.2.2** All issues relating to the eligibility of an Athlete under this Regulations to compete in a particular sex category will be determined by World Aquatics following consultation, as necessary, with one or more independent scientific and medical experts appointed by the World Aquatics Executive. It is an important part of this Regulations that the experts can assess whether a given Athlete meets the eligibility criteria set out below. To that end, World Aquatics may ask the Athlete to provide further information and documents and/or to submit to one or more medical examinations. All costs associated with this assessment will be borne by World Aquatics.

**5.3 Certification**

**5.3.1** Athletes must certify their chromosomal sex with their World Aquatics Member in order to be eligible for World Aquatics Competitions. Failure to do so, or provision of a false certification, will render the Athlete ineligible.

**5.3.2** World Aquatics Member must confirm their Athletes' certifications of chromosomal sex when registering their Athletes to compete in World Aquatics Competitions.



**5.3.3** World Aquatics reserves the right to include a chromosomal sex screen in its anti-doping protocol to confirm such certification.

**5.4 Eligibility for the Men's Category**

**5.4.1** All male athletes, including athletes with 46 XY DSD, are eligible to compete in World Aquatics competitions and to set World Aquatics World Records in the men's category, regardless of their legal gender, gender identity, or gender expression.

**5.4.2** Female-to-male transgender athletes (transgender men) are eligible to compete in World Aquatics competitions and to set World Aquatics World Records in the men's category, except that:

**5.4.2.1** For the sports of Water Polo and High Diving, the athlete must provide to World Aquatics an assumption of risk form (in the form set out in Appendix One to this Policy) signed and dated by the athlete or, if the athlete is a minor, by their legal proxy.

*[Comment to Part One, Article 5.4.2.1: It is strongly recommended that the athlete speaks with a qualified medical specialist prior to competition to ensure their physical ability to participate in the event in the men's category and to ensure that they understand the attendant risks.]*

**5.4.2.2** All athletes who are undergoing treatment involving testosterone or other anabolic substances as part of female-to-male gender-affirming hormone treatment are required to obtain a Therapeutic Use Exemption (TUE) for that treatment in accordance with the World Aquatics Doping Control Rules (DCR).

**5.5 Eligibility for the Women's Category**

**5.5.1** All female athletes are eligible to compete in World Aquatics competitions and set World Aquatics World Records in the women's category, regardless of their legal gender, gender identity, or gender expression, under the following conditions:

**5.5.1.1** Athletes who have previously used testosterone as part of female-to-male gender-affirming hormone treatment (with or without a TUE) but are no longer following that treatment are eligible to compete in the women's category in World Aquatics competitions and to set World Aquatics World Records in the women's category in World Aquatics competitions and in other events recognised by World Aquatics if they can establish to World Aquatics's comfortable satisfaction that (a) the testosterone use was for less than a year in total (i.e., from the date of first use to the date of last use) and did not take place during pubertal growth and development, and (b) their testosterone levels in serum (or plasma) are back to pre-treatment normal and any associated anabolic effects have been eliminated.

**5.5.1.2** Female athletes who have used testosterone in violation of the World Anti-Doping Code or World Aquatics DCR (or any other applicable anti-doping rules) may return to competition after they have served their period of ineligibility.

**5.5.2** Male-to-female transgender athletes (transgender women) and athletes with 46 XY DSD whose legal gender and/or gender identity is female are eligible to compete in the women's category in World Aquatics competitions and to set World Aquatics World Records in the women's category in World Aquatics competitions and in other events recognised by World Aquatics if they can establish to World Aquatics's comfortable satisfaction that they have not experienced any part of male puberty beyond Tanner Stage 2 or before age 12, whichever is later. Specifically, the athlete must produce evidence establishing that:

**5.5.2.1** They have complete androgen insensitivity and therefore could not experience male puberty; or

**5.5.2.2** They are androgen sensitive but had male puberty suppressed beginning at Tanner Stage 2 or before age 12, whichever is later, and they have since continuously maintained their testosterone levels in serum (or plasma) below 2.5 nmol/L.

**5.5.2.3** An unintentional deviation from the below 2.5 nmol/L requirement may result in retrospective disqualification of results and/or a prospective period of ineligibility.

**5.5.2.4** An intentional deviation from the below 2.5 nmol/L requirement may result in retrospective disqualification of results and a prospective period of ineligibility equal or commensurate in length to periods imposed under the World Aquatics DCR for intentional anti-doping rule violations involving anabolic steroids.

*[Comment to Part One, Article 5.5.2.4: For purposes of the Policy, all measurements of serum testosterone must be conducted by means of liquid chromatography coupled with mass spectrometry.]*

**5.6 Process for Application**

The process for applications for eligibility is set forth in the Operational Requirements (see Appendix Two to this Policy).

**5.7 Competition Officials Eligibility**

Competition Officials must be on current World Aquatics Lists approved by the respective Technical Committee for the aquatics sport in order to officiate at Olympic Games and World Championships. Nominated officials must be members of the nominating Federation and certified by the Member Federation on the nomination form.

**6 REGISTRATIONS AND SPORTS ENTRIES****6.1 General - Registration and Sport Entries****6.1.1 For World Aquatics Events**

**6.1.1.1** Each National Federation concerned must confirm its desire to take part in the World Championships by completing the preliminary entries in the World Aquatics General Management System ('GMS') by the defined "preliminary entries" deadline.

All entries must be fully submitted in the GMS before the date determined by World Aquatics as published in the respective summons for the Championships. World Aquatics shall verify all registrations according to appropriate eligibility rules for participation and competitor entry for each competition.

**6.1.1.2** Each National Federation must confirm the final number of male and female competitors that will attend the Championships by completing their nomination in the GMS by the defined "nomination deadline".

**6.1.2 For Olympic Games**

Sport entries shall be made on official forms signed by the Secretary of the respective National Olympic Committee and delivered to the Organising Committee of the Country holding the Games, on or before the date determined by the International Olympic Committee. The World Aquatics Office shall claim these entries at least seven (7) days before the start of the first competition.

**6.1.3 Substitution**

Any entered competitor may be substituted by another entered competitor at the Team Leaders' Meeting. It is mandatory for one representative of each Federation to take part in the Team Leaders' Meeting. Failing to do so will result in a fine of one-hundred (100) Swiss Francs.

**6.1.4 Withdrawal**

In all competitions except water polo, a competitor or team not wishing to take part in a semi-final or final in which qualification was earned shall withdraw within thirty (30) minutes following the preliminaries or the semi-finals of the event in which the qualification took place. The Member Federation of any competitor who withdraws from the heats/preliminary rounds after the Team Leaders' Meeting or from a semi-final or final more than thirty (30) minutes after the preliminaries or semi-finals of the event in which qualification was earned, shall pay without excuse to World Aquatics the sum of one-hundred (100) Swiss francs; in case of a relay, duet or team, the sum shall be two-hundred (200) Swiss francs.

If a team withdraws from a World Aquatics Water Polo event any time after the draw has been concluded, and without the approval of the Management Committee, then that team will be sanctioned by the Bureau with an economic sanction of eight-thousand (8,000) Swiss Francs, from which six-thousand (6,000) Swiss Francs goes to the Organiser, and suspension from all competitions for a minimum period of three months up to a maximum period of two years.

If a competitor in the World Aquatics Open Water Swimming 3km Knockout Sprint event not wishing to take part in a semi-final or final in which qualification was earned shall withdraw within five (5) minutes following the preliminaries or semi-final of the event in which the qualification took place.

**6.1.5 Disqualification**



In Swimming, Open Water Swimming, Diving, and Artistic Swimming, where a competitor who competed in the semi-finals or final is disqualified for any reason, including medical control, the position he/she would have held shall be awarded to the competitor who finished next and all the lower placing competitors in the semi-finals or final shall be advanced one place. If the disqualification occurs after the presentation of awards, the awards shall be returned and given to the appropriate competitors applying the foregoing provisions.

#### **6.1.6 Specific cases**

**6.1.6.1** Competitors entered for Diving, High Diving, Water Polo, and Artistic Swimming cannot swim relay events, and those entered for Swimming, Open Water Swimming, Diving, High Diving and Artistic Swimming cannot be used as Water Polo reserves, with the provision that one and the same swimmer could compete in Water Polo as well as other Swimming competitions, if officially entered for such competitions.

**6.1.6.2** If an error by an official follows a fault by a competitor, the fault by the competitor may be expunged. If an official's call on deck leads to a review of an athlete's potential infraction, and it is deemed that the athlete made no error, the athlete will be cleared of the inquiry. Additionally, if an error by a competitor follows a fault by an official, the fault of the competitor shall be expunged.

#### **6.2 Swimming - Registration and Sport Entries**

##### **6.2.1 Standard Entry Times A and B**

For each individual event at the World Aquatics Championships, the World Aquatics Bureau will establish Standard Entry Times in two levels: "A" and "B", of which "B" shall be easier to achieve.

- Standard Entry Times can only be achieved in competitions approved for that purpose by World Aquatics.
- For each individual event at the World Aquatics Championships, each National Federation may enter a maximum of two (2) competitors. To enter two (2) swimmers in the same event, both of them must have achieved the "A" Standard Entry Time.
- To enter one (1) swimmer in an event, the competitor must have achieved at least the "B" Standard Entry Time.
- Swimmers having achieved only one (1) "A" or one "B" entry time are entitled to enter one (1) additional event. The additional individual event must be in an event where no other swimmer from the National Federation has been entered.

##### **6.2.1.1 Sport Entry with no Standard Times**

At the World Aquatics Championships, National Federations may enter swimmers who have not achieved either Standard Entry Time as follows:

- With no swimmers who have achieved the "A" or "B" Standard Entry Time: National Federations may enter up to four (4) swimmers, two (2) men and two (2) women.
- With one (1) or two (2) swimmers who has achieved the "A" or "B" Standard Entry Time: National Federations may enter up to a maximum of four (4) swimmers (two (2) men and two (2) women), and with three (3) swimmers who have achieved the "A" or "B" Standard Entry Time, one (1) additional swimmer provided that both genders are represented.
- The swimmers who have not achieved a Standard Entry Time will only be permitted to enter up to two (2) individual events each.
- An individual entry for a swimmer without an "A" or "B" Standard Entry Time must be in an event where no other swimmer from the National Federation has been entered.

##### **6.2.2 Entry of Relays**

At the World Aquatics Championships, each National Federation may enter only one (1) team in each relay. The members of such entered team(s) shall comprise:

- Any swimmers entered in individual events even if they have not achieved a "A" or "B" Standard Entry Time for the corresponding stroke and distance of the relay in which they are entered;

Additional swimmers as relay-only competitors, provided that they have achieved the "B" Standard Entry Time for the corresponding stroke and distance of the relay in which they are entered. Any additional swimmers must be within the maximum quota of swimmers for the event.

##### **The following formula shall apply:**

- One (1) Relay: two (2) additional swimmers



- Two (2) Relays: four (4) additional swimmers
- Three (3) Relays: six (6) additional swimmers
- Four (4) Relays: eight (8) additional swimmers
- Five (5) Relays: ten (10) additional swimmers
- Six (6) or more Relays: twelve (12) additional swimmers

**6.2.2.1** The names of swimmers actually swimming on a relay must be submitted at least one hour before the start of the session in which the event is to take place, in the order in which they are to swim. The names of swimmers in medley relay events must be listed for their respective strokes.

### **6.2.3 Swimming Qualifying Times**

- World Aquatics will maintain a listing of Swimming Qualifying Times achieved during the qualification period, called the World Aquatics Rankings.
- National Federations will enter swimmers and relay teams using the World Aquatics Rankings as the entry time for seeding purposes. Where no valid time information is recorded in the World Aquatics Rankings, the swimmer or relay team will be entered with no time.
- Only valid times included in the World Aquatics Rankings at the date of the deadline for entries and achieved within the qualification period can be accepted as entry times.
- The National Federation must fully submit all sports entries via the GMS in accordance with the established entry deadlines in order to be accepted for the competition.
- The heats, semi-finals and finals shall be arranged in accordance with Part II, under the supervision of the Technical Swimming Committee.

### **6.2.4 Maximum number of swimmers**

Each Member Federation may enter a maximum number of twenty-six (26) men and twenty-six (26) women swimmers.

### **6.2.5 Publication of Sport Entry List**

The entry list shall be published at least four (4) days before the first day of competition.

### **6.2.6 Qualification system**

The World Aquatics Bureau is competent to develop and define the Swimming qualification principles/system related to World Aquatics Championships and World Aquatics Swimming Championships (25m).

For the Olympic Games, it will be done in collaboration with the International Olympic Committee (IOC).

## **6.3 Open Water Swimming - Registration and Sport Entries**

### **6.3.1 Sports Entries for the Olympic Games and the World Aquatics Championships**

Each Member Federation may enter a maximum of two (2) male and two (2) female competitors per individual event.

For team events in the World Championships, the Member Federation can enter only one (1) team per event comprised of two male and two female Competitors. Athletes may only swim in one team event. Withdrawals can be made up to and including the Teams Leaders' Meeting.

### **6.3.2 Sport Entry for World Aquatics Junior Open Water Swimming Championships**

Each Member Federation may enter a maximum of two (2) male and two (2) female competitors per individual event.

For team events in the World Aquatics Junior Open Water Championships, the Member Federation can enter only one (1) team per event comprised of two male and two female Competitors. Athletes may only swim in one team event.

Teams events in 14-15-16; & U/19. Swimmers may only swim one team event.

### **6.3.3 Qualification system**

The World Aquatics Bureau is competent to develop and define the qualification principles/system related to the World Aquatics Championships.

For the Olympic Games, qualifying criteria will be determined in collaboration with the IOC.

**6.4 Diving - Registration and Sport Entries****6.4.1 Sports Entry for the Olympic Games and World Aquatics Championships**

Each Member may enter a maximum of two (2) competitors, for each individual event and one (1) team of two (2) competitors for each synchronised diving event.

**6.4.2 Substitution at the Olympic Games**

Following the Team Leaders' meeting at the Olympic Games, a diver may be substituted by another diver from the same Federation in accordance with Diving Rules 4.7 and 4.7.1, provided that the replacement does not impact the number of allocated quota spots for Diving. If it does, the replacement will not be permitted except in exceptional circumstances approved by the Bureau and then only if payment of CHF10,000 accompanies the substitution form.

**6.4.3 Qualification system**

The World Aquatics Bureau is competent to develop and define the Diving qualification principles/system related to the World Aquatics Championships.

For the Olympic Games, it will be done in collaboration with the IOC.

**6.5 Artistic Swimming - Registration and Sport Entries****6.5.1 Sports Entries for the Olympic Games and the World Aquatics Championships**

For Olympic Games, Team routines shall consist of eight (8) athletes. The total number of athletes entered by each Member Federation (unless otherwise specified) may not exceed nine (9) athletes, one as reserve. The total number of athletes may include a maximum of two (2) male athletes.

For World Aquatics Championships and World Aquatics competitions, team routines shall consist of eight (8) competitors and ten (10) for Free Combination.

For Artistic Swimming World Aquatics competitions the total number of competitors entered by each Member Federation (unless otherwise specified) may not exceed fourteen (14) competitors including maximum two male competitors only if the Federation enters Mixed Duets/Teams.

**6.5.2 Qualification system**

The World Aquatics Bureau is competent to develop and define the qualification principles/system related to World Aquatics Championships.

For the Olympic Games, it will be done in collaboration with the IOC.

**6.6 Water Polo****6.6.1 Sports Entries For Water Polo**, an entry of a maximum of fourteen (14) players per game may be accepted.

For the World Aquatics Championships fourteen (14) players and one (1) reserved players can be registered, but fourteen (14) players are in the actual playing squad. For the other World Aquatics Water Polo Events, the number of registered players may vary, but there are maximum of fourteen (14) players on a game.

For the Olympic Games, an entry of a maximum of thirteen (13) players may be accepted.

**6.6.2 Number of Teams for World Aquatics Championships****6.6.2.1 Men****6.6.2.1.1 The competition shall be between a maximum of sixteen (16) teams selected in the following manner:****6.6.2.1.2** The three (3) highest-ranking teams from the preceding World Aquatics Championships, or Olympic Games, three (3) highest-ranking teams from the preceding year's World Cup (formerly World League), one (1) team from the host country and nine (9) teams from the five (5) continents to be selected through continental qualification tournaments or continental championships. The nine (9) teams from the continents shall be selected according to the following formula: Europe - 3; Americas - 2; Asia - 2; Africa - 1; and Oceania - 1.**6.6.2.1.3** If any one of the teams qualified from the preceding year's World Cup are in the first three (3) from the preceding World Aquatics Championships or Olympic Games, the next ranked team from that World Aquatics Championships or Olympic Games qualifies.



**6.6.2.1.4** The highest qualifying team(s) from the continental qualification tournament or continental championships shall be entitled to represent that continent; if any team does not accept, then the next highest ranking team willing to accept and participate in the World Aquatics Championships shall qualify.

**6.6.2.1.5** If the host country is already included in the three (3) highest-ranking teams from the preceding World Aquatics Championships, World Cup or Olympic Games, then that entry position shall be filled by the next highest-placed team from that World Aquatics Championships Olympic Games.

**6.6.2.1.6** If another of the three (3) highest-ranking teams from the preceding World Aquatics Championships or Olympic Games or one (1) of the two (2) highest-ranking teams from the preceding year's World Cup does not enter, then that position shall be filled from the next highest placed team from that World Aquatics Championships or Olympic Games.

**6.6.2.1.7** If no team enters from a continent or if there is an unfilled vacancy from among the teams qualifying from the preceding World Aquatics Championships, Olympic Games or preceding year's World Cup, then each vacancy for that World Championship shall be filled by the next highest placed team(s) from the actual World Ranking.

#### **6.6.2.2 Women**

**6.6.2.2.1 The competition shall be between a maximum of sixteen (16) teams selected in the following manner:**

**6.6.2.2.2** The three (3) highest-ranking teams from the preceding World Aquatics Championships or Olympic Games, three (3) highest-ranking teams from the preceding year's World Cup (formerly World League), one (1) team from the host country and nine (9) teams from the five (5) continents to be selected through continental qualification tournaments or continental championships. The nine (9) teams from the continents shall be selected according to the following formula: Europe - 3; Americas - 2; Asia - 2; Africa - 1; and Oceania - 1.

**6.6.2.2.3** If any one of the teams qualified from the preceding year's World Cup is in the first three (3) from the preceding World Aquatics Championships, World Cup or Olympic Games, the next ranked team from that World Championships or Olympic Games qualifies.

**6.6.2.2.4** The highest qualifying team(s) from the continental qualification tournament or continental championships shall be entitled to represent that continent; if any team does not accept, then the next highest ranking team willing to accept and participate in the World Championships shall qualify.

**6.6.2.2.5** If the host country is already included in the three (3) highest-ranking teams from the preceding World Aquatics Championships, World Cup or Olympic Games, then that entry position shall be filled by the next highest-placed team from that World Aquatics Championships or Olympic Games.

**6.6.2.2.6** If another of the three (3) highest-ranking teams from the preceding World Aquatics Championships or Olympic Games or one (1) of the two (2) highest-ranking teams from the preceding year's World Cup does not enter, then that position shall be filled from the next highest placed team from that World Championships or Olympic Games.

**6.6.2.2.7** If no team enters from a continent or if there is an unfilled vacancy from among the teams qualifying from the preceding World Aquatics Championships or Olympic Games or preceding year's World Cup, then each vacancy for that World Championship shall be filled by the next highest placed team(s) from the actual World Ranking.

#### **6.6.3 Number of Teams for Olympic Games**

##### **6.6.3.1 Men**

The competition shall be between twelve (12) teams.

##### **6.6.3.2 Women**

The competition shall be for ten (10) teams.

##### **6.6.3.3 Qualification system**

In collaboration with IOC, the World Aquatics Bureau is competent to develop and define the qualification principles/system related to the Olympic Games.

#### **6.6.4 Number of Teams for World Aquatics Water Polo Championships U20**

##### **6.6.4.1 Men**

**6.6.4.1.1** The competition may be between twenty (20) teams.





- 6.6.4.1.2** For the twenty (20) team competition, the competition may occur at two (2) sites in one country. The host country will be responsible for the transportation of the teams from one site to another as required. This transportation will be at the expense of the host country.
- 6.6.4.1.3** In the case of a maximum twenty (20) team competition, the teams shall include the highest-ranking team from the preceding U20 World Aquatics Championships with the remaining teams selected through continental qualification tournaments or continental qualification tournaments or continental championships according to the following formula: Europe - 7; Americas - 5; Asia - 4; Africa - 2; and Oceania - 2. The host to be included in the Continental quota. The highest ranking team from the preceding U20 World Aquatics Championships will be considered to be a representative of that continent for the purpose of the formula.
- 6.6.4.1.4** The highest qualifying team(s) from the continental qualification tournament or continental championships shall be entitled to represent that continent; if any team does not accept, then the next highest-ranking team willing to accept and participate in the World Junior Championships shall qualify.
- 6.6.4.2 Women**
- 6.6.4.2.1** The competition may be between twenty (20) teams.
- 6.6.4.2.2** For the twenty (20) team competition, the competition may occur at two (2) sites in one country. The host country will be responsible for the transportation of the teams from one site to another as required. This transportation will be at the expense of the host country.
- 6.6.4.2.3** In the case of a maximum twenty (20) team competition, the teams shall include the highest-ranking team from the preceding U20 World Aquatics Championships with the remaining teams selected through continental qualification tournaments or continental qualification tournaments or continental championships according to the following formula: Europe - 7; Americas - 5; Asia - 4; Africa - 2; and Oceania - 2. The host to be included in the Continental quota. The highest-ranking team from the preceding U20 World Aquatics Championships will be considered to be a representative of that continent for the purpose of the formula.
- 6.6.4.2.4** The highest qualifying team(s) from the continental qualification tournament or continental championships shall be entitled to represent that continent; if any team does not accept, then the next highest-ranking team willing to accept and participate in the World Junior Championships shall qualify.
- 6.6.4.2.5** For a maximum of twenty (20) team competition, if there is an unfilled vacancy from a continent, then that vacancy shall be filled by the next highest placed team(s) from the actual World Ranking.
- 6.6.5 Number of Teams for World Aquatics Water Polo Championships U18**
- 6.6.5.1 Men**
- 6.6.5.1.1** The competition may be between twenty (20) teams.
- 6.6.5.1.2** For a twenty (20) team competition, the competition may occur at two (2) sites in one country. The host country will be responsible for the transportation of the teams from one site to another as required. This transportation will be at the expense of the host country.
- 6.6.5.1.3** In the case of twenty (20) team competition, the teams shall include the highest-ranking team from the preceding World Youth Championships with the remaining teams selected through continental qualification tournaments or continental championships according to the following formula: Europe - 7; Americas - 5; Asia - 4; Africa 2; and Oceania - 2. The host to be included in the Continental quota. The highest-ranking team from the preceding World Youth 3 Championships will be considered to be a representative of that continent for the purpose of the formula.
- 6.6.5.1.4** The highest qualifying team(s) from the continental qualification tournament or continental championships shall be entitled to represent that continent; if any team does not accept, then the next highest ranking team willing to accept and participate in the World Youth Championships shall qualify.
- 6.6.5.1.5** For a maximum of twenty (20) team competition, if there is an unfilled vacancy from a continent, then that vacancy shall be filled by the next highest-placed team(s) from the actual World Ranking.
- 6.6.5.2 Women**
- 6.6.5.2.1** The competition may be between twenty (20) teams.



**6.6.5.2.2** In the case of a maximum of twenty (20) team competition, the teams shall include the highest-ranking team from the preceding U20 World Aquatics Championships with the remaining teams selected through continental qualification tournaments or continental qualification tournaments or continental championships according to the following formula: Europe - 7; Americas - 5; Asia - 4; Africa - 2; and Oceania - 2. The host is to be included in the Continental quota. The highest-ranking team from the preceding U20 World Aquatics Championships will be considered to be a representative of that continent for the purpose of the formula.

**6.6.5.2.3** The highest qualifying team(s) from the continental qualification tournament or continental championships shall be entitled to represent that continent; if any team does not accept, then the next highest ranking team from the continental qualification tournament or continental championships shall be entitled to represent that continent.

**6.6.5.2.4** If there is an unfilled vacancy from a continent, then that vacancy shall be filled by the next highest placed team(s) from the actual World Ranking.

#### **6.6.6 Number of Teams for World Aquatics Water Polo Championships U16**

The competition may be between a maximum of thirty-two (32) men teams and a maximum of twenty four (24) women teams. The list of teams is upon Continental invitations. The teams shall include the highest ranking team from the preceding World U16 Championships with remaining teams selected through continental qualification tournaments or continental championships and finally on Continental recommendation.

#### **6.6.7 Olympic Games Qualification Tournament - Men**

The competition shall be between a maximum of twelve (12) teams selected through continental qualification tournaments or continental championships in the following manner:

The twelve (12) teams from the continents shall be selected according to the following formula: Europe - 5; Americas - 3; Asia - 2; Africa - 1; and Oceania - 1. The Host Country will be considered to be a representative from that Continent.

The highest qualifying team(s) from the continental qualification tournament or continental championship (except the team who has already qualified) shall be entitled to represent that continent; if any teams do not accept, then the next highest ranking team willing to accept and participate in the Olympic Games Qualification Tournament shall qualify.

If there is an unfilled vacancy from a continent, then that vacancy shall be filled by the next highest placed team(s) from the actual World Ranking.

#### **6.6.8 Qualification for Olympic Games - Women**

The competition shall be for a maximum of ten (10) teams selected in the following manner:

The first team from the preceding year's World Cup.

The first team from the preceding World Championships. If this team has already qualified from the preceding year's World Cup, the next ranked team from the World Championships qualifies.

The Host Country will automatically qualify.

Automatically, one (1) team from the Continental Championships of the five (5) continents. If it is qualified at the preceding year's World Cup, or at the preceding FINA World Championships, then the next ranked team from the continental championships will qualify.

The other two (2) teams qualify from the Olympic Games Qualification Tournament - Women.

If for any reason, qualified teams do not wish to participate in the Olympic Games, the next ranking team(s) will then be taken in order from their placing at the Olympic Games Qualification Tournament - Women.

AQUA has authority to amend the rule and list in chronological order to reflect the qualification of teams in accordance with the timing of AQUA Events.

## **7 SWIMWEAR AND WEARABLES**

### **7.1 Swimwear for all Aquatics sports**



Swimwear to be used in World Aquatics Competitions, World Aquatics Sanctioned Competitions, qualifying events for World Aquatics Competitions or Olympic Games shall meet the requirements provided in this section. The Rules in this Section are also complemented by Swimwear Rules per Aquatics sports (Sections II to IX under) and Technical & Approval Implementing Rules for Swimwear (Part One, Article 7.5).

The Athlete's safety and health are to be taken into consideration in regard to Swimwear. All matters regarding Swimwear shall be aligned with the fair play and a sound development of the Sports.

Athletes' Swimwear shall be non-transparent, in good moral taste and suitable for the individual Aquatics sports and not to carry any symbol which may be considered offensive.

These rules do not regulate directly issues on markings (team, emblems, manufacturer markings, sponsor markings), which are described under Part One, Article 8. However, they address markings (including also technical markings) in connection with their potential relevance from the point of view of the approval criteria (notably thickness and permeability).

## **7.2 Swimwear Approval Procedure for Swimming and Open Water**

**7.2.1** Swimwear to be used in World Aquatics Competitions, World Aquatics Sanctioned Competitions, qualifying events for World Aquatics Competitions or Olympic Games in Swimming and Open Water shall be approved by World Aquatics.

**7.2.2** The Technical & Approval Implementing Rules for Swimwear (Part One, Article 7.5) define the requirements linked to design, composition, colour, material, flexibility, construction and others related to Swimsuit, Wetsuit, Caps and Goggles.

**7.2.3** The Approval Procedure of Swimwear is conducted by the World Aquatics Office and supervised by an independent swimwear expert.

### **7.2.4 The Independent Swimwear Expert – Appointment**

The Independent Swimwear Expert is appointed and removed by the World Aquatics Bureau. He/she shall be independent from the manufacturers. In particular, he/she shall not have any relationship with a Swimwear manufacturer (whether of contractual nature or as a shareholder direct or indirect) nor have had such during the five (5) preceding years.

### **7.2.5 The Independent Swimwear Expert – Role**

The Independent Swimwear Expert shall develop and propose uniform principles and directions for the approval of new advancements in the field of competition equipment.

The Independent Swimwear Expert will have the following responsibilities and authority:

- to check if the swimwear complies with the technical requirements of these Regulations, and the Technical & Approval Implementing Rules for Swimwear, in cooperation with the testing laboratory;
- to approve or reject the application submitted by the manufacturers;
- to provide expertise to the World Aquatics Office; and
- any other matter related to Swimwear.

**7.2.6** Implementing rules regarding the Approval Procedure, notably as such as the submission, the examination of a submission, the notification of the results of a submission, or re-submission, are defined under the Technical & Approval Implementing Rules for Swimwear.

## **7.3 Testing**

Testing standards applicable to the examination, in particular thickness and permeability measurements, are determined under the Technical & Approval Implementing Rules for Swimwear (Part One, Article 7.5).

## **7.4 List of Approved Swimwear**

The latest List of Approved Swimwear is updated after each approval or removal of a Product. The List references the Swimwear that may be used by Athletes at World Aquatics Competitions, World Aquatics Sanctioned Competitions, qualifying events for World Aquatics Competitions or Olympic Games in Swimming and Open Water.



In order to present an accurately updated publication of the List of Approved Swimwear, Applicants shall notify to World Aquatics, about (i) formerly approved Swimwear which are discontinued. The discontinued and non-available Products will be removed from the List of Approved Swimwear.

## **7.5 Technical and Approval Implementing Rules for Swimwear**

Before any swimwear with a new design, Construction or Material is used in competition, the manufacturer of such swimwear must submit the swimwear to World Aquatics and obtain approval of World Aquatics.

The Swimwear and/or Material used must not put the health of the athletes at risk.

### **7.5.1 Swimsuits**

This section is related to Swimsuits used in Swimming and in Open Water Swimming Sports with a water temperature 18°C and above.

#### **7.5.1.1 Design**

##### **7.5.1.1.1 Decency**

The wearing of the swimsuit shall not offend morality and good taste (in particular, but not exclusively, because of the cut of the suit and body parts exposure whether covered or not).

##### **7.5.1.1.2 Shape (Surface covered)**

For swimsuits used in pool Swimming competitions:

Women's swimsuits shall not cover the neck or extend past the shoulders, or below the knee.

Men's swimsuits shall not extend above the navel or below the knee.

For swimsuits used in Open Water Swimming competitions:

Men's and Women's swimsuits shall not cover the neck, extend past the shoulder, or extend below the ankle.

Swimsuits fulfilling shape requirements for pool competitions comply a fortiori with shape requirements for Open Water Swimming competitions.

Please contact the World Aquatics Office with any cultural or religious concerns with the application of this rule.

##### **7.5.1.2 Structure / Composition / Other items**

Men's swimsuits are in one (1) piece.

Subject to observance of the decency rule and limitations of the body surface covered, women's swimsuits may be in one (1) or two (2) pieces.

Other items covering the body that are not part of the swimsuit are prohibited.

##### **7.5.1.3 Colours**

To avoid any doubt, colours will not be considered as part of the design. Colours can vary freely.

However, colour variations shall not affect compliance with any requirements and tested values.

##### **7.5.1.4 Material (general)**

###### **7.5.1.4.1 Type of Material**

The Material used for swimsuits can be only "textile Fabric(s)".

For the purpose of these rules, this is defined as Material consisting of, natural and/or synthetic, individual and non-consolidated yarns used to constitute a fabric by weaving, knitting, and/or braiding. It may be non-woven.

###### **7.5.1.4.1.1 Non-textile Material/elements/applications**

Non-textile Material/elements/applications can be used on seams in the following cases:

In "edge seams" including in particular "grippers", to ensure holding functions, e.g. through silicone strips and/or elastic cord(s).

In waistbands and straps (e.g. elastic cord inside folded Material)

Use of glue to fix the seam or the corresponding reinforcement tapes

**7.5.1.4.2 Surface treatment of the textile fabric**

Any Material added on to the surface of the textile fabric (any part thereof) or processing of the same (e.g. coating, printing, impregnation, heating, calendaring etc.) shall not close the overall open mesh structure of the base textile fabric.

The treated Material shall further comply with all requirements specified in these rules and particularly in regard to thickness, permeability and flexibility which must be and remain compliant, both at production stage until finished product stage and when the swimsuits are in actual use.

The rules regarding surface treatment do not apply to seams (sawn, welded, taped, glued, etc.), markings (manufacturer and/or sponsor logos as permitted by the applicable competition rules: printed or affixed on the base Material) or labels (homologation or technical labels as permitted by the rules).

**7.5.1.4.3 Flexibility**

The Material shall be flexible and soft folding.

**7.5.1.4.4 Regular flat Material**

The Material shall be regular and flat.

The Material shall not form outstanding shapes or structures, such as scales.

A thickness variation of the Material is permitted provided the thinnest point should not be less than 50% of the thickest point.

The overall thickness limitation (0.8 mm) shall in any event be respected at the thickest point(s).

**7.5.1.4.5 Variation of Material colours**

Variation of colours (or country-colours design) of the same Material is possible as long as the colouring does not affect compliance with tested value limits. Manufacturers are fully responsible to ensure that requirements in respect of all tested values (permeability, thickness, etc.) are respected in any colour variation.

Accordingly, the applicants may, but are not obliged, to submit Material samples for all colours variations they may intend to use for a particular model. However, the Material samples provided must be consistent with the submitted swimsuit sample.

**7.5.1.4.6 Surface treatment**

No outside treatment shall be added on the Material.

**7.5.1.4.7 Variety of Materials**

Different materials may be used in one swimsuit provided that all materials are textile fabrics as defined above and that the swimsuit complies with all other criteria.

**7.5.1.4.8 Combination/inside layer**

A combination of a maximum of two (2) layers of Materials is permitted. An exception is possible for period-proof swimsuit (see Part One – Rule 7.5.1.6.2).

The combination of layers shall not create outstanding shape(s) or structure(s). An inside layer of Material can be used notably for comfort, protection of sensitive parts or decency.

Permeability and thickness of layered Materials shall be measured on both layers as combined together and the combination of layers must thus comply with thickness and permeability requirements as set forth in these rules in all parts of the swimsuit.

For the testing, applicants must provide unbound sample of each Material. The fabric samples submitted for approval shall be cut in the principle direction of the yarns/fabric (in the direction of the roll of Material).

**7.5.1.5 Measurements of the Material****7.5.1.5.1 Thickness**

The total thickness of Material(s) used shall have a maximum value of 0.8 mm.

The thickness of layered Materials is the total thickness of both layers measured together.



It is clarified that this maximum thickness does not apply to seams as far as the seams are functional, and their thickness and width are the result of their natural functions.

The measurement procedure for thickness is described in the Testing Section (Part One, Article 7.5.6.1).

#### **7.5.1.5.2 Permeability**

Material(s) used must have at any point (except on seams, logos or labels) a permeability value of more than 80 liters/m<sup>2</sup>/second.

Permeability values are measured on Material with a stretch in the principal directions of the fabric of 25%.

However, measures on Material which cannot be significantly stretched will be carried out on unstretched, flattened Material.

Permeability of layered Materials is the permeability of both layers measured together.

The measurement procedure for permeability is described in the Testing Section (Part One, Article 7.5.6.2).

Permeability will not be tested on seams, provided they are considered as legitimate and functional seams.

#### **7.5.1.6 Construction**

No zippers or other fastening system is allowed.

Seams shall be limited to functional systems and shall not create outside shapes.

Use of seams (notably number, overall length, and disposition) shall not affect compliance with the requirements set forth herein.

External stimulation or influence: swimsuits which include any system providing external stimulation or has an influence of any type (including pain reduction, chemical/medical substance release, electro stimulation etc.) are prohibited.

#### **7.5.1.6.1 Seams and function**

Swimsuits include various elements which have a joining, binding and/or finishing function (seams).

Seams must remain limited to functional purposes. The use of seams shall not affect compliance with requirements. However, the seams themselves are exempted from the application of the thickness rule and the permeability is not measured on seams.

##### **These seams include:**

- Seams in the narrow meaning of the word (i.e. the element binding different parts of continuous Material).
- Edge Seams at the edges of the swimsuits.
- Grippers, i.e. edge seams which hold the legs of the swimsuits in place and.
- Waistbands holding jammers or briefs.
- Further Straps may be used to hold the upper part of women bodysuits.

All these elements have a specific construction (i.e. glued or welded seams, use of folded Material, use of elastic bands or silicone or similar strips) which is different from the sole use of textile Material. In each case, the functionality of the seams will be evaluated according to the above definition including grippers, waistbands and straps. Without prejudice to decisions in specific cases regarding these elements, the following principles will be taken into consideration.

#### **7.5.1.6.1.1 General principles**

The below is provided for guidance only and without prejudice. The decision will be based on an overall evaluation of the individual swimsuits. The purposes of the seams are:

- To join together the elements of the swimsuit = seams
- To finish properly the swimsuit at its edges = edge seams
- To prevent the swimsuit legs to slide = grippers
- To hold a jammer or brief = waistband
- To maintain the upper part of a women's bodysuit = straps

The seams must be fit for the above purposes and shall have no other function.



The elements described in Part One, Article 7.5.1.6.1.2 and Part One, Article 7.5.1.6.1.3 will be considered in this respect:

#### 7.5.1.6.1.2 Width

- Joining/Bonding seams shall not exceed 10 mm.
- Reinforcement/protection tapes such as those used to form or cover welded seams shall not exceed 20 mm.
- Edge seams and grippers shall not exceed 20 mm.
- Waistbands shall not exceed 25.4 mm (= one inch).
- Straps, or combination of straps, shall not exceed 50 mm.

In case of seams based on a technique using glue and a covering tape (notably to take into account overspill or irregularities in the treatment), the glued area is part of the seam (bounding area) and must remain within the maximum width.

#### 7.5.1.6.1.3 Number of seams

Excessive number of seams is prohibited.

Development in regard of seams will be carefully observed. The Independent Swimwear Expert reserves the possibility to intervene against excessive or non-functional seams.

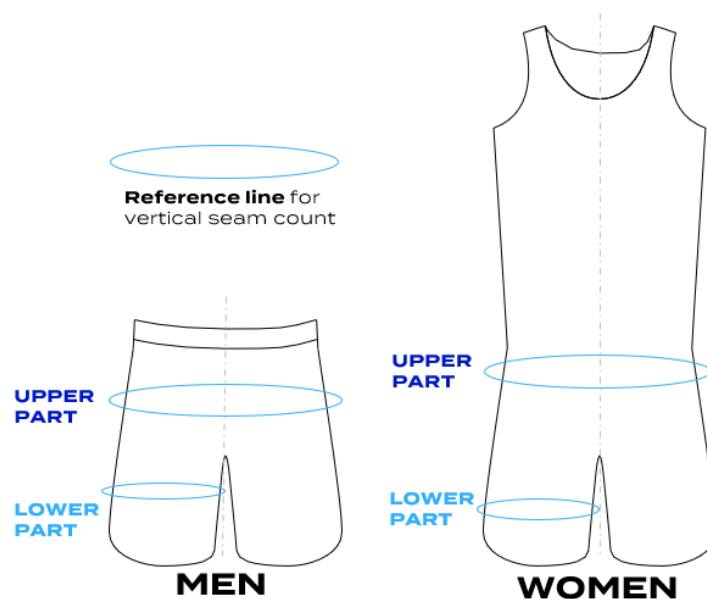

The authorised number of seams are:

For the upper part (above the crotch area):

- 9 seams for Men swimsuits,
- 11 seams for Women swimsuits.

For the lower part (below the crotch area):

- 4 on each leg for both Men and Women suits.

When two (2) or more seams are combined or merged, they count as two or more different seams in any area where their combined width is above the maximum width of a seam.

The reference line is always horizontal.

The total number of seams is the sum of the full circumflex.

#### 7.5.1.6.2 Swimsuit with period-proof element

A Product may exist in regular version and in a period proof version.



The coverage of the period proof element shall be strictly limited to the zone of the groins area (Inguinal area). The front area shall be at maximum 150 mm and the rear coverage of a maximum of 100 mm (seams included). A third fabric could be authorised for the period proof element.

In the case of additional period-proof fabric, the thickness of this specific combination must be equal or below 2.5 mm.

No specific permeability value is required for this area/combination in the case of period-proof model.

Clarifications related to approval of period-proof Product.

If the regular version of a period-proof Product has already been approved during a previous submission, a simplified approval procedure can be applied.

If the period-proof Product is considered compliant and approved, the Product will be immediately included in the current List of Approved Swimwear.

The normal administrative fees apply.

## **7.5.2 Wetsuits**

This section is related to wetsuit used in Open Water Swimming competitions with water temperature below 18°C.

### **7.5.2.1 Design**

Wetsuits shall completely cover torso, back, and thighs. They shall not extend beyond the neck, wrists and ankles.

The body parts, after the shoulder and/or below the thigh do not necessarily need to be covered.

### **7.5.2.2 Composition**

Wetsuits for both men and women shall be in one (1) piece.

### **7.5.2.3 Type of Material**

Material used for wetsuits must have thermal insulation properties (for example foam of polychloroprene (Neoprene) or of polyurethane or other Material with similar insulating properties).

*Note: The thermal insulation properties are not controlled nor tested in the approval procedure. The approval does not constitute any warranty or confirmation by World Aquatics and/or the Independent Swimwear Expert, of the capacity of the approved wetsuits models, when used, to effectively protect the swimmers from low temperature.*

The Material can be multilayered, with non-water permeable layers.

The Material cannot contain injected gas.

Material without insulating properties cannot be used.

### **7.5.2.4 Measurement of Material**

#### **7.5.2.4.1 Thickness**

The thickness of Materials used shall be minimum 3 mm and maximum 5 mm.

Provided the insulating functions are not prejudiced, the Applicant may apply for lowering of the minimum thickness value in limited specific areas, if such is functionally justified to allow free swimmer's movements. A decision in this respect is made at the Independent Swimwear Expert's discretion and cannot be challenged.

#### **7.5.2.4.2 Permeability**

Permeability is not measured.

#### **7.5.2.5 Construction**

Zippers or other fastening systems are allowed without specific limitations.





Zippers and fastening systems must be functional.

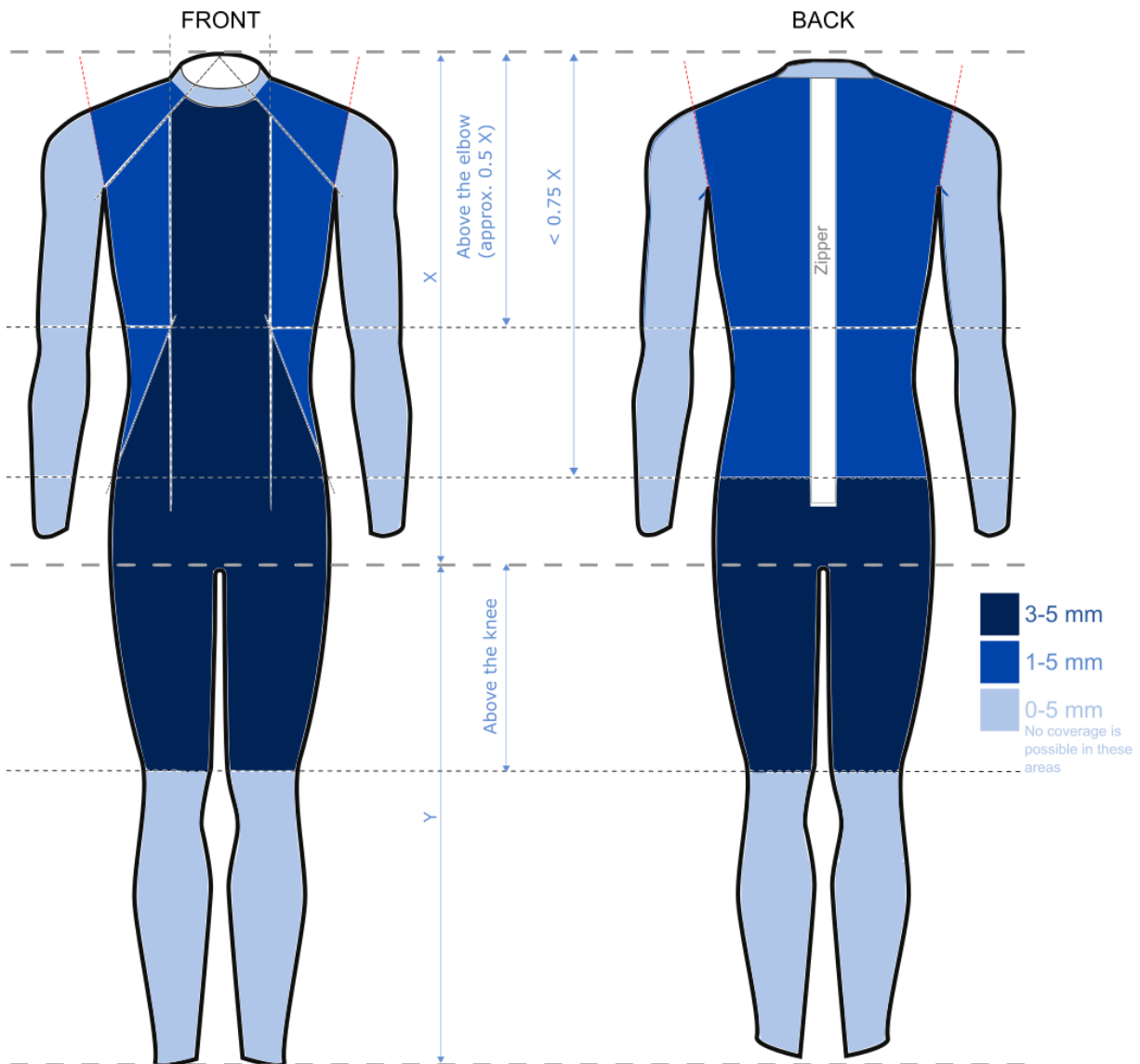

The table below gives a guideline to the manufacturers with regards to Material (total thickness) ensuring that the final thickness on finished garments is compliant:



Chosen Nominal Material Thickness (mm)	Fabrication tolerances (+/- %)	Upper / Lower bound (mm)	Measurements tolerances (+/- mm)	Upper-Upper / Lower-Lower bound (mm)	Rounded limit values (mm)	Reached limits
	<b>10</b>		<b>0.20</b>			
<b>For max. 5.00 mm</b>						
			Upper/Upper bound	4.60	<b>5.00</b>	<b>Max. thickness OK</b>
	Upper Bound	4.40	Upper/Lower bound			
<b>4.00</b>						
	Lower bound	3.60	Lower/Upper bound	3.80		
			Lower/Lower bound	3.40		
<b>For min 3.00 mm</b>						
	Upper Bound	3.85	Upper/Upper bound	4.05		
			Upper/Lower bound	3.65		
<b>3.50</b>						
	Lower bound	3.15	Lower/Upper bound	3.35		
			Lower/Lower bound	2.95		
<b>For min 1.00 mm</b>						
	Upper Bound	1.65	Upper/Upper bound	1.85		
			Upper/Lower bound	1.45		
<b>1.50</b>						
	Lower bound	1.35	Lower/Upper bound	1.55		
			Lower/Lower bound	1.15		
					<b>1.20</b>	<b>Min. thickness OK</b>

### 7.5.3 Caps

This section is related to swimming cap used in Swimming and in Open Water Swimming Sports.

#### 7.5.3.1 Design

The cap is an Independent item.

The cap shall not be attached to the swimsuit, wetsuit or goggles nor be in continuity therewith (i.e.no "hood" or "mask" effect).

##### 7.5.3.1.1 Shape

The shape shall follow the natural form of the head.

##### 7.5.3.1.2 Surface

The outer surface shall not include outside artificial shaping such as rigs or spoilers and similar.

##### 7.5.3.2 Material

###### 7.5.3.2.1 Hardness

No hard Material (Material can have some rigidity but shall be able to follow the shape of the head: no hard helmets).

###### 7.5.3.2.2 Type of Material

Different types of Materials may be used on the same cap.

The Materials can be of different thicknesses, subject to respect of the maximum thickness (see below). However, differences in the thickness shall not be used to form shapes in the outer surface.

*Thickness:* The maximum thickness in all points shall be lower or equal to 2 mm.

##### 7.5.3.3 Construction

Seams, if any, shall be functional and shall not create outside shapes.

##### 7.5.3.4 Colours



To avoid any doubt, colours will not be considered as part of the design. Colours can vary freely. However, colour variations of the cap shall not affect compliance with the above requirements.

#### **7.5.4 Goggles**

##### **7.5.4.1 Design**

The goggles are an independent item.

The goggles shall not be attached to the cap nor be in continuity therewith (no "mask" effect).

##### **7.5.4.2 Material/construction**

##### **7.5.4.2.1 Safety standards and functionality**

The goggles shall comply with prevailing safety standards for eyewear. Goggles have the function to protect the eyes against water and ensure visibility. Their design or construction shall serve these functions and especially shall not seek to obtain aquadynamic advantages (e.g. through extended shapes not related to the above functions). No sharp edges are allowed.

##### **7.5.4.3 Colours**

To avoid any doubt, colours will not be considered as part of the design. Colours can vary freely. However, colour variations of the goggles shall not affect compliance with the above requirements.

#### **7.5.5 Approval Procedure**

##### **7.5.5.1 Submission**

##### **7.5.5.1.1 The Applicant**

The Applicant shall be the company which actually markets the corresponding Swimwear to its end-users through customary sales channels (wholesalers/retailers/direct sales), respectively sells and/or supplies the same to competitors and teams.

Manufacturers acting as subcontractors for one or more other companies cannot apply for approval of the swimwear supplied to other companies.

If a specific model is manufactured and supplied to different companies which then market or supply it, an approval shall be requested by each of these different companies, irrespective of the fact that the models marketed or supplied by these companies may have the same manufacturing sources.

##### **7.5.5.1.2 Products to be submitted**

Please refer to the Part One, Articles 7.1 and 7.2.

##### **7.5.5.1.3 Application**

The Application Protocol is described on World Aquatics' website [HERE](#).

##### **7.5.5.1.3.1 Simplified Application for Goggles**

Goggles that are certified ISO 18527-3:2020(E), and comply with the requirements of the Part One, Article 7.5.4, may be approved through a simplified application process.

A sample with the Declaration of Conformity shall be sent to World Aquatics for the records. No review by the testing laboratory will be necessary and the manufacturer shall pay an administrative fee. The approval will be immediately effective at reception of the payment and the sample.

##### **7.5.5.1.4 Submission Dates**

There is no longer submission deadline.

A Swimwear can be submitted any time during the year.

A Swimwear must be approved no later than thirty (30) days prior to the start date of the first applicable Competition at which the Swimwear will be used.

##### **7.5.5.1.5 Contribution to Administrative and Expert / Testing Costs**

A contribution to the administrative and expert/testing costs will be charged to the Applicants for each application, including resubmission.



The applicable contribution will be based on the number of Products and Materials submitted with each application and will include the fees:

- for each Swimwear submitted (swimsuit, wetsuit, goggles, caps);
- for each Material submitted (for the same Material used in different models the fee is calculated only once);
- for each combination of Materials/double layer (for the same combination used in different models the fee is calculated only once); and
- for resubmission of a Product and/or Material.

Applications effected without corresponding fee payment will not be considered.

Any additional costs associated with the application (e.g customs clearance fees charged to World Aquatics, etc.) will be re-charged to the applicants.

#### **7.5.5.1.6 Technical Testing**

Technical testing and examination, as needed, is conducted under direction of the Independent Swimwear Expert and the professionals appointed by World Aquatics.

Information related to the test results of specific Samples are communicated to the Applicant concerned, upon request. No results are communicated to any other third party.

The only results relevant for the approval procedure of Swimwear are those obtained by the Independent Swimwear Expert, from the samples submitted with the application, or from additional Samples specifically requested by the Independent Swimwear Expert.

Measurements taken outside of that procedure on the same samples, or others, are not relevant for the Approval Procedure, irrespective of the equipment used.

#### **7.5.5.1.7 Examination by the Independent Swimwear Expert and Results of the submission**

The decision is reported in writing by World Aquatics to Applicants within sixty (60) days from the date of effective payment of the administrative fees.

In the case of a decision not to approve a submission, the Independent Swimwear Expert identifies the ground(s) for non-approval.

#### **7.5.5.2 Resubmission**

##### **7.5.5.2.1 Resubmission of Products**

In the event that an application for a Product is not approved, the applicant shall re-submit the Product/Sample.

The Sample resubmitted shall be the same Sample as the previously submitted Sample, save for the modifications linked with the Independent Swimwear Expert's requirements. Resubmission cannot serve for new Products to be presented that are different from the ones initially submitted.

A Product may be re-submitted as many times as necessary to be considered compliant and to be eventually approved. It should respect the articles of the Part One – Article 7.5.5.1.3.

##### **7.5.5.2.2 Resubmission process**

The resubmission process shall be conducted in the same way as for the original submission process and the above provisions regarding submission apply *mutatis mutandis*.

An application shall be resubmitted for each concerned Product as per Part One – Article 7.5.5.1 and shall include reconfigured Samples with the changes as required by the Independent Swimwear Expert.

##### **7.5.5.2.3 Resubmission fees**

The fees remains the same than for a regular submission.

In the case the correction only requires minor examination, World Aquatics, at its own discretion, may not impose any fee.

#### **7.5.6 Testing**

##### **7.5.6.1 Thickness Measurement**

###### **7.5.6.1.1 Value**



Maximum value: equal or less than 0.8 mm

Minimum value: equal or superior to 50 % of maximum value

Tolerance: +/- 0.1 mm

#### 7.5.6.1.2 Equipment

The equipment consists of a reference plate, a disk (parallel to the plate) together with a test gauge capable of measuring the distance between disk and plate with an accuracy of at least 0.01 mm.

#### 7.5.6.1.3 Specifications

According to ISO 5084:

disk size 100 mm<sup>2</sup> +/- 1 mm<sup>2</sup>

(diameter 11.28 mm +/- 0.05 mm)

pressure 1 kPa +/- 0.01 kPa

#### 7.5.6.2 Permeability

##### 7.5.6.2.1 Value

Minimum Value:

Equal or higher than 80 litres/square meter/seconds (l/m<sup>2</sup>/s)

Tolerance: +/- 5 % (in the range of Minimum Value)

##### 7.5.6.2.2 Measurement of air permeability

A flow of air is sucked through the fabric specimen, a tube system and differential pressure transducer. The unit measures the resultant differential pressure (proportional to volumetric flow), the absolute pressure and the medium temperature. The air permeability of the measured specimen is established based on those values.

The value of permeability is given in litres/m<sup>2</sup>/seconds (l/m<sup>2</sup>/s) for a given material.

##### 7.5.6.2.3 Measurement characteristics

- Measuring area: Diameter 25 mm.
- Differential pressure: 20 Pa
- Measuring range: 0-400 l/m<sup>2</sup>/s (high accuracy around Minimum Value)
- Definition of stretch: Uniform bidirectional and perpendicular stretch of 25% applied to the fabric (see sketch below)

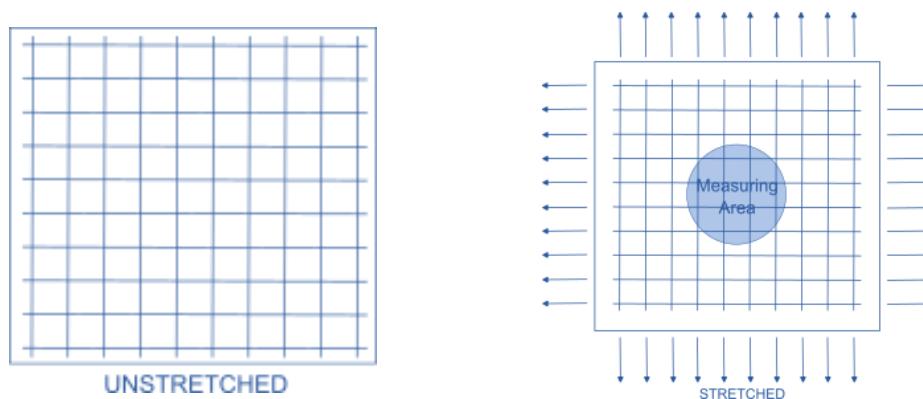

##### 7.5.6.2.4 Conditions

The swimsuit material is tested new and dry.

For accuracy purpose, repeatable tests will be done if the test value is close to the limit.

#### 7.5.7 Approval

**7.5.7.1 Validity of Approval****7.5.7.1.1 Approval**

An approval is valid upon its notification to the Applicant.

However, notwithstanding the above, approvals will be only effective, i.e. the corresponding swimwear may be used in World Aquatics' competitions and in any other Competitions and at the Olympic Games, from the date of publication of the current valid List of Approved Swimwear (Part One, Article 7.4).

The effective date is published on the World Aquatics' website [HERE](#).

**7.5.7.1.2 Availability****7.5.7.1.2.1 Availability**

The validity of the approval is further subject to the condition that the swimwear on the list has to be available on the market (available for purchase by any federations and competitors) but no later than thirty (30) days prior to the start date of the first applicable Competition at which it may be used, unless otherwise agreed in writing by World Aquatics.

Upon request, Manufacturers shall provide evidence of date of market availability.

If the Swimwear is not available, then the approval is temporarily suspended. The Swimwear is removed from the List of Approved Swimwear until the Manufacturer provides evidence of the availability of the new swimwear.

**7.5.7.1.3 Approval Changes**

Approvals granted remain valid until the relevant criteria for a category of swimwear is changed.

Irrespective of change in the criteria, which will impact on approval as they come into force, the validity of the approvals may however be subject to a maximum period of validity.

If a maximal period of validity is implemented, the concerned swimwear may be resubmitted for re-approval. The rules will provide for a simplified re-approval process.

In the event of introduction of new or amended criteria, all swimwear affected by the application of these changed criteria are subject to re-approval. The Independent Swimwear Expert may however exempt certain types or categories of already approved swimwear from a re-approval. The conditions of such exemption will be decided by the Independent Swimwear Expert. These conditions decided are not subject to any review or challenge.

**7.5.7.2 Homologation****7.5.7.2.1 World Aquatics Homologation Marks**

The athletes attending World Aquatics-sanctioned competitions must wear the World Aquatics Approved Swimsuits or Wetsuits. The Swimsuits and Wetsuits are subject to be checked by the officials at the occasion of an event.

The Applicant must use the World Aquatics' Homologation Mark in order to indicate that the Product in use has been approved. The Homologation Mark shall be placed in a position allowing easy control when worn.

All Swimsuits of the models-shapes and Wetsuits approved by World Aquatics shall bear appropriate Homologation Mark. Each Homologation Mark corresponds to particular model-shape of the Swimsuit or Wetsuit approved by World Aquatics.

If the swimsuit is in two pieces, each piece shall bear a mark. The marks should be printed or affixed to the swimsuits in a manner ensuring that they cannot be removed without destroying the mark (to prevent transfers).

World Aquatics will provide Applicants with a World Aquatics Homologation Mark for each approved Product (currently it applies to Swimsuit and Wetsuit, but may be extended to other swimwear in the future). The Homologation Mark carries a unique identification number.

Applicants must accept and certify to apply the Homologation Mark strictly and only on Products identical to, and fully consistent with, the actual Samples submitted to obtain the approval.

**Clarifications related to the homologation label**

For Open Water Swimming competition, it is clarified that wetsuits which fulfil the shape requirement can be accepted even if they do not bear a valid World Aquatics Homologation Label provided they effectively and evidently fulfil the requirements of the present Technical & Approval Implementing Rules. This is notably the case for swimsuits made of traditional permeable textile (i.e. open mesh) Material (such as cotton, Nylon, Lycra and the like) with no application of surface treatment closing the open mesh structure and Wetsuits which expressly fulfil the thickness requirement.

The Applicant is entitled to produce the Homologation Mark according to the specifications provided by World Aquatics.

The technical details (size, colors, design) of the Homologation Marks and World Aquatics Approved Package Tag are available on a separate document.

**7.5.7.3 Consistency and Compliance****7.5.7.3.1 Consistency**

The Products that are manufactured and used shall fully correspond to, and be consistent with, the Samples submitted to the Independent Swimwear Expert for obtaining the necessary approvals. Inconsistency found in the Products may lead to withdrawal of the approval (see Part One, Article 7.5.7.4).

All the parameters measured and recorded during the Approval Procedure notably values for permeability and thickness, are applicable to the Material(s) used in the finished Products and must remain in any event within the limits set under the requirements set in these Technical & Approval Implementing Rules.

The Applicants shall certify and be responsible for the fact that the Swimwear they manufacture and bring on the market as approved Swimwear (and bearing Homologation Mark), are fully consistent with the Products and the actual Samples submitted for approval.

Approved Swimwear shall not be modified, treated or processed in any way after their production. Any modification before use such as and including impregnation is prohibited.

**Clarifications related to the modification**

If a swimsuit or a wetsuit is modified or repaired by the athlete or any other person (e.g. by adding a new piece of fabric, or by repairing a seam, etc), the amended swimsuit/wetsuit will no longer be approved swimwear and will lose its approval/homologation. As a consequence, the athlete will not be allowed to use it during a competition listed in Part One – Article 7.1

**7.5.7.3.1.1 Clarification regarding consistency and minor modifications of Approved Swimsuits models.**

The principle that swimsuits which are effectively manufactured and used shall be and remain fully consistent with the corresponding approved model is an essential element of the approval system under the current regulations.

- **Modifications of approved models are as a rule excluded.**

However, minor modifications done by the Manufacturer of the model which do not affect essential features may be exceptionally allowed by the independent swimwear expert, based on a reasoned application of the Manufacturer and when the modification(s) appear(s) to be needed.

The minor modification is to address issues, which had not been identified prior to full manufacturing stage and actual use of the swimsuits (e.g. swimsuits breaking due to too weak seams, material transparent when worn, necessity to protect sensitive parts with lining, discontinued Materials, etc.).

It is clarified that the exceptional acceptance of modifications shall not be used to submit improvements of approved swimsuits models.



Material improvements of existing models are normally to be submitted through new applications in the course of the normal approval process.

- **The decision to allow the modification(s) or not is at the entire discretion of the Independent Swimwear Expert, and is not subject to any challenge.**

The above applies *mutatis mutandis* in relation with wetsuits, caps and goggles.

The Applicant must expressly confirm that the modification(s) has (have) not been implemented yet in regard to swimsuits already in use and must also confirm that, in case the modification(s) is (are) approved, only the modified models will be henceforth manufactured and distributed.

The applicable limits in regard of tested values and all other requirements and criteria must be observed in any event. If tests have to be performed (for example, use of a different lining), the Manufacturer will have to bear the corresponding costs. Advanced payment of the costs may be required as a condition to handle the application.

In the event, modification(s) of an approved swimsuit model is (are) accepted, the corresponding samples will be kept as new reference for the concerned approval number. If swimsuits consistent with the initial submission are in use, the initial samples will be kept as well.

#### **7.5.7.3.2 Compliance**

Compliance checks can be done by World Aquatics at any time on swimwear presented as approved in competition or otherwise.

Upon request of World Aquatics, the Applicant shall deliver additional Samples of approved Products as brought on the market for compliance checks.

#### **7.5.7.3.3 Control during Competitions**

##### **7.5.7.3.3.1 Before the race starts**

The Technical Officials or the World Aquatics' designee may check the compliance of the swimwear in the call-room.

If the swimwear is not compliant, the swimmer may not be allowed to take part in the race, or may be offered the opportunity to use another Approved Swimwear (at the swimmer's charge).

Swim Caps that comply with the technical requirements set in Part One, Article 7.5.3, and subject to the discretion and approval of the competition's Technical Officials or the World Aquatics' designee, may be exceptionnaly accepted for a particular race.

Goggles that comply with the technical requirements set in Part One, Article 7.5.4, and subject to the discretion and approval of the competition's Technical Officials or the World Aquatics' designee, may be exceptionnaly accepted for a particular race.

In addition, at the request of World Aquatics' designee, swimmers may be requested to submit their swimsuits for out-of-competition testing.

##### **7.5.7.3.3.2 After the race**

Swimwear may be inspected following the completion of a race by the World Aquatics' designee.

The competition results achieved with non-compliant Swimwear, and in particular with tested values (thickness or Permeability) non-compliant with the values mentioned in these Rules are subject to disqualification.

The disqualification of results applies to the results achieved at the race (refer to Specific Definitions) after which the control was conducted or otherwise determined.

The concerned competitor and/or the concerned Applicant shall be heard prior to issuance of the decision.

The application of the articles Part One - Article 7.5.7.4 is reserved.

#### **7.5.7.4 Withdrawal of Approval**

The validity of an approval is based on the fact that any and all the products brought on the market as World Aquatics approved swimwear, are fully consistent with the models and the actual Samples submitted to obtain the approval.





Upon request of World Aquatics, the Applicant shall deliver additional Samples of approved Products as brought on the market for compliance checks.

If swimwear presented as an Approved Product are found, during competitions or otherwise, to be not fully consistent with the Products and the actual Samples submitted for their approval (and this is not linked with modifications made outside the control of the Applicant), the approval may be withdrawn.

The decision to withdraw the approval will be issued by World Aquatics or by its designee after having heard the Applicant concerned.

In case of necessity (e.g. major event in course), the Executive of World Aquatics may provisionally suspend an approval before hearing the concerned Applicant.

#### **7.5.7.4.1 Withdrawal fee**

A withdrawal fee of ten-thousands (10'000) USD - per product will be due by the concerned Applicant.

The payment for withdrawal should include the Withdrawal fee as well as all related costs beard by World Aquatics, including but not limited with cost of purchased samples, cost of expertise, laboratory tests and required consultancy.

Furthermore, any new or pending application(s) by an Applicant will not be considered until the resolution of the case.

#### **7.5.7.4.2 Re-approval**

Application for re-approval for a withdrawn Product is to be effected through the normal process for approval and the application will be held as a new submission and handled accordingly.

As a condition for re-approval, the concerned Applicant shall bring evidence supporting the fact that it will guarantee consistency between Samples and Products effectively on the market.

#### **7.5.7.5 Customisation**

No customisation of a standard Product is permitted.

Individual body fitting (tailor-made Products) is authorized:

- a) if the service is accessible on the market to any athletes;
- b) Materials, Construction and Configuration of the tailor-made product are identical to the standard Product;
- c) the adjustment can only be done by the Manufacturer at the time of the production of the Swimwear (e.g. a standard Product cannot be untucked to be adjusted).

#### **7.5.7.6 Exemption of formal Approval**

The Independent Swimwear Expert, or World Aquatics' designee may issue an exemption from formal approval in respect to swimwear which can be determined as obviously compliant following general and easily checked objective criteria.

#### **7.5.8 Exclusion of Liability / Indemnity**

##### **7.5.8.1 Exclusion of liability**

To the full extent permitted by law, the Applicant expressly waives any claim against World Aquatics, its officers, employees, Independent Swimwear Expert and/or any Committee Members arising out or in connection with the approval process set forth in these provisions.

##### **7.5.8.2 Indemnity**

The Applicant shall indemnify and keep World Aquatics, its employees, and/or the Committee Members harmless against claims, damages or costs (including reasonable attorney's fees) arising out of or linked with claims by third parties based on the approval of Applicant's Product(s) and/or use by the Applicant of the approval notice.

#### **7.5.9 Arbitration**

Any dispute or decisions in connection with an approval procedure or otherwise in connection with approvals pursuant to these rules shall be exclusively submitted to the Court of Arbitration for Sport (CAS) in Lausanne in accordance with the CAS arbitration rules.



Disputes over payments of less than hundred-thousands (100'000) USD - shall be submitted to a single arbitrator. Swiss law shall apply as substantive law.

For the avoidance of doubt, criteria set forth in these rules shall not be subject to review. The same apply to conditions for exemptions.

#### 7.5.10 **Specific Definitions**

**Construction:** the act or result of putting different things together

**Configuration:** an arrangement of elements in a particular form, figure, or combination

**Independent Swimwear Expert:** Means a biomechanical or other suitably qualified independent expert

**Material:** all physical material/fabric used to produce every element of the swimwear.

**Product:** Piece of swimwear of a certain design/shape/material (to give examples: men classic, women closedback, goggles, cap, etc...). The end result of the manufacturing process, to be offered to the marketplace to satisfy a need or want. Considering that the product is the end result of the manufacturing process it can consist of one or many elements. All the elements of the product have to be fixed, attached to each other and have to have practical meaning according to the product functionality.

**Product Line:** The number of products that have similar construction and only vary in colours, sizes and shapes. Any variation in colours, shapes and sizes should not lead to any change of physical/technical parameters of the material the product consists of.

**Examples:** One Product Line of the swimsuits can include number of products of different shapes such as: Classic (Men), Pants-Short (Men), Pants-Long (Men), Full-Knee (Men), Full- Long-Leg (Men), Classic (Women), Full-Knee (Women), Full-Long-Leg (Women) as well as any possible modifications of the basic shapes (Open/Closed back).

**Race:** a single race in Swimming (for ex. 50m Freestyle, 4x100m Freestyle Relay, etc.) or in Open Water Swimming (for ex. 10km, Team Relay, etc.)

**Sample:** A particular Product and/or a piece of material used in Product construction of Swimwear being submitted for the approval process.

**Swimwear:** a swimsuit, a wetsuit, a swim cap or goggles.

## 8 **ADVERTISING IDENTIFICATION**

**8.1** Advertising identification appearing on swimwear, pool deck equipment and official's uniforms at World Aquatics Championships and World Aquatics Competitions, with exception for World Aquatics Masters Championships, is permitted as mentioned under in this Section.

### **8.2 Swimsuits**

One (1) manufacturer's logo of a maximum size of 30cm<sup>2</sup> when worn. Where one-piece suits are used, two (2) logos of the manufacturer shall be permitted, one above the waist and one below the waist of a maximum size of 30cm<sup>2</sup> each when worn. These two (2) logos of the manufacturer shall not be placed immediately adjacent to each other. Where two-piece suits are used, the two (2) logos of the manufacturer shall be placed on one piece each. The manufacturer's logo has to be calculated taking into consideration the entire surface of the logo, as shown below:





One (1) sponsor's logo of a maximum of 30cm<sup>2</sup> when worn.

One (1) flag and one (1) country name or code of a maximum size of 50cm<sup>2</sup> when worn. Repetitions of the national flag, elements thereof or, the colours of the national flag, included as a design element of the swimsuit, shall not be considered under this rule.

**VISUAL PURPOSES ONLY – NOT TO SCALE**

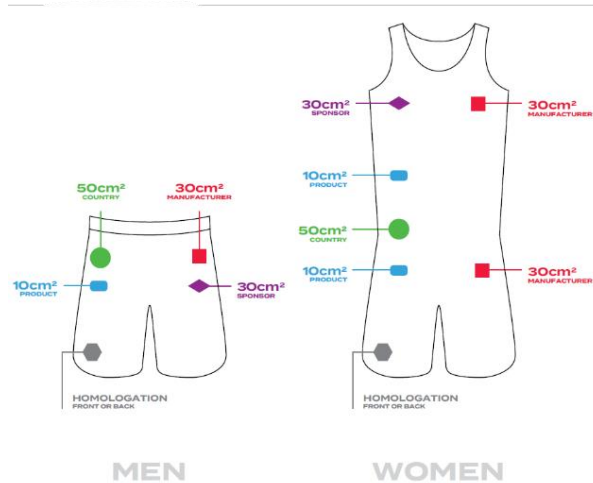

	<b>MANUFACTURER LOGO IDENTIFICATION</b>		<b>COUNTRY FLAG AND/OR COUNTRY NAME OR CODE</b>
	<b>PRODUCT TECHNOLOGY LOGO IDENTIFICATION</b>		
	<b>SPONSOR LOGO IDENTIFICATION</b>		

**HOMOLOGATION**

REFERENCE SIZES:  
a) 35x20mm (Height X Width)  
b) 35x27mm (Height X Width)



**8.3 Wetsuits**

The manufacturer's logo may appear on the front, and/or back, and/or sides of the wetsuit, of a maximum combined size of 80cm<sup>2</sup> when being worn. This manufacturer's logo space is allowed both on the inside and outside of the wetsuit. If the manufacturer wishes to have two or more logos on the front, back or sides, the combined total area must not exceed 80cm<sup>2</sup>. The size of the logo(s) shall be calculated taking into consideration the entire surface of the logo(s), as shown in the examples below:



One (1) sponsor's logo (may appear on the front of the wetsuit) of a maximum of 30cm<sup>2</sup> when being worn.

There must be a minimum clearance space of 1.5cm around all marks on the wetsuits, including any manufacturer's logo(s) and/or sponsor logo. There shall be no marks or design/graphic elements on the upper arm or shoulder articulation area of the wetsuits, to allow for the clear application of the competitor race number.

**VISUAL PURPOSES ONLY – NOT TO SCALE**

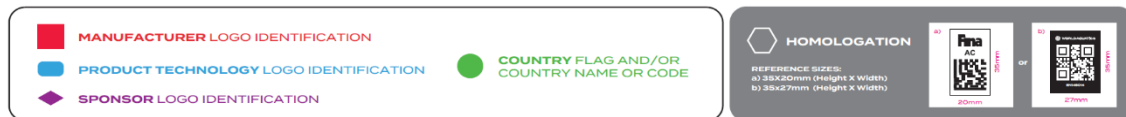
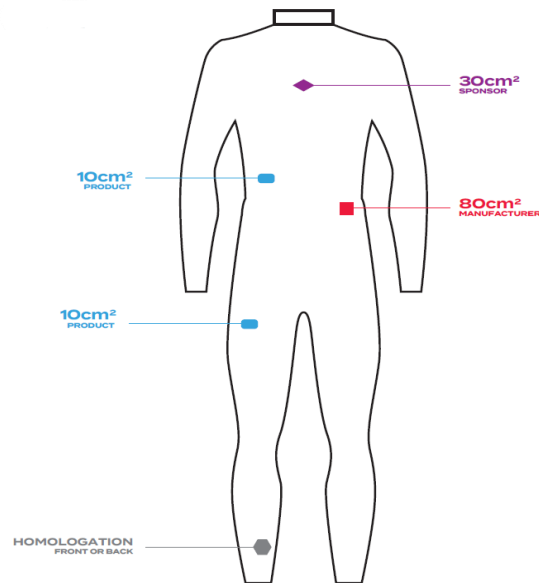

#### 8.4 Product Technology Identification

Where one-piece suits (swimsuits or wetsuits) are used in competition, two (2) Product Technology Identifications shall be permitted, one above the waist and one below the waist, of a maximum size of 10 cm<sup>2</sup> each when worn, however these identifications shall not be placed immediately adjacent to each other, nor immediately adjacent to any manufacturer's logo. Where two-piece suits are used, one Product Technology Identification may be placed on each piece.

Other clothing: One additional identification allowed on clothing, limited to Product Technology Identifications, with a maximum size of 10 cm<sup>2</sup>.

Product Technology Identifications means the technical identification (which shall not include any identification of the manufacturer, or any part thereof) used on clothing to identify any fabric technology.

#### 8.5 Swimming Caps

One (1) manufacturer's logo of a maximum size of 20cm<sup>2</sup> on the front.

One (1) flag and/or country name (code) of a maximum size of 32cm<sup>2</sup>. The side on which the flag and country name (code) shall be printed will be advised by World Aquatics.

For World Aquatics Championships one (1) World Aquatics Partner's logo on the right side of the size decided by World Aquatics on a case-by-case basis.

Note: Caps for Open Water Swimming are defined under Part One, Article 8.6.

**VISUAL PURPOSES ONLY – NOT TO SCALE**

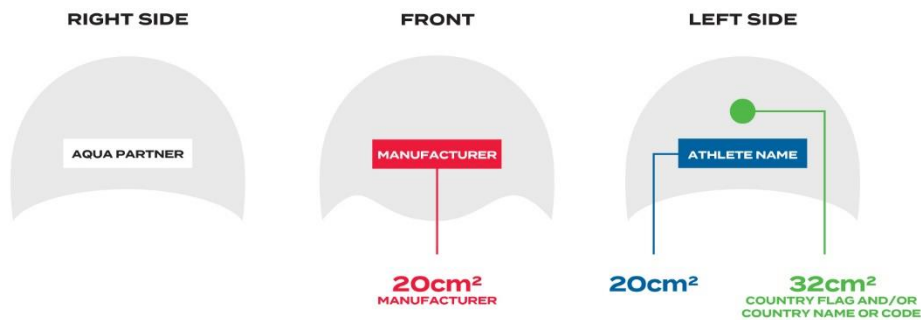

For World Aquatics competition, one (1) flag and/or country name (code) of a maximum size of 32cm<sup>2</sup> can be printed twice (meaning that the flag and country name can appear on both sides of the cap). This to be advised by World Aquatics whenever applicable. Competitor's name of a maximum size of 20cm<sup>2</sup>. The competitor's name shall be printed on the same side as the flag and country name (code). Printing the competitors' name isn't compulsory.

It is permissible to wear two (2) caps. Both caps must comply with the advertising rules.

### 8.6 Open Water Swimming Caps

In all Open Water events it is mandatory for the cap to display on each side the "national-three letter code" and may display the swimmer's national flag or the swimmer's name. The country code shall be a minimum of 8cm in height. Caps meeting the specifications of 1.8.5 are not acceptable except for one (1) manufacturer's logo of a maximum size of 20cm<sup>2</sup> on the front.

#### VISUAL PURPOSES ONLY – NOT TO SCALE

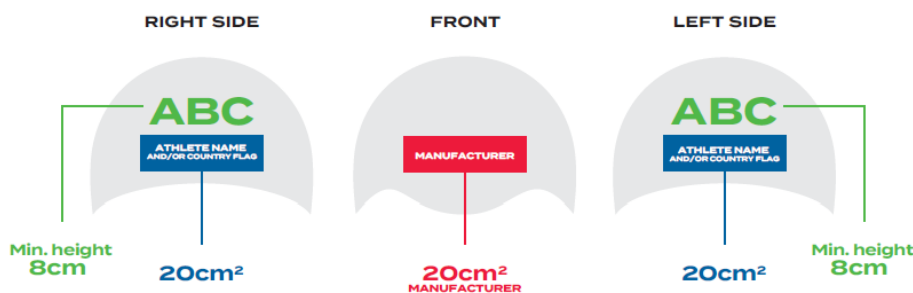

Athlete's name of a maximum size of 20cm<sup>2</sup>: The competitor's name shall be printed under the country name (three letter code). Displaying the competitor's name is not compulsory.

### 8.7 Water Polo Caps

- One (1) country code of a maximum height of 4cm on the front side of the cap.
- One (1) manufacturer's logo of a maximum size of 6cm<sup>2</sup> on the front, back or side.
- One (1) player number of a maximum height of 10cm on both sides of the cap.
- One (1) country flag of a maximum height of 4cm on the back side of the cap.
- One (1) sponsor logo (at the discretion of the National Federation) of a maximum size of 6cm<sup>2</sup> on the back side.

#### VISUAL PURPOSES ONLY – NOT TO SCALE

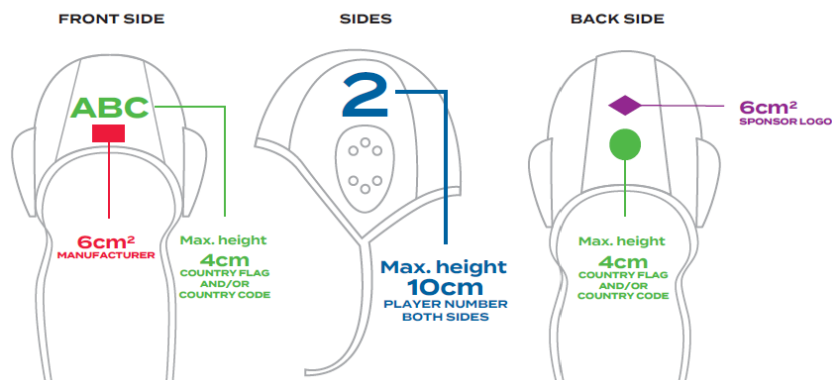

In addition to the above, please refer to Part Six, APPENDIX B.4.

### 8.8 Goggles

Two (2) manufacturer logos of a maximum size of 6cm<sup>2</sup> each are allowed on goggles but only on the spectacle frame or band.

### 8.9 Competitors Bibs

- The maximum size of the Bibs shall be 24cm (width) x 20cm (height).
- The height of the digits on the Bibs shall be no less than 6cm and no more than 10cm.
- The maximum height of the identification above the digits shall be 6cm.
- The identification may display the name/ World Aquatics Partner's logo.
- The maximum height of the identification below the digits shall be 4cm.
- The identification may display the name/logo of the Host City and the year.
- The Bibs shall be printed in suitable colours in order to ensure maximum visibility of the digits.
- The Bibs must be worn fully visible during Competitors' introduction and award ceremonies.

A Competitor removing the Bib before being presented at the start of an event or before completion of the medal ceremony may be disqualified.

Only one World Aquatics Sponsor may be displayed on Bibs. However, there may be one sponsor for men and another for women at the same Championships.

#### VISUAL PURPOSES ONLY – NOT TO SCALE



Bib	Presentation Semi-Final	Presenta tion Final	Award
SW	Yes	Yes (+ Relay)	Yes
DV	Yes	Yes	Yes
HD	Yes	Yes	Yes
AS	Yes	Yes	Yes
WP	N/A	N/A	Yes
OVS	N/A	N/A	Yes

Each competitor at World Aquatics Championships and World Aquatics competitions must wear on the chest over their tracksuit such advertising as supplied by World Aquatics when being introduced prior to the start of each event and during the medal ceremony.

### 8.10 Pool deck equipment

A maximum of three (3) advertising identifications (including manufacturer logo) with a maximum size of



40cm<sup>2</sup> each when worn for any of the clothing items listed below, and a maximum of two (2) advertising identifications (including manufacturer logo) with a maximum size of 6cm<sup>2</sup> each for any of the accessories and equipment items listed below:

Clothing items:

- Windbreaker
- T-shirt
- Polo shirt
- Casual shirt
- Sweat shirt
- Bath robe
- Pants
- Shorts
- Skirts

Accessories:

- Towels
- Baseball caps
- Hats
- Headphones
- Facemasks
- Jewellery
- Socks
- Footwear

Bags:

- Not greater than 10% of the surface area of the item to a maximum of 60 cm<sup>2</sup>.

Additionally, one (1) National Federation or NOC logo identification per item with a maximum size of 40 cm<sup>2</sup> for clothing items and 6 cm<sup>2</sup> for accessories may be displayed.

The placement of advertising identification on clothing and accessories is at National Federation's discretion, except for the designated bib area specified below and subject to World Aquatics' approval.

**VISUAL PURPOSES ONLY – NOT TO SCALE**



**8.11** Any body advertisement, in particular displayed on the competitor's body, is forbidden in any way whatsoever.

**8.12** Advertising for hard alcohol (greater than 15% alcohol), tobacco-based products, vapor-based smoking and sport gambling is prohibited. However, advertising for soft alcohol (less than 15% alcohol) and games of chance (e.g. state-sponsored lotteries) are allowed.



**8.13** Any advertising identifications which are not indicated in these regulations are not permitted. In the event that any clothing or other items of equipment contravenes these regulations, the competitor must immediately remove the offending item(s) and replace it/them with clothing that complies with World Aquatics Regulations. In the event that the breach is not immediately remedied the competitor may be requested to wear attire provided by the event organizer.

**8.14** World Aquatics reserves the right to request National Federations taking part in World Aquatics Championships and World Aquatics Competitions to present any advertising identification in this rule for examination and approval of World Aquatics prior to the event in question.

## **9 MEDICAL RULES**

**9.1** World Aquatics adopted the Olympic Movement Medical Code in 2008. All World Aquatics medical regulations, guidelines or protocols, follows the general principles of the Olympic Movement Medical Code.

The latest versions of the Olympic Movement Medical Code can be found on the IOC Medical and Scientific Commission website [HERE](#)

The Olympic Movement Medical Code applies to all athletes in the sports activities governed by World Aquatics, in competition as well as out of competition.

World Aquatics is free to grant wider protection to their athletes.

The Olympic Movement Medical Code applies without prejudice to the national and international ethical, legal and regulatory requirements that are more favourable to the protection of the health, rights and interests of the athletes.

### **9.2 Medical Requirement for World Aquatics Events**

#### Scope of Medical Coverage

The Organising Committee (OC) shall organise the medical care to cover any emergency issues, acute injury and illnesses of athletes and World Aquatics Family that may occur during the period of the World Aquatics Event and to respond to injuries and illness that arise to any one at the competition and non-competition venues.

#### Limits

This document describes planning and operational requirements for the OC Medical Services, and explains the obligations, responsibilities and planning processes.

However, it does not address how such medical services will be delivered during the period of the Event. This limitation recognises the variability of regulatory governance and clinician roles existing across the global medical community.

Chronic injury and illness are not covered by the OC Medical Services and World Aquatics is not responsible for any failure to diagnose or treat any chronic injury or illness.

#### Date of Operations

Athlete medical services must be provided on all days of official training and competition, beginning one hour before training or competition begins.

#### References

These requirements contain numerous elements, information, and references from:

- IOC Manual of Emergency Sport Medicine, 2015, McDonagh D. and Zideman. D.
- ASOIF Health Care Guidelines for International Federations, 2020

### **9.2.1 Background information**

World Aquatics is responsible for the aquatic sports of Swimming, Artistic Swimming, Diving, High Diving, Water Polo and Open Water Swimming.





- While aquatic sports are generally quite safe from a medical perspective, there is obvious potential for drowning in all water-based sports. Each World Aquatics sport also carries the potential for injury unique to that sport, as summarised in the following section. Knowledge of aquatic sports medicine enables hosts of World Aquatics' events to consider the provision of appropriate clinical support in their planning.
- World Aquatics places the physical and mental health of athlete stakeholders as its top priority.

### 9.2.1.1 A guide to common injuries

<b>Swimming:</b>	overuse injuries
<b>Artistic Swimming:</b>	traumatic (contact) injuries, fainting (hypoxia) from breath-holding
<b>Water Polo:</b>	contact injuries
<b>Diving &amp; High Diving:</b>	high-velocity traumatic injuries
<b>Open Water Swimming:</b>	overuse injuries, traumatic (contact), cold and heat stress, skin irritation from UVL exposure or bites

### 9.2.1.2 Injury Profile

The literature on injuries to aquatic athletes characterise overuse injury as predominant, with the shoulder, knee and lower back as the most common injury sites. This mechanism of trauma is most common in swimming, secondary to repetitive use.

In terms of impact or contact injury, the head and face are the most vulnerable body sites in water polo and artistic swimming, while injuries to the digits (particularly fingers) are also possible.

Although relatively rare, high-velocity impact injuries are most common in Diving, particularly High Diving.

### 9.2.1.3 Essential skills required from the Medical Team

Given the above information, the medical team should have an understanding of aquatic sports medicine, with obvious proficiency in water rescue procedures.

### 9.2.1.4 Overview of Competition Planning

Effective planning for athlete health care must be based on a clear understanding of the size and scope of the World Aquatics Event. From a purely logistical standpoint, the medical plan must consider:

- The duration of the event
- The spread of venues (training + competition)
- Environmental conditions (outdoor – indoor)
- Number of participants

### 9.2.2 The Sports Medicine Committee

The Sports Medicine Committee (SMC) is responsible for advising on various medical aspects across each aquatic sport. The SMC comprises physicians with specialist expertise and wide clinical experience in all aspects of aquatic sports medicine.

The specified duties of the SMC are as follows:

- to provide specialist expertise to the Bureau in the form of recommendations on all matters relating to aquatic sports science, medicine and athlete participation following a medical incident;
- to ensure World Aquatics rules relating to athlete physical and mental health and well-being reflect current clinical best practices;
- to advise on venue suitability, where applicable, in relation to sanitation and water quality, submitting as necessary, timely updates to the Bureau;
- to ensure safety in all aquatic sports, recognising the unique characteristics of each sport; and
- to advise OC in the provision of appropriate medical care for World Aquatics athletes and Officials at World Aquatics Competitions.

#### 9.2.2.1 Roles and Duties

##### 9.2.2.1.1 Prior to World Aquatics Events



The SMC or its representative will liaise with the OC Medical Team to ensure adequate planning for the delivery of Medical Coverage.

The World Aquatics Medical Delegate appointed to an event may be briefed on the points to be checked during a World Aquatics Event.

#### **9.2.2.1.2 During the World Aquatics Events**

The World Aquatics Medical Delegate is responsible for oversight of all the medical aspects of the event ensuring the health, safety and well-being of athletes and officials. World Aquatics Medical Delegate(s) does not practise medicine during World Aquatics Events. They only have a consultative and expertise role.

The local Chief Medical Officer is responsible for delivering a medical plan as outlined in these World Aquatics Medical Requirements and the relevant regulations for World Aquatics events.

Important note: Checks carried out by the World Aquatics Medical Delegate are limited to the compliance with the World Aquatics regulations and do not shift the responsibility for the medical services from the organizer to World Aquatics.

Findings of non-compliance shall be notified to the LOC who shall take appropriate measures and remain exclusively responsible for the safety at the event under the World Aquatics rules and the terms of the organization agreement.

The World Aquatics Medical Delegate (or its designee) will:

- Liaise with the Chief Medical Officer before the event to ensure that an appropriate medical plan is in place in keeping with the World Aquatics Medical Requirements.
- Provide aquatic-specific knowledge and advice to the host medical teams as needed.
- Ensure, with the Chief Medical Officer, that the venue is free of significant risks or hazards.
- Ensure, with the Chief Medical Officer, that emergency transport, an emergency secondary care facility and After-Hours care are available.
- Ensure, with the Chief Medical Officer, that any public health requirements regarding communicable diseases are followed.
- Confirm that the Medical Treatment Area is suitably staffed and equipped
- Confirm that lifeguards are in place while athletes are in the water
- Liaise with the Chief Medical Officer on a daily basis to receive an overview of injuries and illness encountered.
- Confirm availability of water and snacks and, where appropriate, nutritious meals for the athletes
- Support the presentation of the medical plan at the World Aquatics Technical Meeting
- Be a person of contact for medical issues, pertinent to World Aquatics, for attending teams.
- Visit athletes (if authorised) who have been evacuated to medical care centres/hospitals
- Coordinate on-site research projects initiated by the SMC and World Aquatics.

#### At Open Water Swimming events

If present at Open Water Swimming events, the World Aquatics Medical Delegate will:

Liaise with the World Aquatics Safety Delegate, World Aquatics TOWSC Delegate and the local Chief Medical Officer regarding all aspects of participant safety at the competition venue.

Review the water quality results prior to arrival at the competition site, as well as subsequently from the day of the competition (if available).

Ensure, with the local Chief Medical Officer and World Aquatics Safety Officer, that the environmental conditions are acceptable for the competition, water quality and temperature in keeping with current published World Aquatics standards.

Ensure, with the local Chief Medical Officer and World Aquatics Safety Officer, that there are sufficient Medical Boats with medical staff (placed in the water with emergency equipment and supplies, including radio for communications), with a defined evacuation point/s to emergency medical support personnel and ambulance evacuation if necessary.

#### At High Diving events

If present at High Diving events, the World Aquatics Medical Delegate will:



Liaise with the World Aquatics High Diving Delegates and the local Chief Medical Officer regarding all aspects of participant safety at the competition venue.

If applicable, review the water quality results prior to arrival at the competition site, as well as subsequently from the day of the competition.

#### **9.2.2.1.3 After the Event**

The World Aquatics Medical Delegate will submit a post-event report on all medical aspects of the event, together with recommendations for future improvement.

### **9.2.3 Specific Medical and Safety Regulations**

#### **9.2.3.1 Concussion Protocol for any World Aquatics sport**

In the event of concussion or suspicion of concussion, the Sports Concussion Assessment Tool (SCAT) must be used to evaluate concussions. The SCAT is a standardized tool for evaluating concussions designed for use by physicians and licensed healthcare professionals. The SCAT cannot be performed correctly in less than 10 minutes. SCAT is to be used for evaluating athletes aged 13 years and older.

The latest version of SCAT and Consensus Statement on concussion in sport can be found here.

<https://bjsm.bmj.com/content/bjsports/57/11/622.full.pdf>

<https://bjsm.bmj.com/content/57/11/695>

#### **9.2.3.2 Decision-making on return to the competition following injury or other medical reasons**

Based on the recommendation of the Sports Medicine Committee and/or the OC Medical Team/local medical authorities, and in conjunction with the athlete and NF Medical Team, the Bureau, as per Constitution Rule IV.17.1, may remove an Athlete from an aquatics competition and/or take any other appropriate measure if such participation poses a risk for the health and safety of such Athlete or any competitors.

### **9.2.4 Medical Plan and Health Care**

#### **9.2.4.1 Medical Plan**

The OC shall submit a Medical Plan to World Aquatics for approval before the Event. The deadline to submit the Medical Plan will be defined in the Operational Requirements. The plan shall comply with all requirements of these Regulations.

Each Medical Plan shall be reviewed by the Sports Medicine Committee, who shall approve, modify, or reject the submitted Medical plan.

##### Implementation of the Medical Plan at the Event

The World Aquatics Medical Delegate (MD) shall inspect the competition venue with the OC Chief Medical Officer (CMO) or Venue Medical Officer (VMO) prior to the first day of training to ensure the adequacy of the medical/safety plan.

The World Aquatics Medical Delegate (MD), in cooperation with the Technical Delegate (TD) and the OC CMO or VMO, may modify, postpone, or cancel the competition whenever the approved safety plan is inadequate to protect the safety of athletes.

#### **9.2.4.2 OC Chief Medical Officer (CMO) and OC Medical Team**

The OC shall designate an appropriately qualified physician as a Chief Medical Officer (CMO) for the World Aquatics event as soon as the Event is confirmed by World Aquatics.

For World Aquatics Championships and World Aquatics Swimming Championships, the CMO shall be nominated twelve (12) months before the beginning of the Event.

She/He should have experience with Aquatic Sports preferably.

She/He must speak English.

This individual will be responsible for the following tasks:

- Organization of the complete medical care system
- Coordination of medical care personnel



- Ensuring the quality of the medical services and equipment
- Establishing an emergency care pathway
- Communication between the Chief Medical Officer and World Aquatics (Medical Department or SMC) is essential prior to the event to ensure adequate and appropriate planning for the medical needs of the competitive event.

The CMO is responsible to ensure that an adequate number of appropriately qualified healthcare personnel are available and hired for the training and competitive sessions of the World Aquatics event. Depending on the size of the Event, she/he may appoint a Deputy Medical Officer(s) and/or Medical Venue Manager(s) who can help the CMO with the duties.

### 9.2.4.3 Health Care Personnel (HCP)

For all training and competitive sessions, healthcare personnel should be available on-site whenever athletes have access to the venue. They should have some sports medicine skills or experience.

The numbers and type of HCPs will depend on the size of the event but shall include:

- Primary care / Sports Medicine Doctor
- Lifeguards
- Paramedics

In addition to the above, HCPs may also include:

- Nurses
- First aid responders
- Physiotherapists
- Massage therapists
- Athletic trainers

All World Aquatics Events should have trained and qualified lifeguards poolside for all training and competitive sessions. They will be responsible for any in-water retrieval of an athlete in difficulty.

At the World Aquatics Championships, it is recommended to have at least one English-speaking doctor assigned to each venue.

No training nor competitions could start without the presence of HCPs.

#### 9.2.4.3.1 Summary Table of recommended HCP

The recommended numbers hereafter only represent the staff that must be present on-site. To organise efficient shifts/turn-over, the total pool of recruited HCPs shall be larger, especially for long Events.

##### 9.2.4.3.1.1 Lifeguards

A minimum of two (2) lifeguards per swimming pool (competition pool or training pool) is required. Specific requirements are described in the medical section of each Sport Part in these Regulations.

The number of lifeguards should be increased proportionally to the number of athletes to cover multiple casualties at the same time.

Daily practice of water retrieval is recommended.

##### 9.2.4.3.1.2 HCPs - Single Sport Event

Venue	
Primary care / Sports Medicine Doctor:	1-2
Paramedics:	2
Nurse(s):	1
Physiotherapists:	1
Massage therapists:	1-2



Training Venue (if applicable)	
Paramedics:	1
Nurse(s):	1

**9.2.4.3.1.3 HCPs - Single Sport World Championships**

<b>Venue</b>	
Primary care / Sports Medicine Doctor:	2
Emergency physician:	1
Paramedics:	6-8
Nurse(s):	2-3
Physiotherapists:	1
Massage therapists:	1-2

<b>Training Venue (if applicable)</b>	
Primary care / Sports Medicine Doctor:	1
Paramedics:	1
Nurse(s):	1-2

**9.2.4.3.1.4 HCPs for Multiple Sports Event**

<b>Venue</b>	
Primary care / Sports Medicine Doctor:	4-5
Emergency physician:	2
Paramedics:	8-10
Nurse(s):	6-8
Physiotherapists	3-4
Massage therapists	3-4

<b>Training Venue (if applicable)</b>	
Primary care / Sports Medicine Doctor:	1
Paramedics:	1
Nurse(s):	1-2

**9.2.4.3.1.5 Psychologists**

The OC is strongly recommended to organise the availability of psychologist(s) on call if there is a demand from athletes or any participant.

**9.2.4.4 Roles and Duties of the LOC Medical Team**
**9.2.4.4.1 Prior to the event**

The Medical Team collaborates with World Aquatics in the planning of the medical program and provides different medical plans.

They shall undertake a sport & sport-specific medical risk assessment of all training and competition sites.

They shall provide a timeline and budget for the organisation of the medical program to the OC.

They should organise the medical training of the HCP. In addition, the CMO and/or the Medical Team may pilot the medical plan at local test events and evaluate and revise the plan as required.



The Medical Team will Liaise with public health authorities to plan event risk mitigation strategies. It shall publish and circulate the public health event risk mitigation strategies. The Medical Team shall ensure that all evacuation and fire procedures for the spectators and the athletes are in place as per local regulations.

The Medical Team will provide a list of common medications available/not available in the country and will assist the NF Medical Personnel with the drug and equipment importation regulations.

The Medical Team will assist the NF Team Doctor with their registration and licensing in the host country to provide medical services to their delegation during the World Aquatics Event. This could also be the occasion for the Team Doctor to inform the OC medical team (in confidence) of any pre-existing medical conditions for their athletes/personnel that may occur during training and/or competition and organise (in confidence) any specific/unique medical treatment that an athlete may require in the event of injury or illness.

It shall develop and test an electronic medical encounter system to be used during the Event. Train all members of the OC medical team to use the system.

#### **9.2.4.4.2 During the event**

The Medical Team shall:

- Implement the medical care program in collaboration with World Aquatics for all areas in venues.
  - Field of Play (FoP)
  - Athlete Medical Room
  - Spectator Medical Room
  - Athlete hotels/villages
- Undertake scenario-based practice of the FoP extractions and/or parts of the medical action plan on a daily basis.
- Undertake FoP initial assessment, treatment and evacuation from FoP and appropriate nationally/internationally recognised standards.
- Undertake medical care for athletes who do not have their own medical team healthcare professionals.
- Complete the required documentation for World Aquatics in a daily medical report.
- In collaboration with the World Aquatics Medical Manager, help facilitate the logistics and participate in the venue medical meeting.
- Support the NF medical teams in the provision of medical care for their athletes.
- Implement the World Aquatics safeguarding policies and procedures as applicable.
- Provide the relevant data for World Aquatics injury and illness surveillance/ audit, and/or other research projects.
- Ensure all relevant staff are familiar with the WADA Prohibited List and the requirements for Therapeutic Use Exemptions and Needle Policy (as applicable)
- Maintain medical confidentiality throughout the event.
- Implement the World Aquatics communication policy related to arising athlete health issues (as applicable)

#### **9.2.4.4.3 After the event**

The CMO and the Medical Team shall provide a detailed report to World Aquatics reviewing all aspects of the delivery of the medical care program in venues or at hotels/Athletes Village (if applicable).

They shall provide recommendations for improvements for future World Aquatics events and future organisers.

#### **9.2.4.5 Communication and Information**

##### **9.2.4.5.1 Between the LOC Medical Team**

During the World Aquatics Event, a reliable and confidential communication mechanism is essential to ensure clear and prompt communication between the members of the OC Medical Team.

The emergency transport vehicles shall be able to communicate directly with FoP Medical Team.

The communication system should have a dedicated, secure channel for the sole use of the medical team. A separated channel shall be dedicated for the medical team in charge of the spectators and the media.

##### **9.2.4.5.2 Between World Aquatics and LOC Medical Team**



During the Event, daily meetings shall be organised between the OC Chief Medical Officer and the World Aquatics Chief Medical Officer/Medical Delegate. It is the occasion to:

- Review reports from NFs, OC Medical Team and SMC members
- Review medical incidents and advise on appropriate action
- Provide expert advice regarding potential cancellation or rescheduling of an event in case of athlete health risk/safety (e.g., inclement weather)
- Provide expert advice and assistance to the OC medical team as required/requested

#### **9.2.4.5.3 Team Leaders Meeting for each sport**

Before each World Aquatics Event, a Team Leaders Meeting (TLM) is organised.

The Chief Medical Officer and the World Aquatics Medical Delegate shall be present to present the different aspects of the Medical Plan and Health Care. The safety topics to be included are for instance:

- explanation of the venue layout
- anticipated weather conditions (for outdoor venue)
- water temperature
- description of onsite medical support and availability of hospital care
- outline of evacuation plan

This meeting could be the occasion for the World Aquatics Medical Team to present any scientific research or initiatives organised by World Aquatics during the competition such as:

- Injury and illness surveillance/audit research project
- Other athlete health-related research projects
- The academic program (educational seminars) as learners or lecturers
- Safeguarding (harassment and abuse) rules and regulations

Procedure related to the Athlete withdrawals and substitutions for medical reasons shall be reminded during the Team Leaders Meeting.

#### **9.2.4.5.4 Special meetings**

Dedicated meeting(s) could be organised to address specific issues (e.g status of an epidemic during the Event).

#### **9.2.4.5.5 Medical Care Guide**

Information about the Medical Services should be included in the Event Summons, Information Bulletin and/or Team Leaders Guide.

#### **9.2.4.6 Athletes with no Team Physician**

The LOC Chief Medical Officer should provide medical care for those competitors whose teams do not have team physicians.

#### **9.2.4.7 Clear Identification and attire of the Health Care Personnel**

It is important that the HCP could be immediately identified on the FoP and at the venue.

It is understood in some countries the HCP may belong to different corporations and shall wear their official attire/uniform. However, when possible and in cooperation with the LOC, a distinctive uniform (e.g a polo shirt, a jacket, a bib) with a "lively" colour shall be provided to the OC Medical Team and HCPs.

#### **9.2.5 Venue Medical Services**

Any individual, if physically present at the venue, should be served by the OC Medical Programme. There should be separate medical stations and medical response teams for the athletes due to restricted access to athlete preparation and competition areas. The following section only deals with the Medical Services for Athletes, Coaches, visiting Physicians, Team Managers and Team Aqua. Medical Services for spectators, media, marketing partners, and workforce is described in Part One, Article 9.21.

Venue medical care should be implemented at the international standards of 'Good Clinical Practice'. For example, venue medical personnel should be competent in the latest *Advanced Trauma Life Support (ATLS)* and *Advanced Cardiac Life Support (ACLS)* guidelines. For the assessment and treatment of sports injuries, the *IOC Manual of Emergency Sports Medicine* may be used as a reference tool.



Determination of the requirements for venue medical services for each training and competition venue medical station and Field of Play medical station is contingent upon the sport-specific requirements. These requirements are developed following an analysis (Risk Assessment) of the following factors:

- Sport medical risk assessment
- Expected number of athlete participants
- Duration of event

The number and location of the Venue Medical Station may vary as per the size of the event and of the Venue. Sometimes there could be a main Venue Medical Station and a FoP Medical Station or Treatment Area.

Athlete medical services must be provided on all days of official training and competition, beginning at a minimum of one hour before training or competition begins.

#### **9.2.5.1 Venue Medical Station**

##### **9.2.5.1.1 Location**

The Medical Station is to be designated at each competitive venue (e.g. for the six sports venues in the case of the World Aquatics Championships). The area should be clearly identified and be within easy access from the FoP. Access to ambulance transport should also be easily reached from the treatment area.

##### **9.2.5.1.2 Size**

The Medical Treatment Area should be adequate in size to accommodate the expected volume of athletes and medical personnel as designated for the specific World Aquatics event.

For example, at the World Aquatics Championships, the facility should be large enough to examine and treat 3 – 4 athletes at any given time.

##### **9.2.5.1.3 Equipment & Staff**

The station should be at minimum staffed by a physician and nurse and may include other support staff.

In addition to the provision of medical care, staff duties will include documentation of care; operational and clinical reporting; management of equipment and supplies; communication; and base of operations for the venue's FoP medical teams.

Staffing numbers should support the volume of anticipated medical encounters based on review of previous World Aquatics Events.

The equipment and supply requirements should include at minimum:

- Basic and Advanced Life support equipment. BLS and ALS equipment should include defibrillators, strategically located for quick response
- Evacuation equipment for immobilization of the athlete, transport from the FoP, and transport from the venue
- Orthopaedic soft goods, splinting materials, bandaging, suture kits, etc. that may be required on-site so the athlete can be treated and allowed to return to competition, if clinically appropriate
- First aid supplies
- Ice
- Sealed nutritious beverages, water and snacks.

##### **9.2.5.1.4 Privacy**

Provision for adequate privacy to protect that athlete's right to confidential health care is important.

##### **9.2.5.1.5 Security & Access**

Access to the Medical Treatment Area should be limited to medical staff, athletes, coaches, visiting physicians, team managers and the World Aquatics Family. For privacy reasons, access to the media and the public should not be allowed.

##### **9.2.5.1.6 Health Care Personnel**

When possible, a secure lounge or lunch/relaxation area for healthcare professional should be organised.

##### **9.2.5.1.7 Pharmacy**





The OC Medical Team shall ensure secure storage for medications, including controlled drugs as per the law of the host country.

### 9.2.5.2 **Field of Play Treatment Area**

#### 9.2.5.2.1 **Location**

In regard to the location adjacent to the FoP, the following shall be taken into consideration:

- Ease of access to the FoP (i.e on the pool deck, next to the pontoon in Open Water)
- Ease of access to the venue medical station and/or emergency evacuation pathway
- Ability for the FoP healthcare professionals to clearly see the sport activity
- Location protected from media scrutiny as feasible.

#### 9.2.5.2.2 **Minimum Equipment**

- BLS and ALS equipment
- Evacuation equipment for immobilization of the athlete, transport from the FoP, and transport from the venue

### 9.2.5.3 **Physiotherapy and Massage Services**

With the occasion of the World Aquatics Events, the OC generally provides at free of charge physiotherapy and massages for the athletes.

Physiotherapists and masseurs will be allowed to perform massages on those athletes who do not have a medical team to support them.

The massages that are normally offered are:

- Warm-up
- Recovery
- Unload
- Manual therapy
- Stretches
- Osteopathic adjustments
- Functional bandaging
- Kinesis taping

The necessary physiotherapy equipment (e.g. laser, cryo-laser, ultrasound, etc.) will depend on the space allocated for that purpose in each venue.

Examples of treatment location :

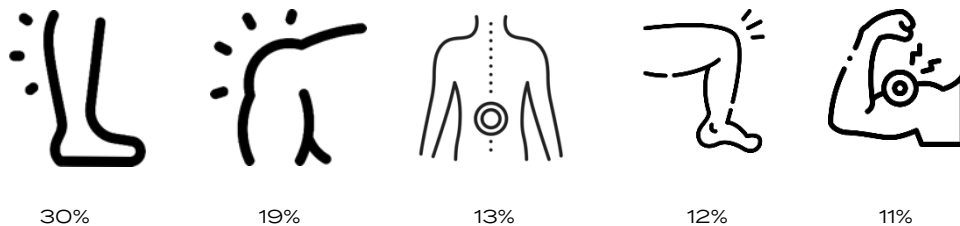

### 9.2.5.4 **Ice-baths**

For recovery, it is recommended to offer two (2) Ice baths (minimum width 0.8 m, length 1.2 m, depth 1.0 m) or 14° C water tubs. Alternatively, ice-machines shall be available to teams and athletes for their own tub, or to ice an injury.

## 9.2.6 **Emergency Action Plan and Medical Response Protocol**

### 9.2.6.1 **Emergency Action Plan**

The Emergency Action Plan should be clearly defined according to the sport-specific risk. It should include:

Procedures for how and when to access the FoP; and



Emergency treatment and evacuation procedures from the FoP:

- Include educational videos
- Daily medical scenario training/practice
- Emergency medical protocol for athlete medical stations

Clearly defined protocols for the FoP for dealing with:

- Cardiac arrest
- Life-threatening injury
- Death

The exit pathway from the FoP to either the athlete venue medical station or the ambulance

Location of ambulance transportation

Location of automatic external defibrillators

Completion of medical records, including the maintenance of confidentiality

Communication procedures (who, how and when) for communicating with the:

- Ambulance/emergency medical service
- Venue medical manager
- Designated hospital
- Members of the OC medical team
- SMC Chairperson
- Media

The diagram hereafter is an example of an Emergency Action Plan.

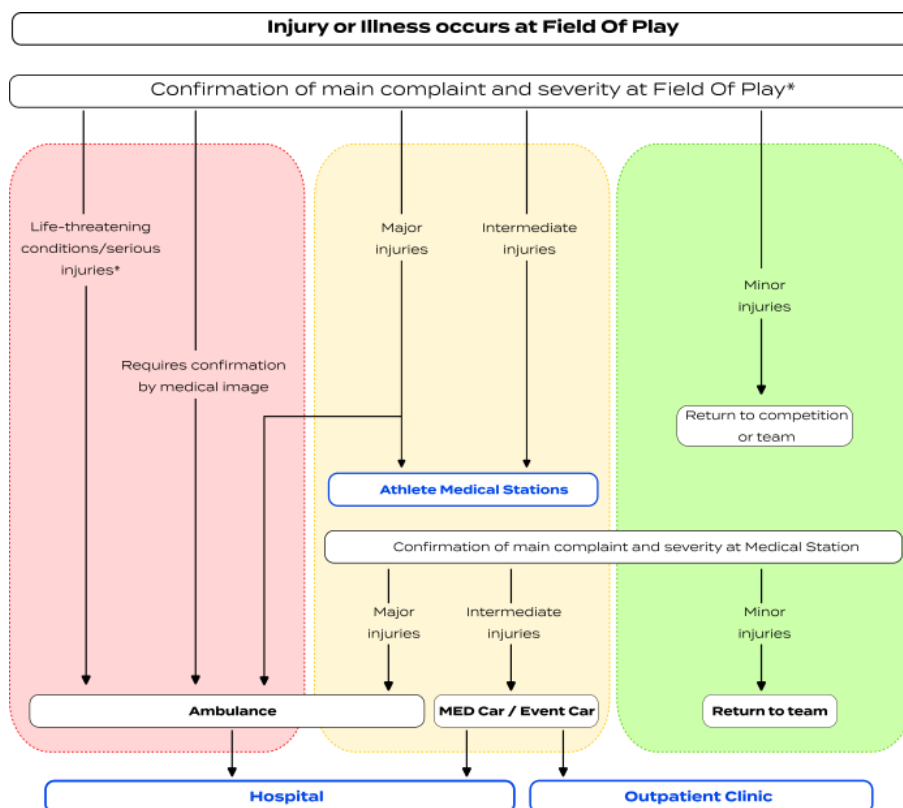

Source: ASOIF Health Care Guidelines for IFs, 2020

(\*initial life-saving interventions to occur immediately prior to transportation as applicable: e.g., emergency heat stroke should receive immediate intervention at the venue prior to transfer by ambulance)

**9.2.6.2 Medical Response Protocol**



Each event is different. When possible, a test event is recommended to evaluate the competition planning, including the medical response and patient evacuation. This must also include safety provisions at training sessions and warm-up.

Past medical experiences from previous events should be shared in advance with the OC Medical Team to assist in preparation.

Team physicians should also contact the CMO in advance with concerns for any athletes requiring special medical attention or specific treatment.

#### **9.2.6.2.1 Contact details**

Before the competition, the following contact persons must be clearly identified, and their contact details made available:

- OC Chief Medical Officer (CMO)
- OC Sport Manager
- World Aquatics Technical Delegate (TD)
- World Aquatics Medical Delegate (MD)
- World Aquatics Sport Manager
- World Aquatics Medical Manager
- Each participating Team Leader

#### **9.2.6.2.2 Water Rescue**

Clearly identified Lifeguards will be present at all competition and training sessions. They must be experienced in deep water rescue and familiar with water retrieval covering a range of potential medical incidents. Daily practice and rehearsal of athlete extraction is a requirement.

#### **9.2.6.2.3 Competition Medical Response**

A direct and permanent supervision of the FoP shall be maintained during the athlete's competition.

If the medical team is reduced due to evacuation of an injured athletes from the FoP to the Medical Treatment Area. A HCP from the warm-up pool could be called to temporary replace the medical staff dealing with the casualty.

A full complement of medical staff should always be maintained at the venue and different swimming pool.

#### **9.2.6.2.4 Preparation**

All medical planning should be undertaken well in advance of any scheduled event. During the event, (training and competition), the OC CMO or VMO must ensure the following:

- A trained, identifiable, and fully accredited Medical Team.
- A well-equipped, fully-staffed on-site medical room.
- A fully-operational communication system linking key personnel.
- A well-rehearsed athlete extraction protocol from the pool to the medical room.
- Adequate training for all emergency procedures.
- Attention to athlete dignity and confidentiality at all times.
- Availability of emergency transport to identified hospital services.

#### **9.2.6.2.5 The Medical Team Response**

The initial response depends on the nature of the injury or incident and whether it occurs in the water or on the ground/pool deck.

For any incident in a pool, and the athlete is conscious, he/she can hold onto a flotation device and be towed to the side with lifeguard support.

If unconscious, the athlete must be stabilized on a flotation device. At this point consider need for CPR and cervical stabilisation. A well-rehearsed extraction protocol of the unconscious or injured athlete from the water requires practised teamwork. A primary survey, conducted on the poolside, will identify life-threatening conditions warranting immediate intervention.



When stable, the athlete can be transported to the medical room for a more definitive assessment including potential for closed head injury. Here, the decision for hospital transfer, via ambulance, is made. At all times public and media attention should be managed judiciously and team support personnel must be alerted.

Clearly, the medical team response for a fully conscious, mobile athlete is modified accordingly. The primary assessment on the pool deck will determine the need for urgency and transfer to the medical room. Accompanying NF medical support, where present, may be engaged in this process. Their knowledge of the athlete may be of inestimable value to local medical staff. However, the NF team support should not interfere with the medical response. In all circumstances, the ultimate management plan for the athlete will derive from consultation between the CMO and NF team support staff as available. Consultation with the appropriate SMC Member is a courtesy and will not influence the management plan or decision to refer the athlete for hospital care.

### **9.2.7 Emergency Transport Plan**

The venue pathways to emergency transport to hospital for medical care that cannot be provided in the venue should be delineated to ensure adequate planning and preparation prior to the event.

*Assurance of appropriate accreditation access is required for all medical personnel to accompany the injured/ill athlete from the FoP or Venue Medical Station to the emergency transport location.*

Security and protocol personnel should be aware of the Emergency Transport Venue Pathway and compliant to allow access as required.

The Emergency Transport Plan should include:

- Number of ambulances:
  - Athlete ambulance(s)
  - Spectator ambulance(s)
  - Back-up/support ambulance(s)
- Minimum level of ambulance equipment
- Minimum skill level of ambulance crew (e.g., emergency medical transport/paramedic, ATLS, ACLS etc.)
- Location of ambulances
- Non-emergency medical transport:

In non-emergency situations, the process/means for transportation from the venue to either an outpatient clinic or designated event hospital should be identified (e.g., car, taxi, event transport)

Where the travel time by ambulance between the venue and the nearest hospital with emergency room facilities is longer than one (1) hour, then the safety plan shall require provision for helicopter transport.

#### **9.2.7.1 Sports Requirements**

##### **9.2.7.1.1 Swimming / Water Polo / Artistic Swimming**

It is recommended that the ambulance be located on site at the competitive venue during training and competitive sessions. If emergency response times can be guaranteed to within a few minutes than use of off-site ambulances is acceptable (option to be approved in advance by World Aquatics Sports Medicine Committee).

##### **9.2.7.1.2 Open Water Swimming**

A medical boat capable of medically stabilizing an athlete and providing emergency transport must be on the course throughout the competition with reserve available in the event of the original medical boat having to leave the competition site. In addition, a land-based ambulance must also be on site.

##### **9.2.7.1.3 Diving / High Diving**

An ambulance must be on-site throughout all training and competition periods. A reserve unit must be available in the advent of a transport by the first ambulance team. (if necessary for High Diving, a medical boat like for Open Water).

#### **9.2.8 Venue Pharmacy Formulary**

##### **9.2.8.1 General**



World Aquatics does not have specific requirements related to the medications for the Venue Medical Station and the Field of Play Treatment Area.

Systems for secure storage and medication management must be in place for the event according to the law of the host country.

A pharmacist may be appointed to set up and manage the pharmacy service provision for the event.

Controlled drugs (such as morphine for strong analgesia) may require special storage requirements and records to be kept, according to the laws of the host country.

All medications must be recorded for each patient.

### **9.2.8.2 Anti-Doping Requirements**

All OC Medical Personnel must be familiar with the substances and methods that are prohibited in sport ([WADA Prohibited List and Methods](#)).

The [WADA Therapeutic Use Exemption International Standard](#), along with World Aquatics-specific protocols for Therapeutic Use Exemption applications, should also be referenced:

All medications at the World Aquatics Events that are also on the WADA Prohibited List should be clearly marked (e.g. coloured stickers, etc.) for easy identification as a warning to prescribing clinicians for the need for a Therapeutic Use Exemption.

If a prohibited drug is required to be prescribed, both the prescribing physician and the athlete who is receiving the medication must sign the prescription form to confirm that they are both aware of the status of the substance and that the athlete consents to receiving the drug. The dispensing pharmacist should sign the prescription to verify that they have informed the physician and the athlete that the substance is prohibited. A duplicate copy should be given to the athlete in case of notification for doping control, so the athlete has a record in writing of recent medication intake and to aid in potential results management of an adverse analytical finding.

It is also recommended that all OC Medical Personnel (including the CMO) complete the *ADEL Medical Professional's Education Program* on [WADA's ADeL](#) (anti-doping e-learning platform).

### **9.2.9 Hospitals and Isolation Facilities**

#### **9.2.9.1 Hospitals**

Hospital allocation for the World Aquatics Events should take into consideration:

- Anticipated health concerns
- Available hospital services (e.g. major trauma/ medical preparedness as in major trauma centres)
- Proximity to venues
- Insurance/financial requirements

The designated hospital(s) shall be communicated to World Aquatics in advance.

A few months before the World Aquatics Event, the Chief Medical Officer should develop a plan for the referral and potential transport of injured and/or ill athletes. A link with a nearby medical facility/hospital capable of providing continuing emergency care, access to laboratory investigations, imaging, and specialist opinions, including dental, should be established.

#### **9.2.9.2 Isolation facilities in case of pandemic**

Experiences with the COVID-19 pandemic during World Aquatics Events demonstrate the need to anticipate an isolation facility(ies), which could include in-room services.

#### **9.2.10 Public Health Requirements**

For major events, adherence to local public health legislation and regulations is important. Contact should be made in advance to ensure appropriate planning. The key considerations for public health at World Aquatics Events are to:

- Reduce and manage the risk of individuals acquiring an infectious illness
- Encourage health-promoting behaviours in athletes, officials and visitors
- Food and water safety

**9.2.10.1 Prevention of infectious diseases**

The recent years have shown that organising mass gathering events could represent a public health challenge. The OC Medical Team shall consider about management policy for infectious/communicable diseases. This may include:

- Required immunisations for visiting athletes and World Aquatics Family and guests (e.g. COVID-19, Measles, etc.).
- Geographical risks of host location (Dengue, Malaria).
- Protocols for isolation of athletes/teams with communicable diseases (COVID-19 Protocol).
- Criteria for sport participation for ill and recovering athletes.
- Essential medications required for treatment of an infectious outbreak.
- Safe and secure food supply.
- The food supply channels may be at increased risk. The OC and Public health authorities should work with local law enforcement and security agencies to ensure the safety of the food supply at the venues (training/competition/staff catering) and at the accredited participants' accommodation (hotels/village).
- The safety includes food and water hygiene as well as protection against inadvertent ingestion of substances included on the WADA Prohibited List from contaminated foods or sports products.

**9.2.11 Environmental considerations****9.2.11.1 General**

The OC Medical Team should consider the Environmental issues and evaluate them based on historical records. A risk mitigation strategy may need to be developed to address environmental risks.

Environmental risks depend on the following factors at the geographic location of the event:

- Climate: heat/cold, other extreme weather conditions
- Elevation/altitude
- Air quality
- Water quality

The other factors to be considered by OC Medical Team and World Aquatics are the:

- Duration of the sport event
- Physiological requirements of the sport/discipline
- Time of day of the competition and training sessions
- Time of year of the event

**9.2.11.2 Water Quality**

Water quality is a fundamental element of our sports.

For water quality, the OC medical team should share with World Aquatics and NFs, the records and archives from previous years.

Should there be environmental risks, consultation with sport science environmental specialists is recommended and some strategies and corrective actions be implemented.

Specific information about Water Quality may be found in the sport-specific Part of these Regulations.

**9.2.11.2.1 Tap Water Quality**

OC shall indicate whether the tap water is drinkable without risk of infection.

**9.2.11.3 Risk Mitigation Strategy**

The Aquatic Sports Venues could be indoor or outdoor.

Sports like open water and high diving are conducted outdoors and exposed to weather conditions.

Therefore, before any event, the OC shall provide information on the actual environmental conditions and their expected evolution. It should help the NF to organise suitable travel and acclimation arrangements to their athletes.

**At the competition venue:**



- World Aquatics should consider the implementation of specific protocols: early departure, event cancellation, additional breaks for officials and athletes, appropriate clothing for officials, etc.
- OC should aim to minimise environmental exposure by adapting scheduling, providing cooled/warmed team tents and waiting areas, etc.
- OC should provide mitigation measures for spectators and officials (educate on behaviour to adopt, provide hydration and shade, and distribute goodies such as paper fans and caps if necessary).

**The LOC Medical Team should:**

- Organise appropriate training for the medical staff in recognition and emergency treatment protocols.
- Provide of specialist medical equipment such as ice baths for full body immersion.
- Give access to essential medication which reflect the environmental risks.
- Have clear algorithms displayed in the medical venue (e.g., exertional heat stroke algorithms).
- Planning for any specific medical equipment related to the environmental conditions (e.g. cooling bath, warm baths, rectal thermometer, sodium tester, etc.).

World Aquatics and OC should also have a communication strategy to deal with the environmental factors that may impact the organisation of a competition (race, match).

**9.2.12 Safety and security**

It is important for the OC medical team to have strategised with local safety and security departments for the event, safety and security as well as for disaster planning.

Details to be addressed include:

**Liaison with:**

- Police services in case of emergency to provide additional security.
- Fire department services in case of fire emergency.
- Emergency transportation services.
- Tertiary care health services.
- Supply source of essential medications.
- Blood banks.
- Emergency mental health services for psychological support as required.
- Public health services.

**Policies and procedures for major incidences/disasters:**

- Terrorist attacks.
- Environmental disasters such as earthquakes, tsunamis, fire, weathers, etc.
- Venues malfunction.

**9.2.13 Nutrition Requirements**

World Aquatics and OC medical teams should ensure adequate and appropriate nutrition at international sporting events. Nutritional requirements should include:

At the training and competition venues, provision of:

- Water and carbohydrate-electrolyte replacement ('sports drink') as applicable.
- A variety of food options to aid athlete recovery.

At athlete lodging, delivery of a catering plan that achieves:

- Sufficient menu variety within and between meals to manage food boredom and to provide ample choices for the needs of the athletes.
- Attention to the food culture of the athletic population including special cultural practices (e.g., halal, kosher)
- Food/menu options that meet the health and specific sports nutrition considerations of the athletic population (e.g., carbohydrate loading).
- Support for special dietary needs (e.g., food intolerances and allergies) or choices (e.g., vegan/vegetarian) of the athletes.
- Point of choice labelling of menu items to identify nutritional characteristics and other key information (e.g., presence or absence of allergens).
- (Ideally) provision of additional education resources around sports nutrition guidelines.



- Sufficient accessibility to support the overall nutritional needs of the athletes and the logistics around training and competition schedules, including flexibility to meet special needs.

Ideally, information about the catering plan should be provided ahead of the World Aquatics Event for distribution to the NFs to assist in their preparations and specific plans. Such information should include:

- Specific information on key issues that might arise around the specific competition or location (e.g., food and water hygiene, control of potential contamination of food supplies).
- Specific details of how special nutritional or cultural needs will be met, including key contacts to discuss/arrange additional needs.
- Specific information regarding the importing of additional food supplies to the location (e.g., local customs or quarantine regulations) to assist teams or individuals with plans to supplement the catering plan.
- Protocols and procedures for the management of any declared outbreak of food-related illness.

#### **9.2.13.1 Hotel Requirements and Flexible Serving Times**

Meal times must be flexible. For instance, the hotel must be able to serve breakfast before early morning practices and dinner after late evening competitions.

#### **9.2.14 Athlete Safeguarding (Harassment and Abuse) Requirements**

##### **9.2.14.1 Policies and Procedures**

The World Aquatics Athlete Safeguarding Policy can be found on Aquatics Integrity Unit' website:

<https://aquaticsinTEGRITY.com/>

Any issue shall be reported to the Aquatic Integrity Unit.

#### **9.2.15 Athlete Mental Health Support**

Evidence shows that athletes at the elite level have a higher prevalence of mental health symptoms and disorders than non-athletes.

As such, World Aquatics aims to ensure the provision of adequate and effective mental health support for athletes at World Aquatics Events.

Hence, the following considerations to address athlete mental health issues should be assessed by World Aquatics and/or OC:

- Opportune timing of competition events
- Appropriate timing of training/competition sessions to allow adequate recovery and sleep
- Provision of time for recovery post-training and competition
- Efficient transport system and close distance between venue and accommodation
- Allocation of quiet spaces of low stimulation
- If possible, inclusion of a licensed/registered mental health professional with experience in elite sport on the OC medical team
- Availability of a referral network of licensed/ registered mental health professionals.

#### **9.2.16 Host Country Government Regulations**

Host countries may have specific requirements relevant to the provision of athlete health care delivery that need to be considered in the planning and delivery of the health care program at World Aquatics Events. These regulations fall under three categories:

- Medical licensing of visiting medical physicians
- Drug and medical equipment importation
- Mass event policies and procedures

##### **9.2.16.1 Medical Licensing**

The OC shall outline the legal requirements for medical licensing of foreign physicians in the country of the event as required. Links to regulations on official government websites should be provided.

##### **9.2.16.2 Drug and Medical Equipment Importation**





The OC medical team shall publish the national legal requirements for drug and medical equipment importation in sufficient time in advance of the World Aquatics Events for the visiting NF medical personnel. Such guidance should cover the following scenarios:

- Importation of medication supplies by team physicians for team use
- Importation of personal medication by individual athletes
- Importation of controlled drugs
- Importation of medical equipment
- Provision of medical care offered to an athlete (e.g., use of opiates in a pre-hospital environment).

#### **9.2.17 After-hours Medical Care**

After-hours emergency medical care for the athletes, visiting team officials, judges, referees and the World Aquatics Family should be arranged with easy access through the official Event hotels. This includes:

- After hours (out of venue) urgent care
- Medical services at hotels
- Athlete village health services (if applicable)

Processes and contact details should be provided with the Team Leader information packs.

##### **9.2.17.1 Language Services**

The OC should provide adequate and timely language services to facilitate the delivery of medical care at the training and competition venues. This should include:

- Contact information for access to the event language translation services
- Designation of medical translation services (if applicable)
- Languages included
- A statement about medical information confidentiality when using language services.

##### **9.2.17.2 Glasses/Lenses Services**

This is not a World Aquatics requirement, but the experience shows that during our Events it may happen that some participants lose or break their glasses or lenses. When you have 5'000 accredited participants, it becomes a significant number of persons.

It would be appreciated if the OC could find few reliable partners/shops that will be able to respond to any urgent situation and to replace within few hours to few days the glasses or lenses.

Such a service will be at the participant's cost.

#### **9.2.18 Insurance & Liability**

##### **9.2.18.1 Insurance**

Each accredited participant shall have their own personal medical insurance.

Athletes, Officials and World Aquatics Family members are covered by World Aquatics Insurance which can be utilised to support healthcare provision as required. However, as World Aquatics Insurance does not cover all the situations, a personal insurance is necessary.

The OC has the responsibility to provide at a minimum **first aid medical care** during training and competitions. The World Aquatics Insurance may take the relay as soon as a participant is transferred to a hospital.

##### **9.2.18.2 Medical Personnel Malpractice Insurance & Liability**

World Aquatics and OC assume no responsibility for any healthcare provided by NF healthcare personnel to NF team members and delegates.

The OC should ensure that all members of the Medical Team are covered by professional liability insurance. The amount of coverage must be commensurate with the risks associated with providing the Medical Programme as described herein.

It is recommended that NF healthcare professionals inform their insurance company that they are travelling abroad with a sports team, and check whether their professional liability insurance covers this activity. Each NF should make its own arrangements for professional liability insurance.

#### **9.2.19 Non-smoking Policy**



The entire Venue is strictly non-smoking.

Appropriate signage shall be in place around the venues.

#### **9.2.20 Medical Communication Strategy**

World Aquatics Communication Policies regarding communication about health-related information should be reviewed in cooperation with the OC and the OC Medical Team.

Any question from the Media related to medical issues shall be addressed to the World Aquatics Communication Department. The Medical Team shall not communicate directly with the Media.

#### **9.2.21 Media, Marketing Partners, Workforce & Spectators Medical Services**

The OC shall make provisions for the health care of spectators, media, marketing partners, and workforce that are distinct from athlete health care.

The spectators, media, marketing partners, and workforce should include:

Designation of Health Care Personnel that are completely different from the athlete medical personnel

Allocation of a venue medical station for spectators, media, marketing partners, and workforce

Delineation of a medical action plan outlining:

- Location of automatic external defibrillators
- Removal from the spectator area
- Triage procedures
- Medical protocols for trauma and illness
- Transfer procedures from spectator venue medical station to ambulance
- Ambulance designation
- Hospital designation
- Spectator medical briefing
- Scenario training

Communication network

Medical record system

Public health requirements:

Environmental planning and protocols

Major incident planning and training

Provision of medical care for VIPs (if applicable)

#### **9.2.22 Medical Ethical Guidelines**

Athletes have the right to high-quality, ethical medical care. In elite sporting events, there may be external pressures or influences on athlete health care and return to sport from media, agents, coaches, NF presidents etc. who wish to sway an athlete's decision to participate.

As such, it is important to emphasise the principles of ethical, athlete-centred health care delivery to all members of the OC's medical team at World Aquatics Events.

This includes the athlete's right to:

- Confidentiality of health information
- Informed consent
- A second medical opinion
- The latest evidence-based medical care
- Safe and ethical medical practices

## **10 FACILITIES**

### **10.1 General**



The present Section related to Facilities is intended to provide the best possible environment for competitive use and training. This section does not intend to govern issues related to the general public. It is the responsibility of the owner or controller of a facility to provide supervision for activities undertaken by the general public.

**10.2 Pools****10.2.1 World Aquatics Olympic Standard Pools**

All World Championships (except the Masters World Championships) and Olympic Games must be held in pools that comply with the Facility Rules of each Sport (see Parts Two to Seven of these Competition Regulations).

**10.2.2 World Aquatics General Standard Pools**

Other World Aquatics events should be held in World Aquatics Olympic Standard Pools, but the Bureau may waive certain standards for existing pools if they do not materially interfere with the competitions.

**10.2.3 World Aquatics Minimum Standard Pools**

All other events held under World Aquatics Rules should be conducted in pools that comply with all of the minimum standards contained within this section.

**10.3 Automatic Officiating Equipment**

At the Olympic Games and World Aquatics Championships, the approved Automatic Officiating Equipment, including Video Judging Equipment shall be provided and used. The approved Video Judging Equipment shall be used to initiate stroke infraction calls, confirm stroke infraction calls or assist the Referee in overturning calls made on the pool deck.

**10.4 Availability of Venues**

For the World Aquatics Championships, all venues shall be available for use at least five (5) days before the opening ceremony.

For all other World Aquatics events all pools shall be available for use by entered competitors before the competition begins. Swimming, Open Water Swimming, Water Polo, Artistic Swimming - five (5) days prior, Diving, High Diving - eight (8) days prior.

**10.4.1 Training**

During the competition days, the pools shall be available for training when competitions are not in progress.

**10.5 Seating**

Seating positions along the side of the pool shall be provided for all competitors, team officials and unassigned technical officials, from which they may properly observe training and competitions.

**10.6 New competition equipment**

New competition equipment (e.g. Starting blocks, lane-ropes, etc.) must be available by 1st January in the year of the Olympic Games and World Aquatics Championships.

**10.7 Mechanical or technical malfunction**

At the Olympic Games, World Aquatics Championships, World Aquatics Swimming Championships (25m) and World Aquatics Junior Swimming Championships, it shall be the responsibility of the Chairperson of the World Aquatics Technical Swimming Committee (or his/her designee) to determine if a Competitor may receive an additional opportunity to compete in the situation when there is a mechanical or technical malfunction that affects the Competitor.

*Example: if the lane-line on either side of a competitor snaps during the first 20m of a 100m race, the Technical Swimming Committee Chairperson may grant the allowance to re-swim the race.*

At all other competitions, in the event of an equipment malfunction during a swimming race, the Referee may offer all competitors affected by such malfunction the opportunity to compete again.

**10.8** In order to protect the health and safety of persons using swimming facilities for the purposes of recreation, training and competition, owners of public pools or pools restricted only to training and competition must comply with the requirements established by law and the health authorities in the country where the pool is situated.



## 11 TECHNICAL OFFICIALS

### 11.1 General

The Judges nominated must be of the same nationality as the World Aquatics Member proposing them and fully certified by the respective Technical Committee. A naturalised Judge would be eligible to represent the World Aquatics Member that proposed him/her, if he/she will have lived in the territory of that Member for at least one year prior to that competition. A three- year transition period is required between the international representation of two different Members.

The World Aquatics Technical Committees will propose Technical Officials (Judges and Referees) to act at the Olympic Games or World Championships from the current World Aquatics Officials Lists in the respective sport, for approval by the World Aquatics Bureau or World Aquatics Executive.

For no show of nominated Officials, the respective Federation will be fined 2'000 Swiss Francs.

### 11.2 Age

The maximum age of Technical Officials when officiating at World Aquatics Championships or World Aquatics Competitions, except Masters, High Diving and Water Polo, shall be sixty-five (65) years when application is made for the respective World Aquatics List.

For High Diving the age limit shall be seventy-five (75).

For Water Polo, the age limit shall be sixty (60) years during the year of competition.

### 11.3 Technical Lists

Technical Officials must be on current World Aquatics Lists approved by the respective Technical Committee for the Aquatics sport in order to officiate at Olympic Games, World Aquatics Championships or World Aquatics Competitions. Nominated officials must be members of the nominating Federation and certified by the Member Federation in submitting their nomination.

## 12 SCORES, MEDALS AND TROPHIES

### 12.1 Scores and awards at the World Aquatics Championships & World Aquatics World Swimming Championships (25m)

In all World Aquatics Championships, points and awards are distributed as follows:

#### 12.1.1 Swimming

##### 12.1.1.1 Medals

Gold, Silver, and Bronze medals shall be awarded to the first three places in individual and relay final competitions. In swimming relays when preliminaries are swum, medals shall be awarded to those swimmers who have participated in the heats and/or the final.

In Swimming, in case of equal times, medals shall be awarded as follows:

1st place: 2 Gold – no Silver, 1 Bronze

2nd place: 1 Gold, 2 Silver – no Bronze

3rd place: 1 Gold, 1 Silver, 2 Bronze

In case of 3 equal times medals shall be awarded as follows:

1st place: 3 Gold – no Silver, no Bronze

2nd place: 1 Gold, 3 Silver – no Bronze

3rd place: 1 Gold, 1 Silver, 3 Bronze

##### 12.1.1.2 Diplomas



Using 8 lanes in Swimming, diplomas shall be awarded to all eight finalists in individual events and to the top eight finalists in relay competitions.

In swimming relays when preliminaries are swum, diplomas shall be awarded to those swimmers who have participated in the heats and/or the final.

### **12.1.1.3 Trophies**

#### **12.1.1.3.1 Team Trophy**

World Aquatics Team Trophy for the top-scoring team based on the following points:

Individual using 8 lanes:

Places 1 – 16:

18, 16, 15, 14, 13, 12, 11, 10, 8, 7, 6, 5, 4, 3, 2, 1 points

Relays using 8 lanes:

Places 1 – 8:

36, 32, 30, 28, 26, 24, 22, 20 points.

#### **12.1.1.3.2 Individual Trophies**

World Aquatics Individual Trophies for the top scoring male and female based upon the following points:

<b>First Place</b>	5 points
<b>Second Place</b>	3 points
<b>Third Place</b>	2 points
<b>Fourth Place</b>	1 point
<b>Individual World Record</b>	2 points for each record broken

If there is a tie, the World Aquatics Points Table shall be used, and a decision made by the World Aquatics.

### **12.1.2 Open Water Swimming**

#### **12.1.2.1 Medals**

Gold, Silver, and Bronze medals shall be awarded to the first three places in each individual and team events.

In Open Water Swimming, in case of equal places, medals shall be awarded as follows:

1st place: 2 Gold – no Silver, 1 Bronze

2nd place: 1 Gold, 2 Silver – no Bronze

3rd place: 1 Gold, 1 Silver, 2 Bronze

In case of 3 equal places medals shall be awarded as follows:

1st place: 3 Gold – no Silver, no Bronze

2nd place: 1 Gold, 3 Silver – no Bronze

3rd place: 1 Gold, 1 Silver, 3 Bronze

#### **12.1.2.2 Diplomas**

Diplomas shall be awarded to all eight finalists in each individual events and to the first eight finalists in team events.

#### **12.1.2.3 Trophy**

A special Team Trophy shall be given based upon the following points added from the 5 km, 10 km, 3km Knockout Sprint, and mixed team events. Double points shall be awarded for the mixed team event.

18 (1st place), 16, 14, 12, 10, 8, 6, 5, 4, 3, 2, 1 points

### **12.1.3 Diving**

#### **12.1.3.1 Medals**



Gold, Silver, and Bronze medals shall be awarded to the first three places in individual, synchronised and team events.

**12.1.3.2 Diplomas**

Diplomas shall be awarded to all eight finalists in each individual events and to the first six finalists in each synchronised and team events.

**12.1.3.3 Trophies**

A Team Trophy shall be given to the top scoring team based on the following points:

Individual diving events:

18-16-14-12-10-8-6-5-4-3-2-1 points

Synchronised diving events (12 finalists):

27-24-21-18-15-12-9-7,5-6-4,5-3-1,5 points.

Team Event

27-24-21-18-15-12-9-7,5-6-4,5-3-1,5 points

**12.1.4 High Diving****12.1.4.1 Medals**

Gold, Silver, and Bronze medals shall be awarded to the first three ranked Competitors in each event.

**12.1.4.2 Diplomas**

Diplomas shall be awarded to first eight finalists in each event.

**12.1.5 Water Polo****12.1.5.1 Medals**

Gold, Silver, and Bronze medals shall be awarded to all the players of the first three teams.

**12.1.5.2 Diplomas**

Diplomas shall be awarded to all the players of the first six teams.

**12.1.5.3 Trophies**

A trophy shall be given to the best scorer (men and women) and goalkeeper (men and women) of the championships.

**12.1.6 Artistic Swimming****12.1.6.1 Medals**

Gold, Silver, and Bronze medals shall be awarded to first three Competitors or teams in each individual, solo, duet, mixed duet and team events.

**12.1.6.2 Diplomas**

Diplomas shall be awarded to the first eight finalists in solo and duet events and to the first six finalists in team events.

**12.1.6.3 Trophy**

A Team Trophy shall be given to the best team of the championships based on the following points:

Solo, Technical Routine:

12, 11, 10, 9, 8, 7, 6, 5, 4, 3, 2, 1 points

Solo, Free Routine:

12, 11, 10, 9, 8, 7, 6, 5, 4, 3, 2, 1 points

Duet, Technical Routine:



18, 17, 16, 15, 14, 13, 12, 11, 10, 9, 8, 7 points

Duet, Free Routine:

18, 17, 16, 15, 14, 13, 12, 11, 10, 9, 8, 7 points

Mixed Duet Technical Routine

18, 17, 16, 15, 14, 13, 12, 11, 10, 9, 8, 7 points

Mixed Duet Free Routine

18, 17, 16, 15, 14, 13, 12, 11, 10, 9, 8, 7 points

Team Technical Routine:

24, 22, 20, 18, 16, 14, 12, 10, 8, 6, 4, 2 points

Team Free Routine:

24, 22, 20, 18, 16, 14, 12, 10, 8, 6, 4, 2 points

Free Combination:

24, 22, 20, 18, 16, 14, 12, 10, 8, 6, 4, 2 points

Acrobatic Routine:

24, 22, 20, 18, 16, 14, 12, 10, 8, 6, 4, 2 points

**12.1.7** In case of a tie, the highest points shall be awarded to each competitor or relay team.

**12.1.8 Commemorative Medals:**

Commemorative medals may be given to all those connected officially with the World Aquatics Championships.

**12.2 World Aquatics Junior Swimming Championships**

Points and awards at the World Aquatics Junior Swimming Championships shall be distributed as per Part One, Article 12.1.1.

**12.3 World Aquatics Junior Open Water Swimming Championships**

**12.3.1 Awards**

**12.3.1.1 Medals**

Gold, Silver, and Bronze medals shall be awarded to the first three places in each individual and team events. Where equal places occur the award of medals shall be as described in Part One, Article 12.1.2.1.

**12.3.1.2 Trophy**

A special Team Trophy shall be given based upon the following points added from the four individual events (3km Knockout Sprint, 5, 7.5 and 10km) and mixed team events. Double points shall be awarded for the mixed-team event.

18 (1st place), 16, 14, 12, 10, 8, 6, 5, 4, 3, 2, 1 points

**12.4 World Aquatics Junior Artistic Swimming Championships**

Gold, Silver, and Bronze medals shall be awarded to first three Competitors or teams in each individual, solo, duet, mixed duet and team events.

The Junior World over-all Championship Title will be awarded to the Member Federation with the over-all highest raw score determined by combining results for all events.

**13 APPEALS**

**13.1 Appeal Procedure**

**13.1.1** An appeal must be submitted on the official World Aquatics appeal form ("Appeal Form"), which can be found on the World Aquatics website and in venue.



The Appeal Form must be submitted in accordance with the following timelines:

- **Swimming:** within thirty (30) minutes of the respective race's completion.
- **Open Water Swimming:** within thirty (30) minutes of the respective race's completion.
- **Diving and High Diving:** an oral complaint may be made by the Athlete, or on behalf of the Athlete by a team official, to a referee, immediately after the execution of a dive, a round of dives, or a section of the competition. If the complaint is not accepted by the referee, the formal appeal must be submitted on the Appeal Form within thirty (30) minutes of the session's completion.
- **Artistic Swimming:** within thirty (30) minutes of the session's completion.

**13.1.2** The appeal must be submitted to the designated World Aquatics representative ("World Aquatics Representative"), who shall be identified at the beginning of the applicable competition. The appeal shall only be considered complete if it is accompanied by a deposit of five hundred (500) United States dollars (or an equivalent amount in the applicable local currency).

**13.1.3** The World Aquatics Representative will present the appeal to the Chair of the Jury of Appeal, who will review the appeal and determine its validity. The Chair shall determine the validity as soon as reasonably possible following the appeal's submission.

**13.1.4** If the Chair deems the appeal to be invalid, pursuant to the criteria in section 14, the deposit shall be forfeited. If the appeal is deemed to be valid, the Chair shall initiate a review by the Jury of Appeal which shall render a final decision on the appeal as soon as reasonably practical. The Chair's decision regarding validity is final.

**13.1.5** If the Jury rules in favour of the appealing party, the deposit shall be returned to the appealing party, and the ensuing course of action shall be decided on a case-by-case basis.

**13.1.6** If the Jury rules against the appealing party, the deposit shall be forfeited.

**13.2 Jury of Appeal:**

**13.2.1** The Jury of Appeal shall be comprised of three members. One of the three members shall be the designated Chair. The three members shall be assigned by the World Aquatics President or Executive Director.

**13.2.2** Jury members shall be void of conflicts of interest in advance of their appointment. Jury members have an obligation to declare any possible conflicts of interest that may arise, for which the World Aquatics Executive Director shall determine whether a conflict exists.

The World Aquatics Bureau shall also designate a fourth individual who will act as a standby Jury of Appeal member in the event that a selected Jury member must recuse himself/herself due to a conflict of interest (including, but not limited to, having business relations with or the same nationality as an appealing party).

**13.2.3** The Jury of Appeal may consult video footage, documents and witnesses when making its decision, and may additionally choose to consult any other potentially impacted party, in person or in writing.

**13.2.4** Decisions of referees shall be afforded a significant degree of deference. The Jury of Appeal shall not substitute its view of the appealed matter for that of the referee unless the appellant presents clear evidence that the referee's decision was made arbitrarily, irrationally, or in abuse of the discretion afforded to the referee.

**13.2.5** Each member shall have one vote and the majority vote shall prevail.

**13.2.6** The decision of the Jury is final.

**13.2.7** Any allegations of eligibility violations are not subject this Appeal Procedure and shall be handled by the Aquatics Integrity Unit.

**13.2.8** There will be no Appeal Procedure for the sport of Water Polo.





## **14 MATTERS THAT CAN BE APPEALED**

**14.1** The following can be appealed in Swimming:

- Any decision of a referee as to the consequence of an Athlete's rule infraction.

**14.2** The following can be appealed in Open Water Swimming:

- Any decision, or lack thereof, of a referee that affects the outcome of the results (including, but not limited to, an Athlete's receipt of a yellow card or a disqualification).

**14.3** The following can be appealed in Diving and High Diving

- A referee's perceived failure to observe the appropriate rules and regulations of the competition.
- Any decision affected by unforeseen or dangerous conditions that are likely to have impacted the competitor (including, but not limited to, weather conditions, sudden and drastic noise increases and blinding camera flashes).

**14.4** The following can be appealed in Artistic Swimming:

- A referee's perceived failure to observe the appropriate rules and regulations of the competition.
- Any decision affected by unforeseen or dangerous conditions that are likely to have impacted the competitor (including, but not limited to, weather conditions, sudden and drastic noise increases and blinding camera flashes).

**14.5** This Appeal Procedure does not apply to the sport of Water Polo.

- In the event a Water Polo Coach wishes to make a challenge during a match, he or she may follow the protocol as detailed in Part 6, Appendix 10 of these Competition Regulations.

## **15 MUSIC REQUIREMENTS**

**15.1** **Clearance of Rights for Competition Music:** All music used by the competing Federations must be licensed prior to the start of each competition. World Aquatics will not be held responsible or liable in respect of any lawsuits related to copyright infringement for athletes' use of music to accompany their routines. All expenses, damages and/or costs related to such procedures will be the responsibility of each competitor and their respective Federation.

**15.2** The Host Federation shall ensure that all music used for Sport Presentation and entertainment purposes is fully licensed for such use prior to the start of each competition.



WORLD  
AQUATICS

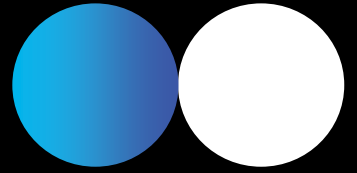

# SWIMMING

COMPETITION  
REGULATIONS

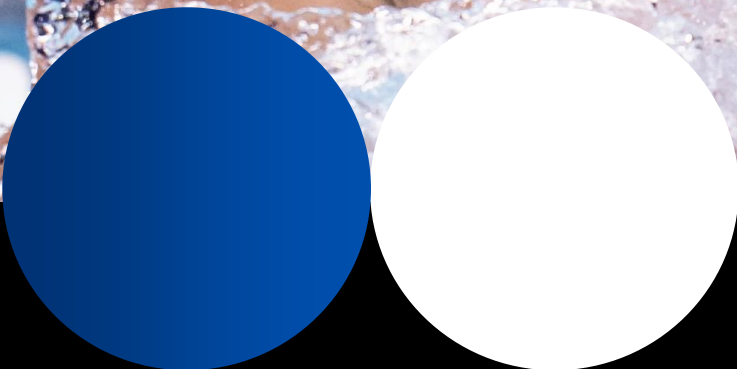



## TABLE OF CONTENTS

### PART TWO: SWIMMING RULES

<b>PART TWO: SWIMMING RULES</b> .....	<b>68</b>
<b>1</b> MANAGEMENT OF COMPETITIONS .....	<b>68</b>
<b>2</b> OFFICIALS .....	<b>70</b>
<b>3</b> SEEDING OF HEATS, SEMI-FINALS AND FINALS .....	<b>73</b>
<b>4</b> THE START .....	<b>75</b>
<b>5</b> FREESTYLE .....	<b>75</b>
<b>6</b> BACKSTROKE .....	<b>75</b>
<b>7</b> BREASTSTROKE .....	<b>76</b>
<b>8</b> BUTTERFLY .....	<b>76</b>
<b>9</b> MEDLEY SWIMMING .....	<b>77</b>
<b>10</b> THE RACE .....	<b>77</b>
<b>11</b> TIMING .....	<b>78</b>
<b>12</b> WORLD RECORDS .....	<b>78</b>
<b>13</b> AUTOMATIC OFFICIATING PROCEDURE .....	<b>80</b>
<b>14</b> AGE GROUP RULES – SWIMMING .....	<b>81</b>
<b>15</b> SWIMWEAR AND WEARABLES .....	<b>81</b>
<b>16</b> SWIMMING FACILITIES AND EQUIPMENT .....	<b>81</b>
<b>17</b> MEDICAL AND SAFETY SPECIFIC REQUIREMENTS FOR SWIMMING .....	<b>94</b>
<b>18</b> APPENDICES .....	<b>95</b>
18.1 APPENDIX 1 - DIAGRAM SWIMMING POOL 50x25m – 8 Lane .....	96
18.2 APPENDIX 2 - DIAGRAM SWIMMING POOL 50X25m – 10 Lanes .....	97
18.3 APPENDIX 3 - DIAGRAM SWIMMING POOL 50X25m – 10 Lanes .....	98
18.4 APPENDIX 4 - DIAGRAM SWIMMING POOL 50X25 WITH ONE BULKHEAD IN LATERAL POSITION .....	99
18.5 APPENDIX 5 - DIAGRAM SWIMMING POOL 50X25M WITH ONE BULKHEAD –BULKHEAD IN CENTRAL POSITION .....	100
18.6 APPENDIX 6 - DIAGRAM SWIMMING POOL 25X21M – 8 Lanes .....	101
18.7 APPENDIX 7 - DIAGRAM SWIMMING POOL 25X21M – 8 Lanes .....	102
18.8 APPENDIX 8 - DIAGRAM SWIMMING POOL 25X25M – 10 Lanes .....	103
18.9 APPENDIX 9 - DIAGRAM SWIMMING POOL 25X26M – 10 Lanes .....	104
18.10 APPENDIX 10 - DIAGRAM 50m SWIMMING POOL – Lane markings .....	105



## PART TWO: SWIMMING RULES

### 1 MANAGEMENT OF COMPETITIONS

- 1.1** The Management Committee appointed by the governing body shall have jurisdiction over all matters not assigned by the rules to the referee, judges or other officials and shall have power to postpone events and give directions consistent with rules adopted for conducting any event.
- 1.2** Organisers of swimming competitions shall appoint sufficient officials to ensure the fairness, integrity and safety of the competition.
- 1.2.1** At the Olympic Games, the World Aquatics Championships, and the World Aquatics Swimming Championships (25m), the following minimum number of officials for the control of the competition shall be appointed:
- Referee (2)
  - Starters (2)
  - Judges of Stroke (4)
  - Chief Inspector of Turns (2)
  - Inspectors of Turns (16/20 + 2 reserves)
  - Control Room Supervisor (1)
  - Video Review Supervisor (1)
  - Video Review Judges (4/5)
  - Call Room Supervisor (1)
  - Call room judges (4/5)
  - Resolution Desk judge
  - Warm-up supervisor(s)
- 1.2.2** For all other international competitions, the governing body shall appoint the same or fewer number of officials, subject to the approval of the respective regional or international authority where appropriate.
- 1.2.3** Where Automatic Officiating Equipment is not available, such equipment must be replaced by a chief timekeeper. Wherever possible, a minimum of one (1) timekeeper per lane shall be appointed together with one (1) additional timekeeper in case of a watch malfunction. It is advisable that there shall be three (3) timekeepers for each lane.
- 1.2.4** Finish Judges may be used when Automatic Equipment and/or watches are not used.
- 1.3** The swimming pool and the technical equipment for the Olympic Games and World Aquatics Championships shall be inspected and approved prior to the Swimming competitions by the World Aquatics Delegate together with a member of the Technical Swimming Committee.
- 1.4** Where underwater video equipment is used by television, the equipment must be operated by remote control and shall not obstruct the vision or path of swimmers and must not change the configuration of the pool or obscure the required World Aquatics markings.
- 1.5** The event management shall specify for heats, semi-finals, and finals the presentation and preparation protocol that the competitors must respect when they leave the final call-room.
- 1.6** **Program of World Aquatics and Olympic Games Swimming Competitions**
- The events and competition programme for each World Championships, including the World Aquatics Swimming Championships 25m will be agreed in advance by World Aquatics.

**1.6.1 Program of the Olympic Games**

	<b>Men</b>	<b>Women</b>
<b>Freestyle</b>	50m, 100m, 200m	50m, 100m, 200m
	400m, 800m, 1500m	400m, 800m, 1500m
<b>Backstroke</b>	100m, 200m	100m, 200m
<b>Breaststroke</b>	100m, 200m	100m, 200m
<b>Butterfly</b>	100m, 200m	100m, 200m
<b>Individual Medley</b>	200m, 400m	200m, 400m
<b>Relays: Freestyle</b>	4x100m, 4x200m	4x100m, 4x200m
<b>Relays: Medley</b>	4x100m	4x100m
<b>Mixed Relays</b>	4x100m Medley	

Only entry times achieved in 50m pools will be accepted. Heats and semi-finals may be swum using 10 lanes. Finals should be swum using 8 lanes.

**1.6.2 Program of the World Aquatics Championships (50m)**

	<b>Men</b>	<b>Women</b>
<b>Freestyle</b>	50m, 100m, 200m	50m, 100m, 200m
	400m, 800m, 1500m	400m, 800m, 1500m
<b>Backstroke</b>	50m, 100m, 200m	50m, 100m, 200m
<b>Breaststroke</b>	50m, 100m, 200m	50m, 100m, 200m
<b>Butterfly</b>	50m, 100m, 200m	50m, 100m, 200m
<b>Individual Medley</b>	200m, 400m	200m, 400m
<b>Relays: Freestyle</b>	4x100m, 4x200m	4x100m, 4x200m
<b>Relays: Medley</b>	4x100m	4x100m
<b>Mixed Relays</b>	4x100m Freestyle and 4x100m Medley	

Only entry times achieved in 50m pools will be accepted. Heats and semi-finals may be swum using 10 lanes. Finals should be swum using 8 lanes.

**1.6.3 Program of World Aquatics Swimming Championships (25m)**

	<b>Men</b>	<b>Women</b>
<b>Freestyle</b>	50m, 100m, 200m	50m, 100m, 200m
	400m, 800m, 1500m	400m, 800m, 1500m
<b>Backstroke</b>	50m, 100m, 200m	50m, 100m, 200m
<b>Breaststroke</b>	50m, 100m, 200m	50m, 100m, 200m
<b>Butterfly</b>	50m, 100m, 200m	50m, 100m, 200m
<b>Individual Medley</b>	100m, 200m, 400m	100m, 200m, 400m
<b>Relays: Freestyle</b>	4x50m, 4x100m	4x50m, 4x100m
	4x200m	4x200m
<b>Relays: Medley</b>	4x50m, 4x100m	4x50m, 4x100m
<b>Mixed Relays</b>	4x50m Freestyle and 4x50m Medley	



Entry times achieved in 25m and 50m pools will be accepted. Heats and semi-finals may be swum using 10 lanes. Finals should be swum using 8 lanes.

#### 1.6.4 Program of the World Aquatics Junior Swimming Championships

	Men	Women
<b>Freestyle</b>	50m, 100m, 200m	50m, 100m, 200m
	400m, 800m, 1500m	400m, 800m, 1500m
<b>Backstroke</b>	50m, 100m, 200m	50m, 100m, 200m
<b>Breaststroke</b>	50m, 100m, 200m	50m, 100m, 200m
<b>Butterfly</b>	50m, 100m, 200m	50m, 100m, 200m
<b>Individual Medley</b>	200m, 400m	200m, 400m
<b>Relays: Freestyle</b>	4x100m, 4x200m	4x100m, 4x200m
<b>Relays: Medley</b>	4x100m	4x100m
<b>Mixed Relays</b>	4x100m Freestyle and 4x100m Medley	

Only entry times achieved in 50m pools will be accepted. Heats and semi-finals may be swum using 10 lanes. Finals should be swum using 8 lanes.

#### 1.6.5 Program of the World Aquatics Swimming World Cup

The program of the World Aquatics Swimming World Cup will be defined by World Aquatics on an annual basis.

## 2 OFFICIALS

### 2.1 Referee

- 2.1.1** The Referee shall have full control and authority over all officials, approve their assignments, and instruct them regarding all special features or regulations related to the competitions. She/He shall enforce all rules and decisions of World Aquatics and shall decide all questions relating to the actual conduct of the meet, and event or the competition, the final settlement of which is not otherwise covered by the rules.
- 2.1.2** The Referee may intervene in the competition at any stage to ensure that the World Aquatics regulations are observed, and shall adjudicate all protests related to the competition in progress.
- 2.1.3** When using Finish Judges without three (3) digital watches, the Referee shall determine placing where necessary. Automatic Officiating Equipment, if available and operating shall be consulted as stated in Part Two, Article 13.
- 2.1.4** The Referee shall ensure that all necessary Officials are in their respective posts for the conduct of the competition. He/She may appoint substitutes for any who are absent, incapable of acting or found to be inefficient. He/She may appoint additional officials if considered necessary.
- 2.1.5** Once all swimmers have removed their clothing, except for swimwear, the Referee shall signal the commencement of an event by a short series of whistles inviting them to get ready at the starting end, followed by a long whistle indicating that they should take their positions on the starting platform (or for backstroke swimming and medley relays to immediately enter the water). A second long whistle shall bring the backstroke and medley relay swimmer immediately to the starting position. When the swimmers and officials are prepared for the start, the referee shall gesture to the starter with a stretched-out arm, indicating that the swimmers are under the starter's control. The stretched-out arm shall stay in that position until the start is given.
- 2.1.6** A disqualification for initiating the start before the starting signal must be observed and confirmed by both the Starter and the Referee. When Automatic Officiating Equipment is available, it may be used to verify the disqualification.



**2.1.7** The Referee shall disqualify any swimmer for any other violation of the rules that they personally observe. The Referee may also disqualify any swimmer for any violation reported to him by other authorised Officials. All disqualifications are subject to the decision of the Referee.

**2.1.8** All potential infractions shall be verbally reported to the Referee. Once confirmed by the Referee, a signed disqualification card shall be completed by the reporting Official, detailing the event, lane number and the infraction.

**2.1.9** The Referee shall appoint Officials who shall determine, in relay events, whether the starting swimmer is in contact with the starting platform when the preceding swimmer touches the starting wall. When Automatic Officiating Equipment which Judges relay take-offs is available, it shall be used in accordance with Part Two, Article 13.1.

## **2.2 Control Room Supervisor**

**2.2.1** The Control Room Supervisor shall supervise the operation of the Automatic Officiating Equipment.

**2.2.2** The Control Room Supervisor is responsible for checking the results from computer printouts.

**2.2.3** The Control Room Supervisor is responsible for checking the relay exchange printout and reporting any early take-offs to the referee.

**2.2.4** The Control Room Supervisor may review the video timing to confirm early take-off.

**2.2.5** The Control Room Supervisor shall

- control withdrawals after the heats and/or semi-finals;
- enter results on official forms;
- list all new records established; and
- maintain scores where appropriate.

## **2.3 Starter**

**2.3.1** The Starter shall have full control of the swimmers from the time the Referee turns the swimmers over to him/her (Part Two, Article 2.1.5) until the race has commenced. The start shall be given in accordance with Part Two, Article 4.

**2.3.2** The Starter shall report a swimmer to the Referee for delaying the start, for willfully disobeying an order or for any other misconduct taking place at the start, but only the Referee may disqualify a swimmer for such delay, willful disobedience or misconduct.

**2.3.3** The starter shall have the power to decide whether the start is fair, subject only to the decision of the Referee.

**2.3.4** When starting an event, the Starter shall stand on the side of the pool within approximately five metres of the starting edge of the pool where the timekeepers can see and or hear the starting signal and the swimmers can hear the signal.

**2.3.5** The Starter shall report to the Referee any violation observed within their jurisdiction.

## **2.4 Call Room Supervisor**

**2.4.1** The Call Room Supervisor shall assemble swimmers prior to each event.

**2.4.2** The Call Room Supervisor shall report to the Referee any violation noted with regard to:

- swimwear;
- advertising (Part One, Article 8 - Advertising Identification); and
- if a swimmer is not present when called.

## **2.5 Chief Inspector of Turns**

**2.5.1** The Chief Inspector of Turns shall ensure that Inspectors of Turns fulfil their duties during the competition.

## **2.6 Inspectors of Turns**

**2.6.1** One Inspector of Turns shall be assigned to each lane at each end of the pool, to ensure swimmers comply with the relevant rules after the start, for each turn, and at the finish.

**2.6.2** Jurisdiction for the Inspector of Turns at the start end commences from the start signal until the completion of the first arm stroke, except in Breaststroke where it shall be the second arm stroke.



- 2.6.3** For each turn, jurisdiction for the Inspector of Turns commences from the beginning of the last arm stroke before touching and ending with the completion of the first arm stroke after the turn, except in Breaststroke where it shall be the second arm stroke.
- 2.6.4** Jurisdiction for the Inspector of Turns at the finish commences from the beginning of the last arm stroke before touching.
- 2.6.5** When a Backstroke ledge is being used, each inspector at the starting end shall install and remove the ledge. Once installed, the ledge shall be set at zero (0).
- 2.6.6** In individual events of 800 and 1500 metres, each Inspector of Turns at the start and turning end of the pool shall record the number of laps completed by the swimmer in his/her lane. The swimmers shall be informed of the remaining number of laps to be completed by displaying "lap cards" showing odd numbers at the turning end of the pool. Electronic equipment may be used, including underwater display.
- 2.6.7** Each Inspector at the starting end shall give a warning signal when the swimmer in their lane has two lengths plus five (5) metres to swim to finish in individual events of 800 and 1500 metres. The signal may be repeated after the turn until the swimmer has reached the five (5) metres mark on the lane rope. The warning signal may be by whistle or bell.
- 2.6.8** Each Inspector at the starting end shall determine, in relay events, whether the starting swimmer is in contact with the starting platform when the preceding swimmer touches the starting wall. When Automatic Equipment which judges relay take-offs is available, it shall be used in accordance with Part Two, Article 13.1.
- 2.6.9** Inspectors of Turns shall report to the Referee any violation observed within their jurisdiction.
- 2.7** **Judges of Stroke**
- 2.7.1** Judges of Stroke shall be located on each side of the pool.
- 2.7.2** Each Judge of Stroke shall ensure that the rules related to the style of swimming designated for the event are being observed and shall observe the turns and the finishes to assist the Inspectors of Turns.
- 2.7.3** Judges of Stroke shall report to the Referee any violation observed within their jurisdiction.
- 2.8** **Chief Timekeeper**
- 2.8.1** The Chief Timekeeper shall assign the seating positions for all timekeepers and the lanes for which they are responsible. It is advisable that there shall be three (3) timekeepers for each lane. If Automatic Officiating Equipment is not used there shall be two (2) additional timekeepers designated, either of whom shall be directed to replace a timekeeper whose watch did not start or stopped during an event, or who for any other reason is not able to record the time. When using digital watches, final time and place is determined by time.
- 2.8.2** When only one (1) timekeeper per lane is available, an extra timekeeper must be assigned in case of a malfunction of a watch. In addition, the chief timekeeper must always record the time of the winner of each race.
- 2.8.3** The Chief Timekeeper shall collect from the timekeepers in each lane a card showing the times recorded and, if necessary, inspect their watches.
- 2.8.4** The Chief Timekeeper shall record or examine the official time on the card for each lane.
- 2.9** **Timekeepers**
- 2.9.1** Each timekeeper shall take the time of the swimmers in the lane assigned to him in accordance with Part Two, Article 11.3.
- 2.9.2** Each timekeeper shall start their watch at the starting signal and shall stop it when the swimmer in their lane has completed the race. Timekeepers may be instructed by the Chief Timekeeper to record times at intermediate distances in races longer than 100 metres.
- 2.9.3** Promptly after the race, the timekeepers in each lane shall record the times of their watches on the card, give them to the Chief Timekeeper, and if requested present their watches for inspection. Their watches must be cleared at the short whistle of the Referee announcing the following race.
- 2.9.4** Unless video timing is used, it may be necessary to use the full complement of timekeepers even when Automatic Officiating Equipment is used.



**2.10 Finish Judges – if required**

**2.10.1** Finish judges shall be positioned in line with the finish where they have at all times a clear view of the course and the finish line.

**2.10.2** After each event the finish judges shall decide and report the placing of the swimmers according to the assignments given to them. Finish judges other than push- button operators shall not act as timekeepers in the same event.

**2.11 Chief Recorder (other than for Olympic Games and World Aquatics Championships)**

**2.11.1** The chief recorder is responsible for checking results from computer printouts or from results of times and placing in each event received from the referee. The chief recorder shall witness the referee's signing the results.

**2.12 Recorder (other than for Olympic Games and World Aquatics Championships)**

**2.12.1** The recorders shall control withdrawals after the heats or semi-finals, enter results on official forms, list all new records established, and maintain scores where appropriate.

**2.13 Video Review Supervisor**

**2.13.1** The Video Review Supervisor shall ensure that Video Review Judges are in their respective posts and fulfil their duties during the competition.

**2.13.2** The Video Review Supervisor shall review and confirm all rule infractions reported to them by the Video Review Judges.

**2.13.3** The Video Review Supervisor shall review and confirm all rule infractions reported to them at the request of the Referee.

**2.13.4** The Video Review Supervisor shall report to the Referee any violation confirmed in the video review.

**2.14 Video Review Judge**

**2.14.1** Each Video Review Judge shall ensure that the rules related to the style of swimming designated for the event are being observed and shall observe the turns and the finishes.

**2.14.2** Video Review Judge shall report any violation observed to the Video Review Supervisor. If the infraction is confirmed, the video review judge shall complete a disqualification card.

**2.15 Officials' Decision Making**

**2.15.1** Officials shall make their decision autonomously and independently of each other unless otherwise provided in Part Two.

**3 SEEDING OF HEATS, SEMI-FINALS AND FINALS**

The starting stations for all events in the Olympic Games, World Aquatics Championships, Regional Games and other World Aquatics competitions shall be by seeding as follows:

**3.1 Heats**

**3.1.1** The best competitive times of all entrants for the announced qualifying period prior to the entry deadline of the competition shall be submitted on entry forms or on-line, as requested, and listed in order of time by the Management Committee. Swimmers who do not submit official recorded times shall be considered the slowest and shall be placed at the end of the list with a no time. Placement of swimmers with identical times or of more than one swimmer without times shall be determined by draw. Swimmers shall be placed in lanes according to the procedures set forth in Part Two, Article 3.1.2 below. Swimmers shall be placed in trial heats according to submitted times in the following manner.

**3.1.1.1** If one heat, it shall be seeded as a final and swum only during the final session.

**3.1.1.2** If two heats, the fastest swimmer shall be seeded in the second heat, next fastest in the first heat, next fastest in the second heat, next in the first heat, etc.



- 3.1.1.3** If three heats, except 400m, 800m and 1500m events, the fastest swimmer shall be placed in the third heat, next fastest in the second, next fastest in the first. The fourth fastest swimmer shall be placed in the third heat, the fifth in the second heat, and the sixth fastest in the first heat, the seventh fastest in the third heat, etc.
- 3.1.1.4** If four or more heats, except 400m, 800m and 1500m events, the last three heats of the event shall be seeded in accordance with Part Two, Article 3.1.1.3 above. The heat preceding the last three heats shall consist of the next fastest swimmers; the heat preceding the last four heats shall consist of the next fastest swimmers, etc. Lanes shall be assigned in descending order of submitted times within each heat, in accordance with the pattern outlined in Part Two, Article 3.1.2 below.
- 3.1.1.5** For 400m, 800m and 1500m events, the last two heats of the event shall be seeded in accordance with Part Two, Article 3.1.1.2.
- 3.1.1.6** Exception: When there are two or more heats in an event, there shall be a minimum of three swimmers seeded into any one preliminary heat, but subsequent scratches may reduce the number of swimmers in such heat to less than three.
- 3.1.1.7** When a ten (10) lane pool is available and equal times are established for the 8th place in the heats or semi-finals of events in excess of 200m and, including relay events, lane O will be used. A random draw will be held to determine which competitor is allocated in lane 8 and lane O. In case of three (3) equal times for 8th place, lane 9 and O will be used with a random draw for lane 8, 9 and O. In the event that there are more than three (3) competitors or teams having equal times for 8th place in the heats or semi-finals, a swim-off may be held.
- 3.1.1.8** Where a 10 lane pool is not available provisions outlined in Part Two, Article 3.2.3 will apply.
- 3.1.2** Except for 50 metre events in 50 metre pools, assignment of lanes shall be (number 1 lane being on the right side of the pool (O when using pools with 10 lanes) when facing the course from the starting end) by placing the fastest swimmer or team in the centre lane in pool with an odd number of lanes, or in lane 3 or 4 respectively in pools having 6 or 8 lanes. In pools using 10 lanes, the fastest swimmer shall be placed in lane 4. The swimmer having the next fastest time is to be placed on their left, then alternating the others to right and left in accordance with the submitted times. Swimmers with identical times shall be assigned their lane positions by draw within the aforesaid pattern.
- 3.1.3** When 50 metre events are contested in 50 metre pools, the races may be swum, at the discretion of the Management Committee, either from the regular starting end to the turning end or from the turning end to the starting end, depending upon such factors as existence of adequate Automatic Equipment, starter's position, etc. The Management Committee should advise swimmers of their determination well before the start of the competition. Regardless of which way the race is swum, the swimmers shall be seeded in the same lanes in which they would be seeded if they were both starting and finishing at the starting end.
- 3.2** **Semi-Finals and Finals**
- 3.2.1** In the semi-finals heats shall be assigned as outlined in Part Two, Article 3.1.1.2.
- 3.2.2** Where no preliminary heats are necessary, lanes shall be assigned in accordance with Part Two, Article 3.1.2 above. Where preliminary heats or semi-finals have been held, lanes shall be assigned as in Part Two, Article 3.1.2 based, however, on times established in such heats.
- 3.2.3** In the event that swimmers from the same or different heats have equal times registered to 1/100 second for either the eighth/tenth place or sixteenth/twentieth place depending on the use of 8 or 10 lanes, there may be a swim-off to determine which swimmer shall advance to the appropriate finals. Such swim-off shall take place after all involved swimmers have completed their heats at a time agreed between the event management and the parties involved. Another swim-off may take place if equal times are registered again. If required, a swim off will take place to determine 1st and 2nd reserve if equal times are recorded.
- 3.2.4** Where one or more swimmers scratch from a semi-final or final reserves will be called in order of classifications in heats or semi-finals. Whenever possible, the event or events must be re-seeded and supplementary sheets must be issued detailing the changes or substitutions, as prescribed in Part Two, Article 3.1.2.
- 3.2.5** For heats, semi-finals and finals, swimmers shall report to the First Call Room at a time determined by the event management. After inspection, swimmers proceed to the final call-room.
- 3.3** In other competitions, the draw system may be used for assigning lane positions.



- 3.4** In the World Aquatics Swimming Championships (25m) and World Aquatics Junior Swimming Championships, the 800m Freestyle and the 1500m Freestyle may at the discretion of the Bureau be conducted on a timed final basis with the fastest heat only conducted during the finals session.

In distances of 50m, 100m and 200m, heats, semi-finals and finals will be held. At the World Aquatics Swimming Championships (25m) and World Aquatics Junior Swimming Championships events of 200m and above only heats and finals will take place.

## **4 THE START**

- 4.1** The start in Freestyle, Breaststroke, Butterfly and Individual Medley races shall be with a dive. On the long whistle (Part Two, Article 2.1.5) from the referee the swimmers shall step onto the starting platform and remain there. On the starter's command "take your marks", they shall immediately take up a starting position with at least one foot at the front of the starting platforms. The position of the hands is not relevant. When all swimmers are stationary, the Starter shall give the starting signal.
- 4.2** The start in the Backstroke and Medley Relay races shall be from the water. At the referee's first long whistle (Part Two, Article 2.1.5), the swimmers shall immediately enter the water. At the referee's second long whistle the swimmers shall return without undue delay to the starting position (Part Two, Article 6.1). When all swimmers have assumed their starting positions, the starter shall give the command "take your marks". When all swimmers are stationary, the starter shall give the starting signal.
- 4.3** In Olympic Games, World Aquatics Championships and other World Aquatics events the command "Take your marks" shall be in English and the start shall be by multiple loudspeakers, mounted one at each starting platform.
- 4.4** Any swimmer initiating a start before the signal may be disqualified. If the starting signal sounds before the disqualification is declared, the race shall continue and the swimmer or swimmers shall be disqualified upon completion of the race. If the disqualification is declared before the starting signal, the signal shall not be given, but the remaining swimmers shall be called back and start again. The referee repeats the starting procedure beginning with the long whistle (the second one for Backstroke) as per Part Two, Article 2.1.5.

## **5 FREESTYLE**

- 5.1** Freestyle means that in an event so designated the swimmer may swim any style, except that in individual medley or medley relay events, freestyle means any style other than backstroke, breaststroke or butterfly.
- 5.2** Some part of the swimmer must touch the wall upon completion of each length and at the finish.
- 5.3** Some part of the swimmer must break the surface of the water throughout the race, except it shall be permissible for the swimmer to be completely submerged during the turn and for a distance of not more than 15 metres after the start and each turn. By that point, the head must have broken the surface.

## **6 BACKSTROKE**

- 6.1** Prior to the starting signal, the swimmers shall line up in the water facing the starting end, with both hands holding the starting grips. Standing in or on the gutter or bending the toes over the lip of the gutter is prohibited. When using a backstroke ledge at the start, at least one toe of each foot must be in contact with the end wall or face of the touchpad. Bending the toes over the top of the touchpad is prohibited.
- 6.2** At the signal for starting and after turning the swimmer shall push off and swim upon their back throughout the race except when executing a turn as set forth in Part Two, Article 6.4. The normal position on the back can include a roll movement of the body up to, but not including 90 degrees from horizontal. The position of the head is not relevant.
- 6.3** Some part of the swimmer must break the surface of the water throughout the race, except that once some part of the head of the swimmer has passed the 5 metres mark immediately prior to reaching for the finish, the swimmer may be completely submerged. It is also permissible for the swimmer to be completely submerged during the turn, and for a distance of not more than 15 metres after the start and each turn. By that point the head must have broken the surface.



- 6.4** When executing the turn there must be a touch of the wall with some part of the swimmer's body. During the turn the shoulders may be turned over the vertical to the breast after which an immediate continuous single arm pull or immediate continuous simultaneous double arm pull may be used to initiate the turn. The swimmer must have returned to the position on the back upon leaving the wall.
- 6.5** Upon the finish of the race the swimmer must touch the wall while on the back.

## **7 BREASTSTROKE**

- 7.1** After the start and after each turn, the swimmer may take one arm stroke completely back to the legs during which the swimmer may be submerged. At any time prior to the first Breaststroke kick after the start and after each turn a single butterfly kick is permitted. The head must break the surface of the water before the hands turn inward at the widest part of the second stroke.
- 7.2** From the beginning of the first arm stroke after the start and after each turn, the body shall be on the breast. It is not permitted to roll onto the back at any time except at the turn after the touch of the wall where it is permissible to turn in any manner as long as the body is on the breast when leaving the wall. From the start and throughout the race the stroke cycle must be one arm stroke and one leg kick in that order. All movements of the arms shall be simultaneous without alternating movement.
- 7.3** The hands shall be pushed forward together from the breast on, under, or over the water. The elbows shall be under water except for the final stroke before the turn, during the turn and for the final stroke at the finish. The hands shall be brought back on or under the surface of the water. The hands shall not be brought back beyond the hip line, except during the first stroke after the start and each turn.
- 7.4** During each complete cycle, some part of the swimmer's head must break the surface of the water. All movements of the legs shall be simultaneous without alternating movement.
- 7.5** The feet must be turned outwards during the propulsive part of the kick. Alternating movements or downward butterfly kicks are not permitted except as in Part Two, Article 7.1. Breaking the surface of the water with the feet is allowed unless followed by a downward butterfly kick.
- 7.6** At each turn and at the finish of the race, the touch shall be made with both hands separated\* and simultaneously at, above, or below the water level. At the last stroke before the turn and at the finish an arm stroke not followed by a leg kick is permitted. The head may be submerged after the last arm pull prior to the touch, provided it breaks the surface of the water at some point during the last complete or incomplete cycle preceding the touch.

\*\*"Separated" means that the hands cannot be stacked one on top of the other. It is not necessary to see space between the hands. Incidental contact at the fingers is not a concern.

## **8 BUTTERFLY**

- 8.1** From the beginning of the first arm stroke after the start and each turn, the body shall be kept on the breast. It is not permitted to roll onto the back at any time, except at the turn after the touch of the wall where it is permissible to turn in any manner as long as the body is on the breast when leaving the wall.
- 8.2** Both arms shall be brought forward simultaneously over the water and brought backward simultaneously under the water through-out the race, subject to Part Two, Article 8.5.
- 8.3** All up and down movements of the legs must be simultaneous. The legs or the feet need not be on the same level, but they shall not alternate in relation to each other. A breaststroke kicking movement is not permitted.
- 8.4** At each turn and at the finish of the race, the touch shall be made with both hands separated\*\* and simultaneously, at, above or below the water surface.
- 8.5** At the start and at turns, a swimmer is permitted one or more leg kicks and one arm pull under the water, which must bring him to the surface. It shall be permissible for a swimmer to be completely submerged for a distance of not more than 15 metres after the start and after each turn. By that point, the head must have broken the surface. The swimmer must remain on the surface until the next turn or finish.

\*\*\*"Separated" means that the hands cannot be stacked one on top of the other. It is not necessary to see space between the hands. Incidental contact at the fingers is not a concern.



## **9 MEDLEY SWIMMING**

- 9.1** In individual medley events, the swimmer covers the four swimming strokes in the following order: Butterfly, Backstroke, Breaststroke and Freestyle. Each of the strokes must cover one quarter (1/4) of the distance.
- 9.2** In Freestyle the swimmer must be on the breast except when executing a turn. The swimmer must return to the breast before any kick or stroke. Leaving the wall on the back during the freestyle portion is permissible but no kicking action is permitted until the swimmer has returned past the vertical to the breast at which point kicking, including a butterfly kick(s), may commence.
- 9.3** In Medley relay events, swimmers will cover the four swimming strokes in the following order: Backstroke, Breaststroke, Butterfly and Freestyle. Each of the strokes must cover one quarter (1/4) of the distance.
- 9.4** Each section must be finished in accordance with the rule which applies to the stroke concerned.

## **10 THE RACE**

- 10.1** All individual races must be held as separate gender events.
- 10.2** A swimmer swimming over the course alone shall cover the whole distance to qualify. A swimmer who does not complete the whole distance in accordance with the relevant World Aquatics rules shall be disqualified.
- 10.3** On the pool deck, after respecting the presentation protocol outlined in Part Two, Article 1.5, the competitors must immediately remove all clothing except for swimwear.
- 10.4** The swimmer must remain and finish the race in the same lane in which he/she started.
- 10.5** In all events, a swimmer when turning shall make physical contact with the end of the pool or course. The turn must be made from the wall, and it is not permitted to take a stride or step from the bottom of the pool.
- 10.6** Standing on the bottom during freestyle events or during the freestyle portion of medley events shall not disqualify a swimmer, but they shall not walk.
- 10.7** Pulling on the lane rope is not allowed.
- 10.8** Obstructing another swimmer by swimming across another lane or otherwise interfering shall disqualify the offender. Should the foul be intentional, the referee shall report the matter to the Member promoting the race, and to the Member of the swimmer so offending.
- 10.9** Any swimmer not entered in a race, who enters the water in which an event is being conducted before all swimmers therein have completed the race, shall be disqualified from their next scheduled race in the meet.
- 10.10** There shall be four swimmers on each relay team. Mixed relays may be swum. Mixed Relays must consist of two (2) Men and two (2) Women. Split times achieved in these events cannot be used for records and/or entry purposes.
- 10.11** Relay exchanges must commence from the starting platform. Running starts from the pool deck are not permitted.
- 10.12** In relay events, the team of a swimmer whose feet lose touch with the starting platform before the preceding team-mate touches the wall shall be disqualified.
- 10.13** Any relay team shall be disqualified from a race if a team member, other than the swimmer designated to swim that length, enters the water when the race is being conducted, before all swimmers of all teams have finished the race.
- 10.14** The members of a relay team and their order of competing must be nominated before the race. Any relay team member may compete in a race only once. The composition of a relay team may be changed between the heats and finals of an event, provided that it is made up from the list of swimmers properly entered by a member for that event. Failure to swim in the order listed will result in disqualification. Substitutions may be made only in the case of a documented medical emergency.
- 10.15** Any swimmer having finished their race, or their distance in a relay event, must leave the pool as soon as possible without obstructing any other swimmer who has not yet finished their race. Otherwise, the swimmer committing the fault, or their relay team, shall be disqualified.



**10.16** Should a foul endanger the chance of success of a swimmer, the referee shall have the power to allow him to compete in the next heat or, should the foul occur in a final event or in the last heat, he/she may order it to be re-swum.

**10.17** No pace-making shall be permitted, nor may any device be used or plan adopted which has that effect.

## **11 TIMING**

**11.1** The operation of Automatic Officiating Equipment shall be under the supervision of appointed officials. Times recorded by Automatic Equipment shall be used to determine the winner, all placing and the time applicable to each lane. The placing and times so determined shall have precedence over the decisions of timekeepers. In the event that a break-down of the Automatic Equipment occurs or that it is clearly indicated that there has been a failure of the Equipment, or that a swimmer has failed to activate the Equipment, the recordings of the timekeepers shall be official (See Part Two, Article 13.3). In the event that there is failure of all timing devices in a lane then the swimmer may be offered a reswim.

**11.2** When Automatic Officiating Equipment is used, the results shall be recorded only to 1/100 of a second. In the event of equal times, all swimmers who have recorded the same time at 1/100 of a second shall be accorded the same placing. Times displayed on the electronic scoreboard should show 1/100 of a second.

**11.3** Any timing device that is terminated by an official shall be considered a watch. Such manual times must be taken by three timekeepers appointed or approved by the Member in the country concerned. All watches shall be certified as accurate to the satisfaction of the governing body concerned. Manual timing shall be registered to 1/100 of a second. Where no Automatic Equipment is used, official manual times shall be determined as follows:

**11.4** If two (2) of the three (3) watches record the same time and the third disagrees, the two identical times shall be the official time.

**11.5** If all three (3) watches disagree, the watch recording the intermediate time shall be the official time.

**11.6** With only two (2) out of three (3) watches working the average time shall be the official time. When this calculation results in a value that is expressed in thousandths of a second, the final digit shall be dropped without rounding.

**11.7** Should a swimmer be disqualified during or following an event, such disqualification should be recorded in the official results, but no time or place shall be recorded or announced.

**11.8** In the case of a relay disqualification, legal splits up to the time of the disqualification shall be recorded in the official results.

**11.9** All 50 metre and 100 metre splits shall be recorded for lead-off swimmers during relays and published in the official results.

## **12 WORLD RECORDS**

**12.1** For World Records and World Junior Records in **50 metre courses**, the following distances and styles for both sexes shall be recognised:

<b>Freestyle</b>	50, 100, 200, 400, 800 and 1500 metres
<b>Backstroke</b>	50, 100 and 200 metres
<b>Breaststroke</b>	50, 100 and 200 metres
<b>Butterfly</b>	50, 100 and 200 metres
<b>Individual Medley</b>	200 and 400 metres
<b>Freestyle Relays</b>	4x100 and 4x200 metres
<b>Medley Relay</b>	4x100 metres
<b>Mixed Relays</b>	4x100 metres Freestyle and 4x100 metres Medley

**12.2** For World Records and World Junior Records in **25 metre courses**, the following distances and styles for both sexes shall be recognised:



<b>Freestyle</b>	50, 100, 200, 400, 800 and 1500 metres
<b>Backstroke</b>	50, 100 and 200 metres
<b>Breaststroke</b>	50, 100 and 200 metres
<b>Butterfly</b>	50, 100 and 200 metres
<b>Individual Medley</b>	100, 200 and 400 metres
<b>Freestyle Relays</b>	4x50, 4x100 and 4x200 metres
<b>Medley Relay</b>	4x50 and 4x100 metres
<b>Mixed Relays</b>	4x50 metres Freestyle and 4x50 metres Medley

- 12.3** The age groups for World Junior Records are the same as for the World Aquatics Junior Swimming Championships.
- 12.4** Members of relay teams must be of the same nationality.
- 12.5** All records must be made in scratch competition or an individual race against time, held in public and announced publicly by advertisement at least three days before the attempt is to be made. In the event of an individual race against time being sanctioned by a Member Federation, as a time trial during a competition, then an advertisement at least three (3) days before the attempt is to be made shall not be necessary.
- 12.6** The length of each lane of the course must be certified by a surveyor or other qualified official appointed or approved by the Member Federation in the country in which it is situated.
- 12.7** Where a moveable bulkhead is used, course measurement of the lane must be confirmed at the conclusion of the session during which the time was achieved.
- 12.8** World Records and World Junior Records will be accepted only when times are recorded by Automatic Officiating Equipment, or Semi-Automatic Officiating Equipment in the case of Automatic Officiating Equipment system malfunction.
- 12.9** World Records and World Junior Records can be established only by swimmers wearing World Aquatics approved swimwear (see Part Two, Article 15).
- 12.10** Times which are equal to 1/100 of a second will be recognised as equal records and swimmers achieving these equal times will be called «Joint Holders». Only the time of the winner of a race may be submitted for a World Record – except for World Juniors Records. In the event of a tie in a record-setting race, each swimmer who tied shall be considered a winner.
- 12.11** Worlds Records and World Junior Records can be established only in water with less than 3 gr/litre of salt. No World Records will be recognized in any kind of sea or ocean water.
- 12.12** The first swimmer in a relay, except in mixed relays, may apply for a World Record or a World Junior Record. Should the first swimmer in a relay team complete his/her distance in record time in accordance with the provisions of this subsection, his/her performance shall not be nullified by any subsequent disqualification of his/her relay team for violations occurring after his/her distance has been completed.
- 12.13** A swimmer in an individual event may apply for a World Record or a World Junior Records at an intermediate distance if he/she or his/her coach or manager specifically requests the referee that their performance be especially timed or if the time at the intermediate distance is recorded by Automatic Officiating Equipment. Such swimmer must complete the scheduled distance of the event to apply for a record at the intermediate distance.
- 12.14** Applications for World Records and World Junior Records must be made on the World Aquatics official form by the responsible authority of the organizing or management committee of the competition and signed by an authorized representative of the Member Federation in the country of the swimmer, certifying that all regulations have been observed including certification of the pool measurement and that the athlete was subject to an anti-doping test immediately after the race, or at the latest, within 24 hours of the conclusion of the Event, and such test returned a negative finding. When a relay team breaks or equals a World Record / World Junior Record, only the four Athletes who swam this specific race must return a negative finding. The application form shall be forwarded to the Executive Director of World Aquatics within fourteen (14) days after the performance.
- 12.15** A claim of a World Record or a World Junior Record performance shall be provisionally reported by e-mail to the Executive Director of World Aquatics within seven (7) days of the performance.



- 12.16** The Member Federation in the country of the swimmer should report this performance by letter to the Executive Director of World Aquatics for information and action, if necessary, to assure that the official application has been properly submitted by the appropriate authority.
- 12.17** On receipt of the official application, and upon satisfaction that the information contained in the application, including a certification of the pool measurement and a negative doping control test certificate, is accurate, the Executive Director of World Aquatics shall declare the new World Record or World Junior Record, see that such information is published, and see that certificates are provided to those persons whose applications have been accepted.
- 12.18** All records made during the Olympic Games, World Aquatics Championships, World Aquatics Junior Swimming Championships and Swimming World Cups shall be automatically approved.
- 12.19** If the procedure of Part Two, Article 12.14 has not been followed, the Member Federation in the country of a swimmer can apply for a World Record or a World Junior Record in default thereof. After due investigation, the Executive Director of World Aquatics is authorised to accept such record if the claim is found to be correct.
- 12.20** If the application for a World Record or a World Junior Record is accepted by World Aquatics, a diploma, signed by the President of World Aquatics shall be forwarded by the Executive Director to the Member Federation in the country of the swimmer for presentation to the swimmer in recognition of the performance. A fifth World Record diploma will be issued to all Member Federations whose relay teams establish a World Record or a World Junior Record. This diploma is to be retained by the Member Federation.
- 12.21** From time to time, World Aquatics may add new events for which swimmers may establish World Records or World Junior Records. For each such event, World Aquatics will establish Target Times; if a swimmer achieves a time that is better than the Target Time, it shall be considered a World Record or World Junior Record, as long as all requirements in Part Two, Article 12 are met.

### **13 AUTOMATIC OFFICIATING PROCEDURE**

- 13.1** When Automatic Officiating Equipment (See Part Two, Article 16.3 - Automatic Officiating Equipment for Swimming) is used in any competition, the placing and times so determined and relay take-offs judged by such equipment shall have precedence over the timekeepers and Inspectors of Turns.
- 13.2** When the Automatic Officiating Equipment fails to record the place and/or time of one or more swimmers in a given race:
- 13.2.1** Record all available Automatic Officiating Equipment times and places,
- 13.2.2** Record all human times and places.
- 13.2.3** The official place will be determined as follows:
- 13.2.3.1** A swimmer with an Automatic Officiating Equipment time and place must retain their relative order when compared with the other swimmers having an Automatic Officiating Equipment time and place within that race.
- 13.2.3.2** A swimmer not having an Automatic Officiating Equipment place but having an Automatic Officiating Equipment time will establish their relative order by comparing their Automatic Officiating Equipment time with the Automatic Officiating Equipment times of the other swimmers.
- 13.2.3.3** A swimmer having neither an Automatic Officiating Equipment place nor an Automatic Officiating Equipment time shall establish their relative order by the time recorded by the Semi-Automatic Officiating Equipment or by watches.
- 13.3** The official time will be determined as follows:
- 13.3.1** The official time for all swimmers having an Automatic Officiating Equipment time will be that time.
- 13.3.2** The official time for all swimmers not having an Automatic Officiating Equipment time will be the times recorded by Semi-Automatic Officiating Equipment or watches.
- 13.4** To determine the relative order of finish for the combined heats of an event, proceed as follows:
- 13.4.1** The relative order of all swimmers will be established by comparing their official times.





- 13.4.2** If a swimmer has an official time which is tied with the official time(s) of one or more swimmers, all swimmers having that time shall be tied in their relative order of finish in that event.

## **14 AGE GROUP RULES – SWIMMING**

### **14.1 World Aquatics Junior Swimming Championships**

Age groups shall be between 14-18 years, as of 31st December in the year of competition, for both Boys and Girls.

- 14.2** Minimum age for Olympic Games, World Aquatics Championships and World Aquatics Swimming Championships (25m).

The minimum age for swimmers competing in the Olympic Games, World Aquatics Championships and World Aquatics Swimming Championships (25m) shall be the same as the minimum age for the World Aquatics Junior Swimming Championships: Girls and Boys, at least 14 years of age, on 31<sup>st</sup> December in the year of competition. Younger competitors may participate in these competitions if they have achieved at least the “B” Standard Entry Time in the respective event.

- 14.3** Federations may adopt their own Age Group rules, using World Aquatics Competition Regulations.

## **15 SWIMWEAR AND WEARABLES**

- 15.1** Competitors must wear only one swimsuit in one or two pieces. No additional items, like arm bands or leg bands shall be regarded as parts of a swimsuit. All swimsuits shall comply with the requirements set forth in these Competition Regulations.

- 15.2** For swimming competitions, swimsuits for men shall not extend above the navel nor below the knee. For women, the swimsuit shall not cover the neck, nor extend past the shoulder, nor below knee. The swimsuits shall be made from textile materials.

- 15.3** No swimmer shall be permitted to use or wear any device or swimsuit that may aid his/her speed, buoyancy or endurance during a competition (such as webbed gloves, flippers, fins, power bands, or adhesive substances, etc.). The use of technology and automated data collection devices is permissible for the sole purpose of collecting data. Automated devices shall not be utilised to transmit data, sounds, or signals to the swimmer and may not be used to aid their speed. Goggles may be worn. As a consequence of injury, it is permissible to tape not more than one or two fingers or toes. Any other kind of tape on the body is not permitted unless approved by the Referee or other designated person.

- 15.4** A World Record (including Junior World Record and Masters World Record) will only be recognised by World Aquatics if approved swimwear has been used.

World Aquatics may request the Athlete to submit her/his swimsuit worn during the World Record for conducting further analysis in its laboratory.

## **16 SWIMMING FACILITIES AND EQUIPMENT**

### **16.1 Swimming Facilities**

#### **16.1.1 Length**

##### **16.1.1.1 50.000 metres**

When touch panels of Automatic Officiating Equipment are used on the starting end, or additionally on the turning end, the pool must be of such length that ensures the required distance of 50.000 metres between the two panels.

##### **16.1.1.2 25.000 metres**

When touch panels of Automatic Officiating Equipment are used on the starting end, or additionally on the turning end, the pool must be of such length that ensures the required distance of 25.000 metres between the two panels.

**16.1.2 Dimensional Tolerances**
**16.1.2.1 50m swimming pools**

The admissible tolerance in 50.000 m swimming pools will be: +0.010, and -0.000 metre when touch panels are installed.

Tolerances will be measured as follows:

For swimming pools with touch panels of Automatic Officiating Equipment on both ends the Wall to Wall distance shall be:

Minimum 50.020 metre / Maximum 50.030 metre.

Tolerances have to be consistent 0.300 metre above to 0.800 metre below the water surface.

These measurements should be certified by a surveyor or other qualified official, appointed or approved by the Member in the country in which the pool is situated.

**16.1.2.2 25m swimming pools**

The admissible tolerance in 25.000 m swimming pools will be +0.010, and -0.000 metre when touch panels are installed.

Tolerances will be measured as follows:

For swimming pools with touch panels of Automatic Officiating Equipment on both ends the Wall to Wall distance shall be:

Minimum	Maximum
25.020 metre	25.030 metre

For swimming pools with a touch panel of Automatic Officiating Equipment on one end the Wall to Wall distance shall be:

Minimum	Maximum
25.010 metre	25.020 metre

Tolerances have to be consistent 0.300 metre above to 0.800 metre below the water surface.

These measurements should be certified by a surveyor or other qualified official, appointed or approved by the Member in the country in which the pool is situated.

**16.1.3 Width**

There is no minimum width requirement. However, the width of the pool has to comply with the provision in Part Two, Article 16.1.6 - Lanes.

**16.1.4 Depth**

A minimum depth of 1.35 metres, extending from 1.0 metre to at least 6.0 metres from the end wall is required for pools with starting blocks. A minimum depth of 1.0 metre is required elsewhere.

**16.1.5 Walls**

**16.1.5.1** End walls shall be vertical, parallel and form 90-degree right angles to the swimming course and to the surface of the water. They shall be constructed of solid material, with a slip-resistant surface extending 0.8 metre below the water surface, so as to enable the competitor to touch and push off in turning without hazard. The admissible tolerance in walls verticality will be  $\pm 0.3$  degrees.

**16.1.5.2** Rest ledges along the pool walls are permitted; they must be not less than 1.2 metres below the water surface, and may be 0.1 metre to 0.15 metre wide. Both internal and external ledges are acceptable, however internal ledges are preferred.

**16.1.5.3** Gutters may be placed on all four walls of the pool. If end wall gutters are installed, they must allow for attachment of touch panels to the required 0.3 metre above the water surface. They must be covered with a suitable grill or screen.

**16.1.6 Lanes**

There is no minimum number of lanes. Lanes shall be at least 2.5 metres wide, first and last lane may be 2.4 metres wide with 2 spaces of at least 0.1 metres wide outside of the first and the last lanes.

**16.1.7 Lane Ropes****16.1.7.1**

The main function of a lane rope is not only to separate swimming lanes, but to reduce the pool waves. A lane rope should have the properties to reduce the waves going through to the other side of rope or bouncing back into the swimming lane.

Lane ropes shall extend the full length of the course and components not contributing to its wave reduction function, such as tension spring and take-up reel, shall measure less than 200mm each end of rope.

Lane rope should be secured at each end wall to anchor brackets recessed into the end walls. If anchor placement is on pool deck, an extender, firm and non-elastic, should be in place. The installed lane rope should stay in the pool water. The anchor, including extender, shall not extend more than 10mm into the pool. The anchor shall not influence the length of the lane rope by more than  $\pm 10$ mm each end of rope.

The anchor shall be positioned so that the wave reducing components at each end wall of the pool shall be 50% below the surface of the water. Anchors should be installed to withstand 20kN. Each lane rope will consist of wave reducing components placed end-to-end having a minimum diameter of 0.10 metre. The design of discs and floats should be so that the floats, by themselves, do not influence the length of the lane rope. A float should be an integral part in between two discs. The lane rope length of the course shall have a negative buoyancy in such a way that at least one half to maximum two thirds of the height of the wave reducing components should be beneath the water surface.

The take-up reel of the lane rope should require a tool to lock tensioning into position and to prevent non-authorized tampering. The lane rope shall be equipped with a tension spring, absorbing sudden high point loads and a wire withstanding a tensile force of 12kN.

In an eight (8) lane pool, lane ropes shall extend the full length of the course, secured at each end wall to anchor brackets recessed into the end walls. The anchor shall be positioned so that the floats at each end wall of the pool shall be on the surface of the water. Each lane rope will consist of floats placed end-to-end having a minimum diameter of 0.10 metre to a maximum of 0.15 metre.

In a swimming pool the colour of the lane ropes should be as follows, although variations in the colour scheme can be used:

- Two (2) GREEN ropes for lanes 1 and 8
- Four (4) BLUE ropes for lanes 2, 3, 6 and 7
- Three (3) YELLOW ropes for lanes 4 and 5

The floats extending for a distance of 5.0 metres from each end of the pool shall be of RED colour.

There shall not be more than one lane rope between each lane. The lane ropes shall be firmly stretched and the tensions should be 1-1,2kN.

*See Swimming Diagrams, Part Two, Annex 1, 6, and 7*

**16.1.7.2**

At the 15-metre mark from each end wall of the pool the components shall be distinct in colour from the surrounding components.

**16.1.7.3**

In 50 metre pools the components shall be distinct to mark 25 metres.

**16.1.7.4**

Lane numbers of soft material may be placed on the lane ropes at the start and turning end of the pool.

**16.1.8****Starting Platforms**

Starting Platforms shall be firm and give no springing effect. The height of the platform above the water surface shall be from 0.5 metre to 0.75 metre. The surface area shall be at least 0.5 metre x 0.5 metre and covered with a slip-resistant material.



Maximum slope shall not be more than 10 degrees. The starting platform may have an adjustable setting back plate. The platform shall be constructed so as to permit the gripping of the platform by the swimmer in the forward start at the front and the sides; it is recommended that, if the thickness of the starting platform exceeds 0.04 metre, grips of at least 0.1 metre width on each side and 0.4 metre width in the front be cut out to 0.03 metre from the surface of the platform.

Handgrips for the forward start may be installed on the sides of the starting platforms. Handgrips for backstroke starts shall be placed within 0.3 metre to 0.6 metre above the water surface both horizontally and vertically. They shall be parallel to the surface of the end wall and must not protrude beyond the end wall.

A minimum depth of 1.35 metres, extending from 1.0 metre to at least 6.0 metres from the end wall is required for pools with starting blocks. Electronic read-out boards may be installed under the blocks. Flashing is not allowed. Figures must not move during a backstroke start.

### 16.1.9 Numbering

Each starting block must be distinctly numbered on all four sides, clearly visible. It is recommended that lane number 0 shall be on the right-hand side when facing the course from the starting end with exception of 50m events, which may start from the opposite end. Touch panels may be numbered on the top part.

### 16.1.10 Backstroke Turn Indicators

Flagged ropes shall be suspended across the pool, 1.8 metres above the water surface, from fixed standards placed 5.0 metres from each end wall. Distinctive marks must be placed on both sides of the pool, and where possible on each lane rope, 15.0 metres from each end wall.

Flags must be fixed to the ropes having the following dimensions: 0.20 metres on the rope forming a triangle measuring 0.40 metres on the sides. The distance between each flag must be 0.25 metres. If the flags are printed with or support / carry any signage this must be approved in advance by World Aquatics.

### 16.1.11 Backstroke Ledge

Backstroke ledges conforming to the specification set out below shall be used in all World Aquatics Championships and Competitions.

**The ledge: (see diagram below)**

- shall be adjustable to 4 cm above or 4 cm below the water level and may not be used outside of this range;
- is a minimum of 60 cm in length;
- must be 8 cm in height, 2 cm at the width with 10 degrees of slope.

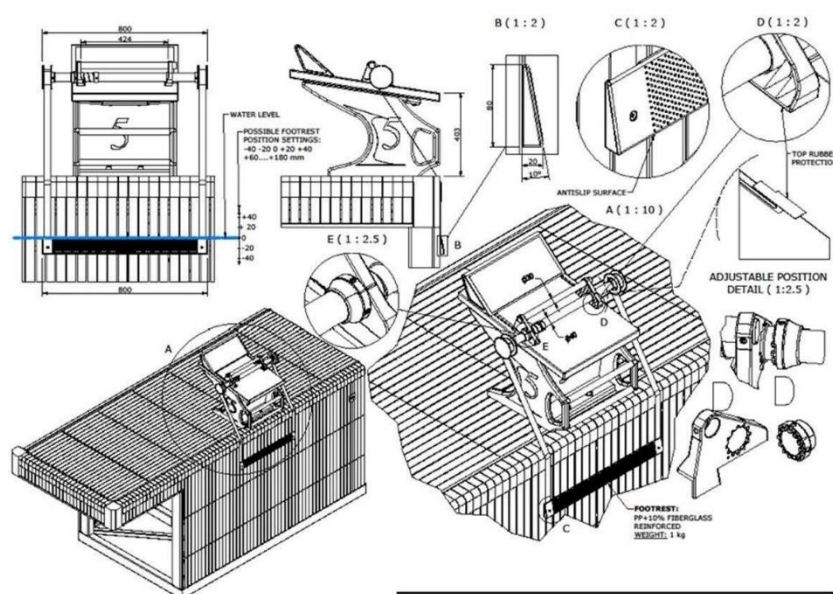

<b>BACKSTROKE LEDGE</b>	
-------------------------	--

**16.1.12 False Start Rope**

False Start Rope may be suspended across the pool not less than 1.2 metres above the water level from fixed standards placed 15.0 metres in front of the starting end. It shall be attached to the standards by a quick release mechanism. The rope must effectively cover all lanes when activated.

**16.1.13 Water conditions**
**16.1.13.1 Water Temperature**

Water temperature shall be 25° to 28°C.

**16.1.13.2 Movement**

During competition, the water in the pool must be at a constant level, with no appreciable movement.

In order to keep the water level, preserve the transparency of water and take into consideration the health regulations in force in most countries, inflow and outflow has to be regulated as follows:

- 220 to 250 m<sup>3</sup>/h for 50.00 m pools
- 150 to 180 m<sup>3</sup>/h for 33.33 m pools
- 120 to 150 m<sup>3</sup>/h for 25.00 m pools

In daily use, inflow and outflow has to follow the health regulation of each country.

At these turnover rates, the water distribution has to be such that no appreciable current or turbulence is created.

“Appreciable current” is defined as water movement that can move a floating basketball (filled with 6 litres of water to obtain the right buoyancy) in one direction for more than 1,25m in 60 seconds.

The practical way to test this is to install two floating lines crosswise in a swim lane (to obtain a square with 2,5m size, ref. Image 1) and then to leave the basketball in the central point of the square. If the ball does not touch any of the four lane ropes within 60 seconds, the turbulence test is successful.

Test should be repeated in lanes 1,3,6,8 on two sides, at 5m from each end of the pool (end wall or bulkhead).

**16.1.13.3 Salinity of the water**

World Records and World Junior Records can be established only in water with less than 3 gr/litre of salt.

No World Records will be recognized in any kind of sea or ocean water.

**16.1.14 Lighting**

Light intensity over starting platforms and turning ends shall not be less than 600 lux.

**16.1.15 Lane Markings**

Lane Markings shall be of a dark contrasting colour, placed on the floor of the pool in the centre of each lane.



<b>Width:</b>	minimum 0.2 metre, maximum 0.3 metre.
<b>Length:</b>	46.0 metres for 50 metre long pools; 21.0 metres for 25 metre long pools.

Each lane line shall end 2.0\* metres from the end wall of the pool with a distinctive cross line 1.0 metre long and of the same width as the lane line. The distance between the centre points of each lane shall be 2.5 metres.

\*Pool length tolerances must be considered.

Target lines shall be placed on the end walls or on the touch panels, in the centre of each lane, of the same width as the lane lines.

They shall extend without interruption from the deck edge (curb), to the floor of the pool to a maximum of 3 metres. A cross line 0.5 metre long shall be placed 0.3 metre below the water surface, measured to the centre point of the cross line.

For 50m and 25m pools constructed after 1st January 2006, cross lines 0.5 metre long shall be placed at the 15 metre mark from each end of the pool. After October 2013 this shall be measured from the end wall to the centre point of the cross line.

#### **16.1.16 Bulkheads**

When a bulkhead serves as an end wall, it must extend the full width of the course and present a solid smooth, non-slippery stable vertical surface on which touch pads may be mounted extending not less than 0.8m below and 0.3m above the surface of the water, and must be free of hazardous openings above or below the waterline which may be penetrated by a swimmer's hands, feet, toes or fingers. A bulkhead must be of a design that provides for the free movement of officials along its length without such movement creating any appreciable current or water turbulence.

### **16.2 Swimming Facilities for Olympic Games and World Aquatics Championships**

#### **16.2.1 Length**

50.0 metres between the Automatic Officiating Equipment touch panels, except for the World Aquatics Swimming Championships (25m), which shall be 25.0 metres between the Automatic Officiating Equipment touch panels at the starting end and the wall or touch panels at the turning end.

#### **16.2.2 Dimensional Tolerances**

##### **16.2.2.1 50m swimming pools**

The admissible tolerance in 50.00 m swimming pools will be +0.010, and -0.000 metre when touch panels are installed.

Tolerances will be measured as follows:

For swimming pools with touch panels of Automatic Officiating Equipment on both ends the Wall-to-Wall distance shall be: Minimum 50.020 metre / Maximum 50.030 metre.

Tolerances have to be consistent 0.300 metre above to 0.800 metre below the water surface.

These measurements should be certified by a surveyor or other qualified official, appointed or approved by the Member in the country in which the pool is situated.

*See Swimming Diagrams in Part Two, Annex 1, 2, 3, and 4*

##### **16.2.2.2 25m swimming pools**

The admissible tolerance in 25.00 m swimming pools will be +0.010, and -0.000 metre when touch panels are installed.

Tolerances will be measured as follows:

For swimming pools with touch panels of Automatic Officiating Equipment on both ends the Wall to Wall distance shall be:

Minimum 25.020 metre / Maximum 25.030 metre.



For swimming pools with a touch panel of Automatic Officiating Equipment on one end the Wall to Wall distance shall be:

Minimum 25.010 metre / Maximum 25.020 metre.

Tolerances have to be consistent 0.300 metre above to 0.800 metre below the water surface.

These measurements should be certified by a surveyor or other qualified official, appointed or approved by the Member in the country in which the pool is situated.

### **16.2.3 Width**

#### **16.2.3.1 Olympic Games**

Permanent Swimming Pools: A minimum of 25.00 metres Temporary Swimming Pools: 26.00 metres.

#### **16.2.3.2 World Aquatics Championships**

Permanent Swimming Pools: A minimum of 25.00 metres Temporary Swimming Pools: 26.00 metres.

### **16.2.4 Depth**

#### **16.2.4.1 Olympic Games and World Aquatics Championships (50m)**

A minimum of 2.5 metres.

#### **16.2.4.2 World Aquatics Swimming Championships (25m)**

A minimum of 2.0 metres, 2.5 metres preferred.

#### **16.2.4.3 When the pool is used for multi-sports (i.e., Artistic Swimming and Swimming) at either the Olympic Games or World Aquatics Championships**

A minimum of 3 metres is required.

### **16.2.5 Walls**

**16.2.5.1** End walls shall be vertical, parallel and form 90-degree right angles to the swimming course and to the surface of the water. They shall be constructed of solid material, with a slip-resistant surface extending 0.8 metre below the water surface, so as to enable the competitor to touch and push off in turning without hazard.

The admissible tolerance in walls verticality will be  $\pm 0.3$  degrees.

**16.2.5.2** Rest ledges along the pool walls are permitted; they must be not less than 1.2 metres below the water surface, and may be 0.1 metre to 0.15 metre wide. Both internal and external ledges are acceptable, however internal ledges are preferred.

**16.2.5.3** Gutters may be placed on all four walls of the pool. If end wall gutters are installed, they must allow for attachment of touch panels to the required 0.3 metre above the water surface. They must be covered with a suitable grill or screen.

### **16.2.6 Lanes**

#### **16.2.6.1 Number of lanes:**

Eight (8) lanes for the Olympic Games, although 9 or 10 lanes may be used with approval from the Chair of the Technical Swimming Committee when faced with unusual circumstances. [Example: a tie from preliminaries for 8th place in the 1500-metre freestyle].

Ten (10) lanes for World Aquatics Championships.

#### **16.2.6.2 Olympic Games**

Lanes shall be 2.5 metres wide with 2 spaces 2.5 metres wide outside of lanes 1 and 8. There must be a lane rope separating these spaces from lanes 1 and 8.

*See Swimming Diagram, Part Two, Annex 1*

#### **16.2.6.3 World Aquatics Championships**



For permanent swimming pools, lanes from 1 to 8 shall be 2.5 metres wide and lanes 0 and 9 shall be 2.4 metres wide with 2 spaces 0.1 metres wide outside of lanes 0 and 9. There must be a lane rope separating these spaces from lanes 0 and 9 for World Championships.

*See Diagrams Part Two, Annex 2 and 8*

For temporary swimming pools, lanes shall be 2.5 metres wide with 2 spaces 0.5 metres wide outside of lanes 0 and 9. There must be a lane rope separating these spaces from lanes 0 and 9.

*See Diagrams, Part Two, Annex 3 and 9*

## **16.2.7 Lane Ropes**

**16.2.7.1** The main function of a lane rope is not only to separate swimming lanes, but to reduce the pool waves. A lane rope should have the properties to reduce the waves going through to the other side of rope or bouncing back into the swimming lane.

Lane ropes shall extend the full length of the course, secured at each end wall to anchor brackets recessed into the end walls. The anchor shall be positioned so that the floats at each end wall of the pool shall be on the surface of the water. Each lane rope will consist of floats placed end-to-end having a minimum diameter of 0.15 metre.

Lane rope should be secured at each end wall to anchor brackets recessed into the end walls. If anchor placement is on pool deck, an extender, firm and non-elastic, should be in place.

The installed lane rope should stay in the pool water. The anchor, including extender, shall not extend more than 10mm into the pool. The anchor shall not influence the length of the lane rope by more than  $\pm 10$ mm each end of rope.

The anchor shall be positioned so that the wave reducing components at each end wall of the pool shall be 50% below the surface of the water. Anchors should be installed to withstand 20kN. Each lane rope will consist of wave reducing components placed end-to-end having a diameter of 0.15 metre. The design of discs and floats should be so that the floats, by themselves, do not influence the length of the lane rope. A float should be an integral part in between two discs. The lane rope length of the course shall have a negative buoyancy in such a way that at least one-half to maximum two-thirds of the height of the wave reducing components should be beneath the water surface.

The take-up reel of the lane rope should require a tool to lock tensioning into position and to prevent non-authorized tampering. The lane rope shall be equipped with a tension spring, absorbing sudden high point loads and a wire withstanding a tensile force of 12kN.

The components extending for a distance of 5.0 metres from each end of the pool shall be of RED colour.

There shall not be more than one lane rope between each lane. The lane ropes shall be firmly stretched and the tensions should be 1-1.2kN.

In a swimming pool, the colour of the lane ropes should be as follows:

### **16.2.7.1.1 Olympic Games**

In an eight (8) lane swimming pool the colour of the lane ropes should be as follows, although variations in the colour scheme can be used:

- Two (2) GREEN ropes for lanes 1 and 8
- Four (4) BLUE ropes for lanes 2, 3, 6 and 7
- Three (3) YELLOW ropes for lanes 4 and 5





		GREEN	
1		BLUE	
2		BLUE	
3		YELLOW	
4		YELLOW	
5		YELLOW	
6		BLUE	
7		BLUE	
8		GREEN	

**16.2.7.1.2 World Aquatic Championships**

In a ten (10) lane swimming pool the colour of the lane ropes should be as follows, although variations in the colour scheme can be used:

- Two (2) GREEN ropes for lanes 0 and 9
- Six (6) BLUE ropes for lanes 1, 2, 3, 6, 7 and 8
- Three (3) YELLOW ropes for lanes 4, 5

*See Swimming Diagrams, Part Two, Annex 2, 3, 8, and 9*

The floats extending for a distance of 5.0 metres from each end of the pool shall be of RED colour.

		GREEN	
0		BLUE	
1		BLUE	
2		BLUE	
3		BLUE	
4		YELLOW	
5		YELLOW	
6		YELLOW	
7		BLUE	
8		BLUE	
9		BLUE	
		GREEN	

**16.2.7.2** At the 15-metre mark from each end wall of the pool the components shall be distinct in colour from the surrounding components.

**16.2.7.3** In 50 metre pools the components shall be distinct to mark 25 metres.

**16.2.7.4** Lane numbers of soft material may be placed on the lane ropes at the start and turning end of the pool.

**16.2.7.5** Lane marking measurements, please read in conjunction with pool diagrams.

**16.2.8 Starting Platforms**

Starting Platforms shall be firm and give no springing effect. The height of the platform above the water surface shall be from 0.5 metre to 0.75 metre. The surface area shall be at least 0.5 metre x 0.6 metre and covered with a slip-resistant material.

Maximum slope shall not be more than 10 degrees. The starting platform may have an adjustable setting back plate. The platform shall be constructed so as to permit the gripping of the platform by the swimmer in the forward start at the front and the sides; it is recommended that, if the thickness of the starting platform exceeds 0.04 metre, grips of at least 0.1 metre width on each side and 0.4 metre width in the front be cut out to 0.03 metre from the surface of the platform.



Handgrips for the forward start may be installed on the sides of the starting platforms. Handgrips for backstroke starts shall be placed within 0.3 metre to 0.6 metre above the water surface both horizontally and vertically. They shall be parallel to the surface of the end wall and must not protrude beyond the end wall.

A minimum depth of 1.35 metres, extending from 1.0 metre to at least 6.0 metres from the end wall is required for pools with starting blocks. Electronic read-out boards may be installed under the blocks. Flashing is not allowed. Figures must not move during a backstroke start.

#### 16.2.9 Numbering

Each starting block must be distinctly numbered on all four sides, clearly visible. It is recommended that lane number 0 shall be on the right-hand side when facing the course from the starting end with exception of 50m events, which may start from the opposite end. Touch panels may be numbered on the top part.

#### 16.2.10 Backstroke turn indicators

Flagged ropes shall be suspended across the pool, 1.8 metres above the water surface, from fixed standards placed 5.0 metres from each end wall. Distinctive marks must be placed on both sides of the pool, and where possible on each lane rope, 15.0 metres from each end wall.

Flags must be fixed to the ropes having the following dimensions: 0.20 metres on the rope forming a triangle measuring 0.40 metres on the sides. The distance between each flag must be 0.25 metres. If the flags are printed with or support / carry any signage this must be approved in advance by World Aquatics.

#### 16.2.11 Backstroke Ledge

Backstroke ledges conforming to the specification set out below shall be used. **The ledge: (see diagram below)**

- shall be adjustable to 4 cm above or 4 cm below the water level and may not be used outside of this range;
- is a minimum of 60 cm in length;
- must be 8 cm in height, 2 cm at the width with 10 degrees of slope.

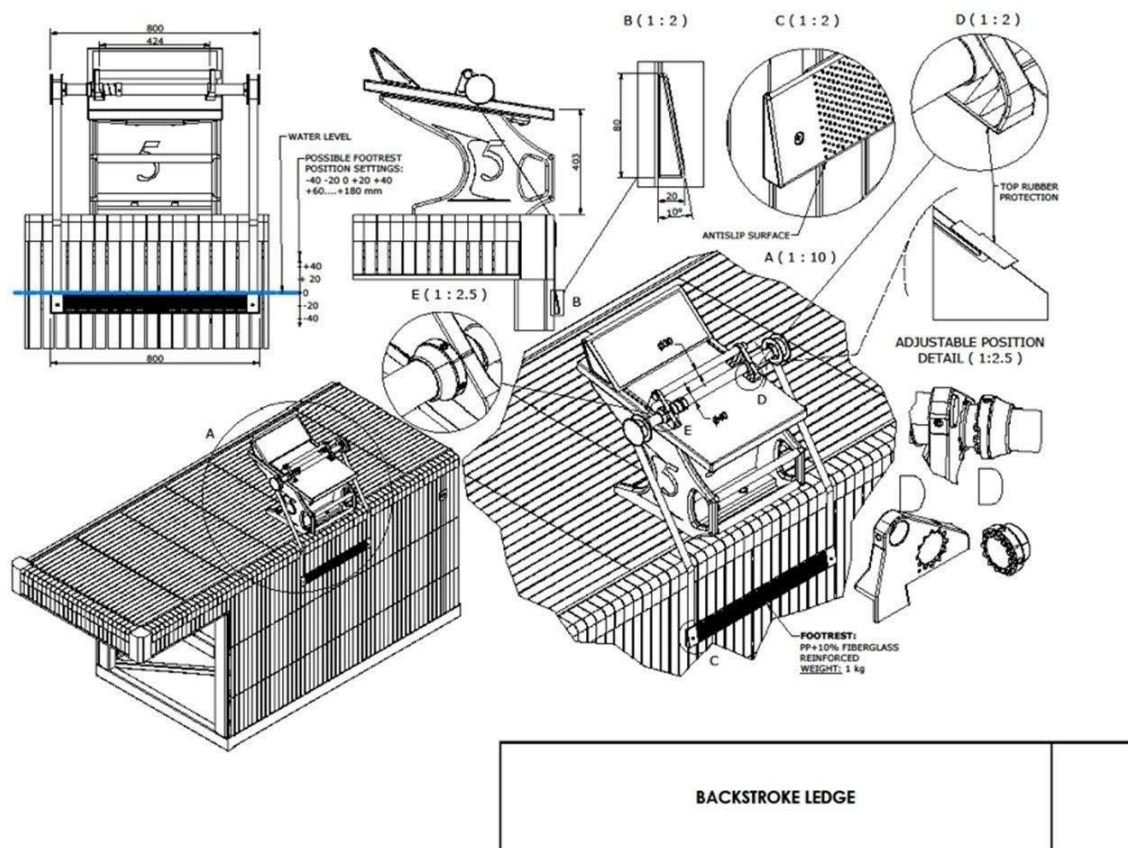

#### 16.2.12 False Start Rope



False Start Rope may be suspended across the pool not less than 1.2 metres above the water level from fixed standards placed 15.0 metres in front of the starting end. It shall be attached to the standards by a quick release mechanism. The rope must effectively cover all lanes when activated.

**16.2.13 Water conditions**

**16.2.13.1 Water Temperature**

Water temperature shall be 25°C to 28°C.

**16.2.13.2 Water Movement**

During competition, the water in the pool must be at a constant level, with no appreciable movement.

In order to keep the water level, preserve the transparency of water and take into consideration the health regulations in force in most countries, inflow and outflow has to be regulated as follows:

- 220 to 250 m<sup>3</sup>/h for 50.00 m pools
- 150 to 180 m<sup>3</sup>/h for 33.33 m pools
- 120 to 150 m<sup>3</sup>/h for 25.00 m pools

In daily use, inflow and outflow has to follow the health regulation of each country.

At these turnover rates, the water distribution has to be such that no appreciable current or turbulence is created.

“Appreciable current” is defined as water movement that can move a floating basketball (filled with 6 litres of water to obtain the right buoyancy) in one direction for more than 1,25m in 60 seconds.

The practical way to test this is to install two floating lines crosswise in a swim lane (to obtain a square with 2,5m size, ref. Image 1) and then to leave the basketball in the central point of the square. If the ball does not touch any of the four lane ropes within 60 seconds, the turbulence test is successful.

Test should be repeated in lanes 1,3,6,8 on two sides, at 5m from each end of the pool (end wall or bulkhead).



*Image 1*

**16.2.13.3 Salinity of the water**

World Records and World Junior Records can be established only in water with less than 3 gr/litre of salt.

No World Records will be recognized in any kind of sea or ocean water.

**16.2.14 Lighting**

Light intensity over the whole pool shall not be less than 1500 lux.

**16.2.15 Lane Markings**

Lane Markings shall be of a dark contrasting colour, placed on the floor of the pool in the centre of each lane.

**Width:** minimum 0.2 metre, maximum 0.3 metre.

**Length:** 46.0 metres for 50 metre long pools; 21.0 metres for 25 metre long pools.



Each lane line shall end 2.0\* metres from the end wall of the pool with a distinctive cross line 1.0 metre long and of the same width as the lane line. The distance between the centre points of each lane shall be 2.5 metres.

\*Pool length tolerances must be considered.

Target lines shall be placed on the end walls or on the touch panels, in the centre of each lane, of the same width as the lane lines. They shall extend without interruption from the deck edge (curb), to the floor of the pool to a maximum of 3 metres. A cross line 0.5 metre long shall be placed 0.3 metre below the water surface, measured to the centre point of the cross line.

For 50m and 25m pools constructed after 1st January 2006, cross lines 0.5 metre long shall be placed at the 15 metre mark from each end of the pool. After October 2013 this shall be measured from the end wall to the centre point of the cross line.

#### **16.2.16 Bulkheads**

When a bulkhead serves as an end wall, it must extend the full width of the course and present a solid smooth, non-slippery stable vertical surface on which touch pads may be mounted extending not less than 0.8m below and

0.3m above the surface of the water, and must be free of hazardous openings above or below the waterline which may be penetrated by a swimmer's hands, feet, toes or fingers. A bulkhead must be of a design that provides for the free movement of officials along its length without such movement creating any appreciable current or water turbulence.

#### **16.2.17 Minimum distance separating the pools**

If the swimming pool and the diving well are in the same area the minimum distance separating the pools shall be 5.0 metres. For pools constructed from 1st January 2014 the minimum distance separating the pool shall be a minimum of 8 metres however 10 metres is preferred.

### **16.3 Automatic officiating Equipment for Swimming**

#### **16.3.1 General description**

Automatic and Semi-Automatic Officiating Equipment records the elapsed time of each swimmer and determines the relative place in a race. Judging and timing shall be to 2 decimal places (1/100 of a second). Equipment that is installed shall not interfere with the swimmers' starts, turns, or the function of the overflow system.

#### **16.3.2 Equipment requirements**

The Equipment must:

**16.3.2.1** Be activated by the starter.

**16.3.2.2** Have no exposed wires on the pool deck, if possible.

**16.3.2.3** Be able to display all recorded information for each lane by place and by lane.

**16.3.2.4** Provide easy digital reading of a swimmer's time.

#### **16.3.3 Starting devices**

**16.3.3.1** The starter shall have a microphone for oral commands.

**16.3.3.2** If a pistol is used, it shall be used with a transducer.

**16.3.3.3** Both the microphone and the transducer shall be connected to loudspeakers at each starting block where both the starter's commands and the starting signal can be heard equally and simultaneously by each swimmer.

**16.3.3.4** False start detection equipment must be installed.

#### **16.3.4 Touch panels for Automatic Equipment**

**16.3.4.1** The minimum measurement of the touch panels shall be 2.4 metres wide and 0.9 metre high, and the thickness shall be 0.01m when the contact is closed (and the time is stopped).



They shall extend 0.3 metre above and 0.6 metre below the surface of the water. The equipment in each lane shall be electronically connected independently, so it may be controlled and maintained individually. The surface of the panels shall be of a bright colour and shall bear the line markings approved for the end walls.

**16.3.4.2** Installation - The touch panels shall be installed in a fixed position in the centre of the lanes. The panels may be portable, allowing the pool operator to remove them when there are no competitors.

**16.3.4.3** Sensitivity - The sensitivity of the panels shall be such that they cannot be activated by water turbulence, but will be activated by a light hand touch. The panels shall be sensitive on the top edge.

**16.3.4.4** Markings - The markings on the panels shall conform with and superimpose on the existing markings of the pool. The perimeter and edges of the panels shall be defined by a 0.025 metre black border.

**16.3.4.5** Safety - The panels shall be safe from the possibility of electrical shock and shall not have sharp edges.

**16.3.5 Semi-Automatic Equipment**

With Semi-Automatic Equipment, the finish shall be recorded by buttons pushed by timekeepers at the finish touch of the swimmer.

**16.3.5.1** Semi-Automatic Equipment may be used as a backup to the Automatic Officiating Equipment at World Aquatics or other major events if there are three buttons per lane, each operated by a separate official (in which case other finish judges shall not be required). An inspector of turns may operate one of the buttons.

**16.3.6 Automatic Equipment – Essential Accessories**

The following accessories are essential for a minimum installation of Automatic Equipment:

**16.3.6.1** Printout of all information, which can be regenerated during a succeeding race.

**16.3.6.2** Spectator readout board.

**16.3.6.3** Relay take-off judging to 1/100 of a second. Where overhead video cameras are installed they may be reviewed as a supplement to the automatic system's judgement of relay take-off. For the differential in the relays take-off the manufacturer of the device shall be consulted.

**16.3.6.4** Automatic lap counter.

**16.3.6.5** Readout of splits.

**16.3.6.6** Computer summaries.

**16.3.6.7** Correction of erroneous touch.

**16.3.6.8** Automatic rechargeable battery operation possibility.

**16.3.7 Automatic Equipment – Accessories for Olympic Games and World Aquatics Championships**

For Olympic Games and World Aquatics Championships the following accessories are also essential:

**16.3.7.1** The spectator electronic read-out board shall contain at least twelve (12) lines of thirty-two (32) characters, each capable of displaying both letters and numbers. Each character shall have a minimum height of 360 mm. Each line – matrix scoreboard shall be able to scroll up or down, with blink function, and each full matrix scoreboard shall be programmable, and capable of showing animation. The board must have a minimum size of 7.5 m width by 4.5m height.

**16.3.7.2** There shall be an air-conditioned control room, with dimensions of a least 6.0 metres x 3.0 metres, located between 3.0 metres and 5.0 metres from the finish wall, with an unobstructed view of the finish wall at all times during the race. The referee must have easy access to the control centre during the competition. At all other times the control room shall be able to be secured.

**16.3.7.3** Video judging and timing.

**16.3.8 Timing room**

Timekeepers shall have a clear view on the finish pool side from the Timing room. Sponsor panels or LED wall shall be installed at a minimum of 2m distance from the finish wall Timing room side. The panels or LED wall shall not exceed the length of 46m.



See Diagram

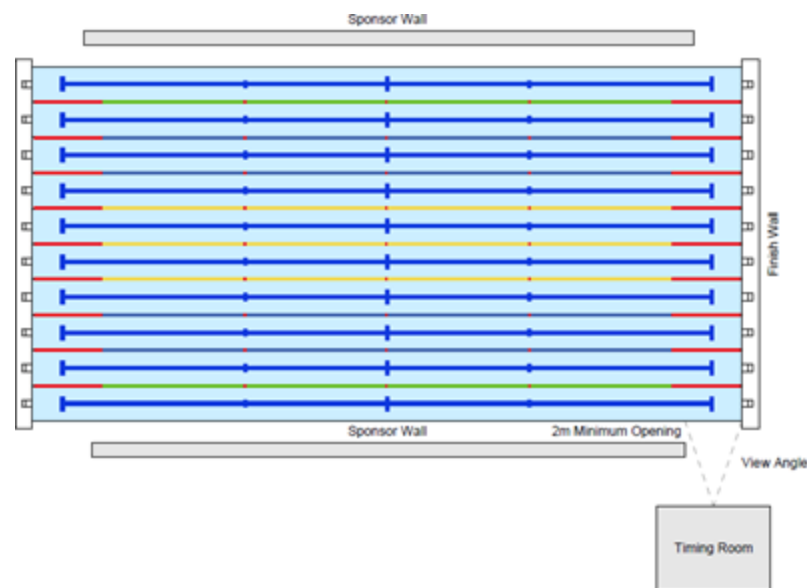

#### 16.3.9 Video Judging Equipment

At Olympic Games and World Championships approved Automatic Officiating Equipment, including Video Judging Equipment shall be provided and used. The approved Video Judging Equipment shall be used to initiate stroke infraction calls, confirm stroke infraction calls or assist the Referee to overturn calls made on the pool deck.

## 17 MEDICAL AND SAFETY SPECIFIC REQUIREMENTS FOR SWIMMING

The Medical Requirements are described in the Part One, Article 9.2. However, each sport has unique components.

#### 17.1 Pre-competition trainings

Swimming competitions are generally composed of two competition sessions: one in the morning and one in the afternoon/evening. Prior to the races, the swimmers will be present at the venue to train. They generally arrive 2.5 - 3 hours before the beginning of the competition. It implies that an important number of athletes are swimming but also walking around the pool, and exercising/stretching. This proximity can lead to collisions in and out of the water.

Pre-competition training is a critical period as numerous swimmers in the pool are training at the same time and are practising various elements of their race (e.g the start) or are swimming different strokes. While lanes are dedicated to each practice, accident/collision can occur.

In addition, at major events, the numbers of swimmers in the warm-up pool area could be particularly high. The numbers of lifeguards shall therefore be adjusted to appropriately cover the different swimming pools.

#### 17.2 Location of the FoP First Aid Treatment Area

Ideally, for the competition pool, the Field of Play (FoP) First Aid Treatment Area should be positioned where the athletes exit the water without obstructing the mixed zone on the pool deck.

#### 17.3 Water Rescue and Lifeguards

Lifeguards should practice water retrieval on a daily basis during the event. In Swimming, it is important to remember that the swimming pools are separated by the lane ropes that could block the access to the swimmer during the water rescue. This point must be taken into consideration while practising and the extraction point should be adjusted.

It is recommended to have three (3) lifeguards by swimming-pool. Two lifeguards next to the FoP Treatment area and a third lifeguard positioned on the opposite side.

**18 APPENDICES**

- 18.1 APPENDIX 1 - DIAGRAM SWIMMING POOL 50x25m – 8 Lane
- 18.2 APPENDIX 2 - DIAGRAM SWIMMING POOL 50X25m – 10 Lanes
- 18.3 APPENDIX 3 - DIAGRAM SWIMMING POOL 50X25m – 10 Lanes
- 18.4 APPENDIX 4 - DIAGRAM SWIMMING POOL 50X25 WITH ONE BULKHEAD IN LATERAL POSITION
- 18.5 APPENDIX 5 - DIAGRAM SWIMMING POOL 50X25M WITH ONE BULKHEAD –BULKHEAD IN CENTRAL POSITION
- 18.6 APPENDIX 6 - DIAGRAM SWIMMING POOL 25X21M – 8 Lanes
- 18.7 APPENDIX 7 - DIAGRAM SWIMMING POOL 25X21M – 8 Lanes
- 18.8 APPENDIX 8 - DIAGRAM SWIMMING POOL 25X25M – 10 Lanes
- 18.9 APPENDIX 9 - DIAGRAM SWIMMING POOL 25X26M – 10 Lanes
- 18.10 APPENDIX 10 - DIAGRAM 50m SWIMMING POOL – Lane markings



**18.1 APPENDIX 1 - DIAGRAM SWIMMING POOL 50x25m - 8 Lane**

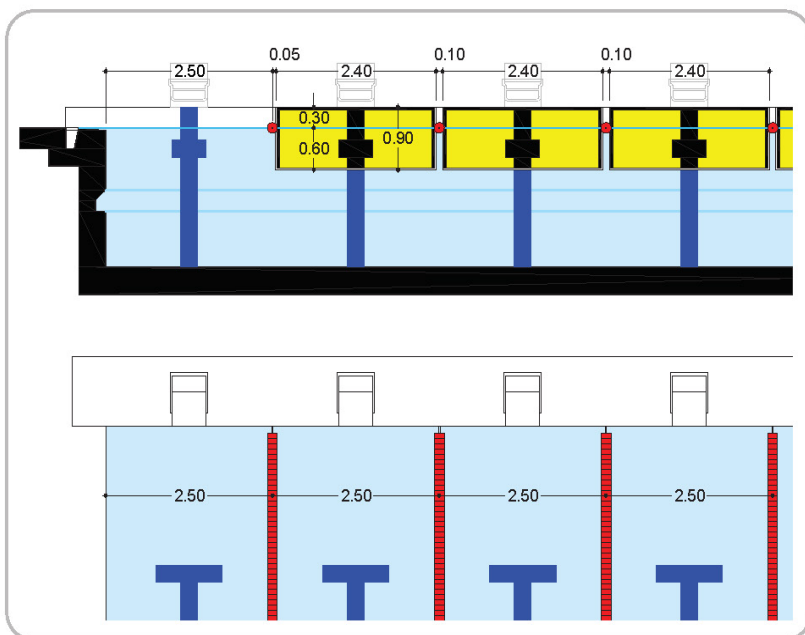
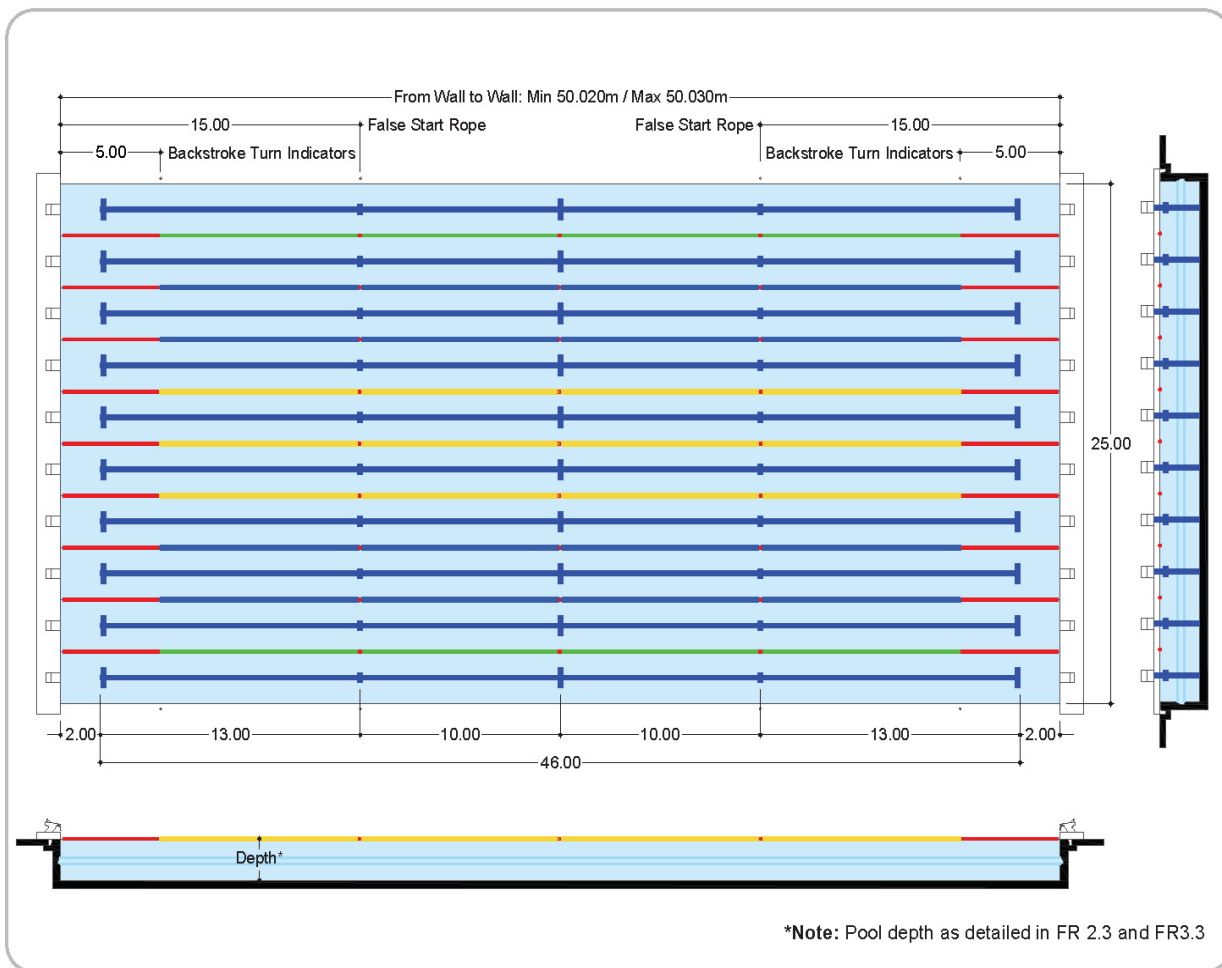

**Lane Ropes**

In a 8 (eight) lanes swimming pool the colour of the lane ropes should be as follows:

- Two (2) GREEN ropes for lanes 1 and 8.
- Four (4) BLUE ropes for lanes 2, 3, 6 and 7.
- Three (3) YELLOW ropes for lanes 4, 5.





**18.2 APPENDIX 2 - DIAGRAM SWIMMING POOL 50X25m – 10 Lanes**

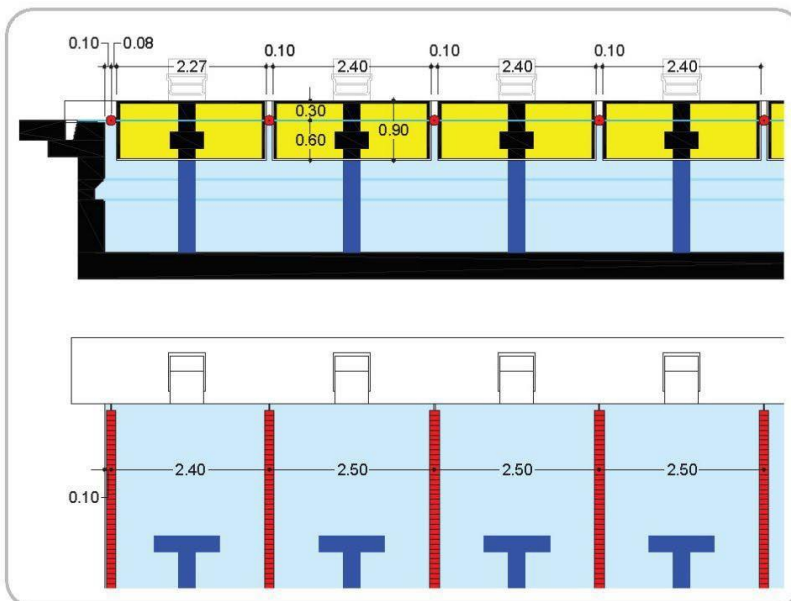
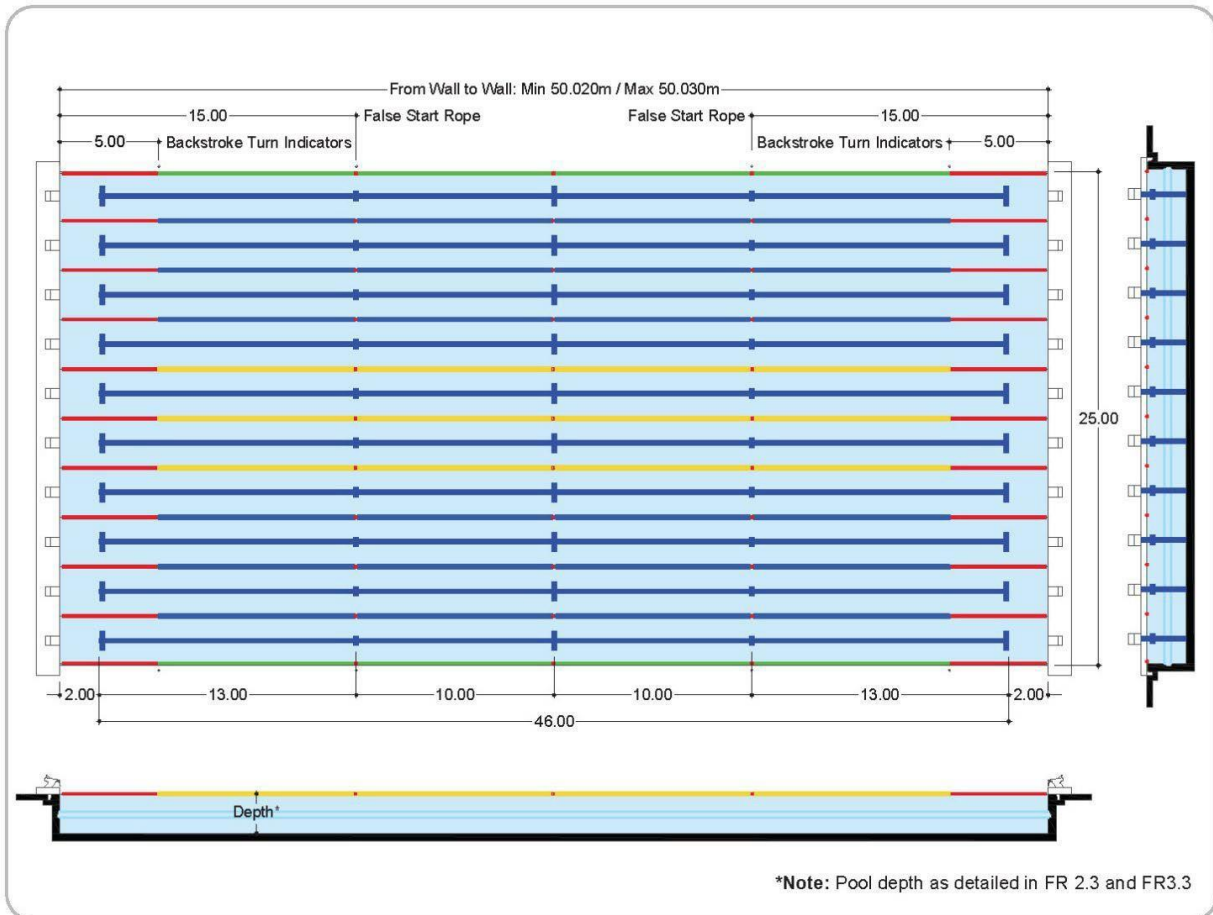

**Lane Ropes**

In a 10 (ten) lanes swimming pool the colour of the lane ropes should be as follows:

- Two (2) GREEN ropes for lanes 0 and 9.
- Six (6) BLUE ropes for lanes 1, 2, 3, 6, 7 and 8.
- Three (3) YELLOW ropes for lanes 4, 5.



**18.3 APPENDIX 3 - DIAGRAM SWIMMING POOL 50X25m – 10 Lanes**

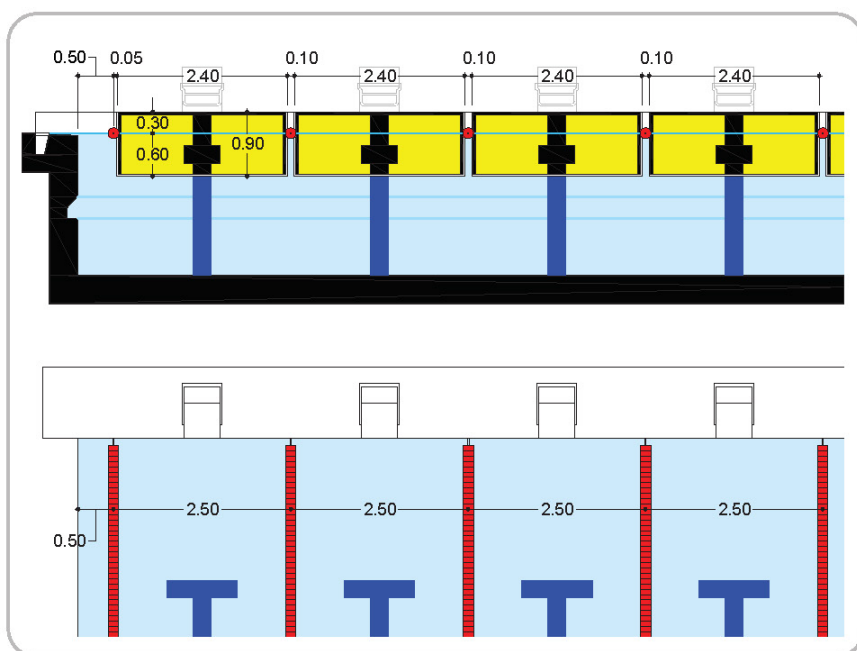
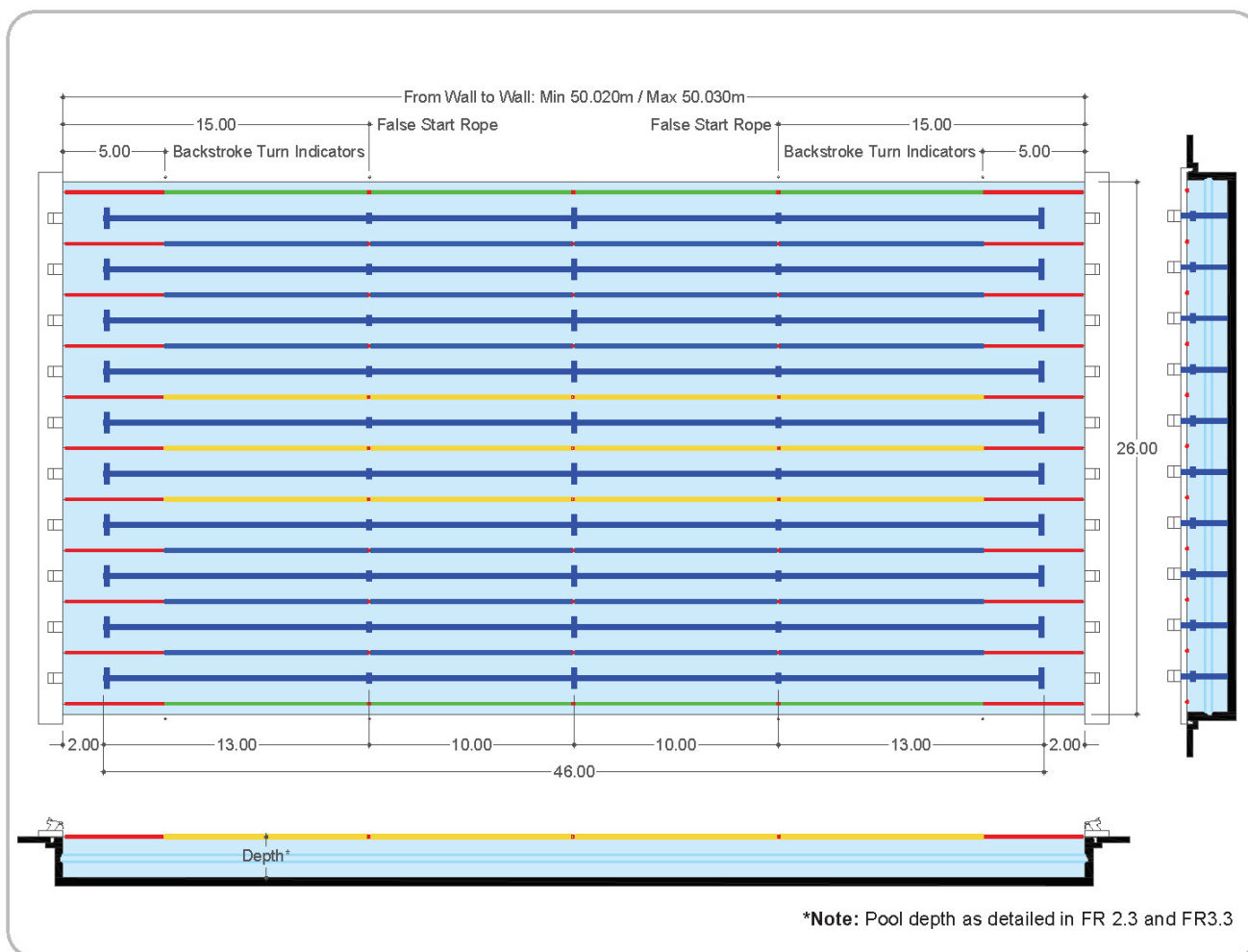

**Lane Ropes**

In a 10 (ten) lanes swimming pool the colour of the lane ropes should be as follows:

- Two (2) GREEN ropes for lanes 0 and 9.
- Six (6) BLUE ropes for lanes 1, 2, 3, 6, 7 and 8.
- Three (3) YELLOW ropes for lanes 4, 5.



**18.4 APPENDIX 4 - DIAGRAM SWIMMING POOL 50X25 WITH ONE BULKHEAD IN LATERAL POSITION**

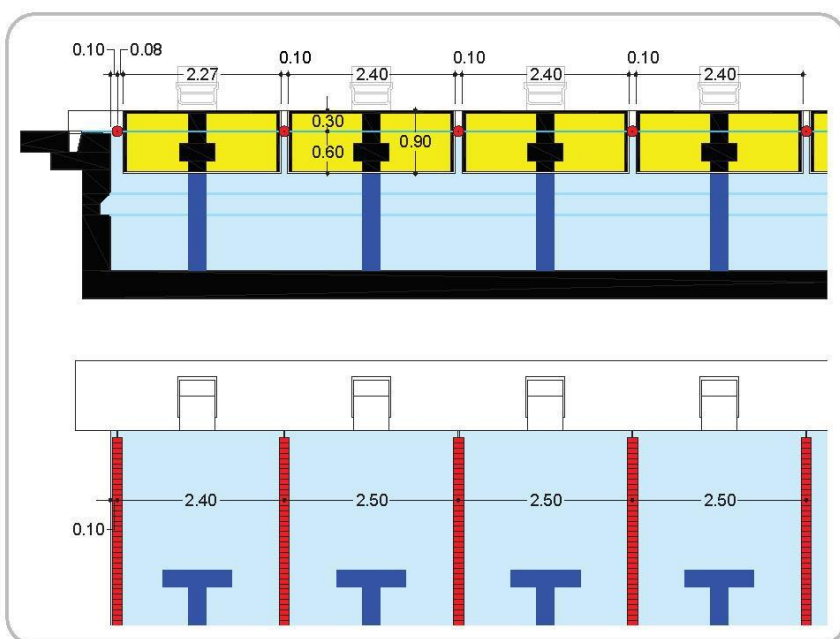
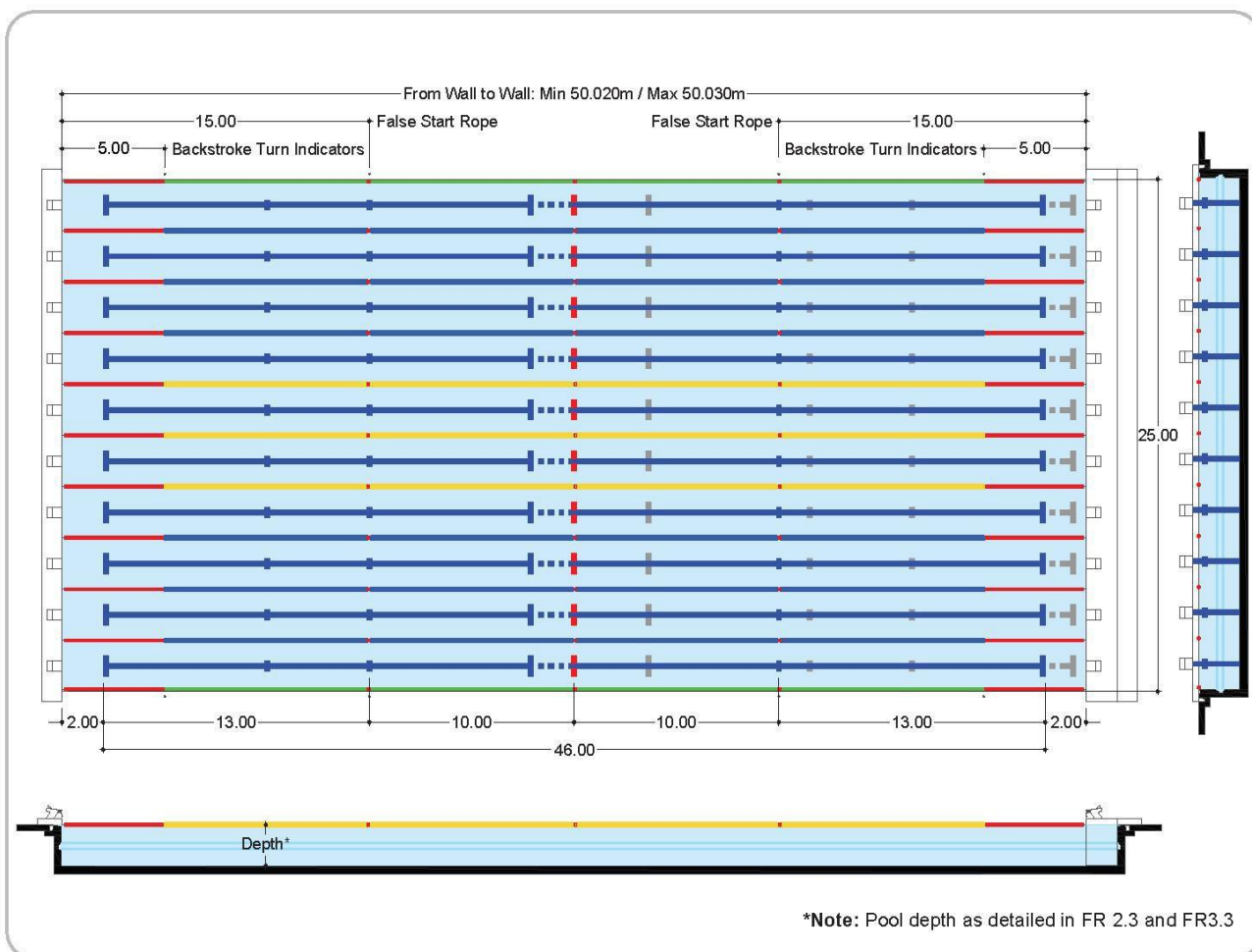

**Lane Ropes**

In a 10 (ten) lanes swimming pool the colour of the lane ropes should be as follows:

- Two (2) GREEN ropes for lanes 0 and 9.
- Six (6) BLUE ropes for lanes 1, 2, 3, 6, 7 and 8.
- Three (3) YELLOW ropes for lanes 4, 5.



**18.5 APPENDIX 5 – DIAGRAM SWIMMING POOL 50X25M WITH ONE BULKHEAD – BULKHEAD IN CENTRAL POSITION**

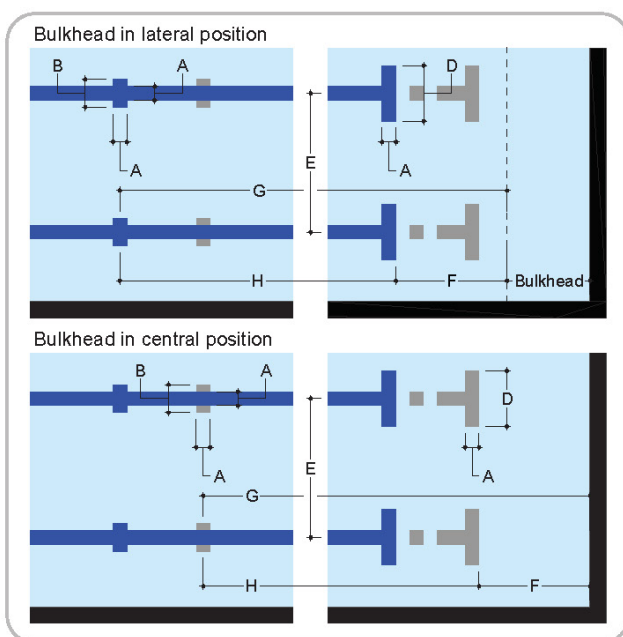
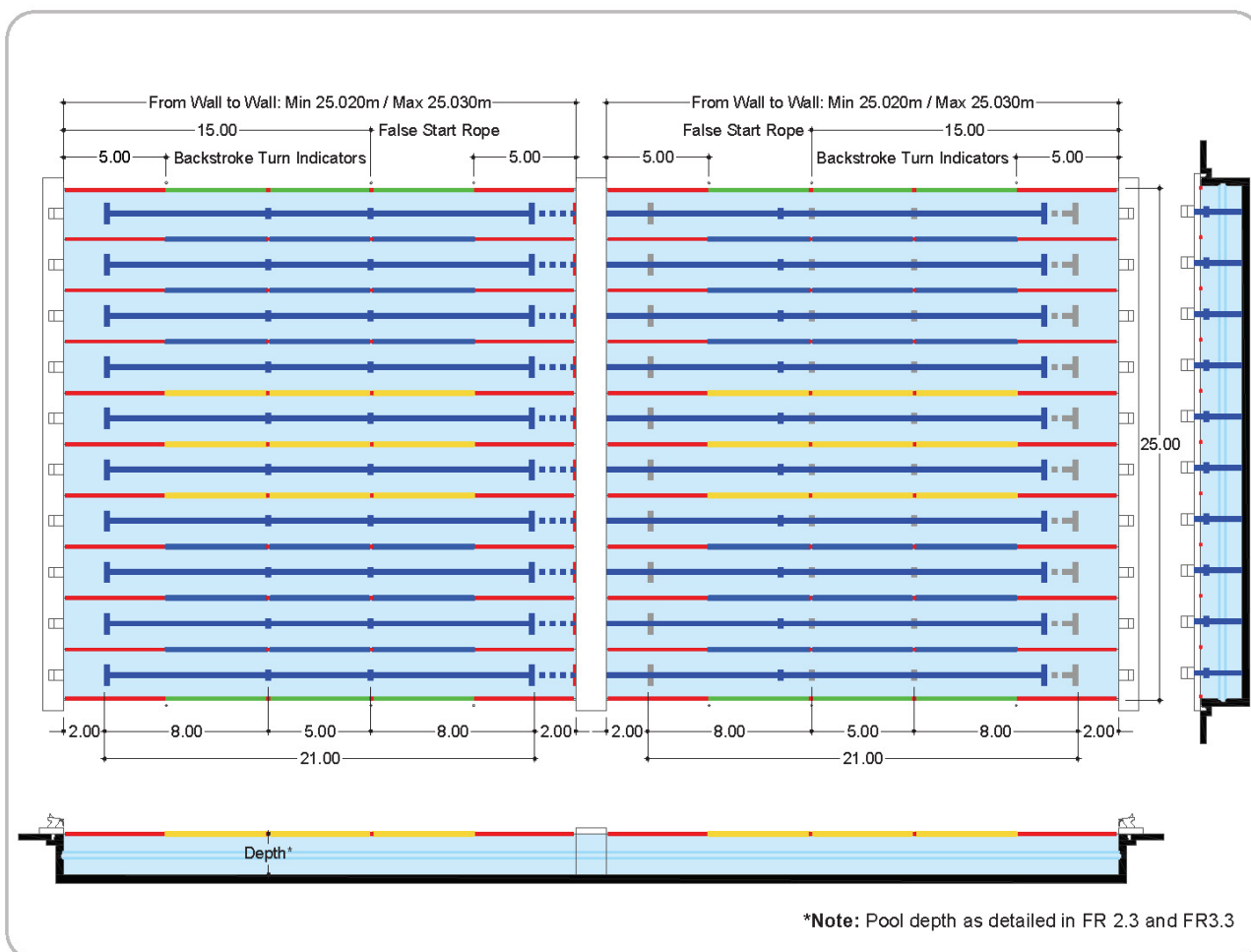

**Lane Markings**

Width of lane markings, end, lines targets	A	0.25m ± 0.05m
Length of end wall targets	B	0.50m
Depth to centre of end wall targets	C	0.30m
Length of lane marker cross line	D	1.00m
Width of racing lanes	E	2.50m
Distance from end of lane line to end wall	F	2.00m*
Distance from centre of cross line to end wall	G	15.00m*
Distance from end of lane line to centre of cross line	H	13.00m
Distance from centre of cross line to end wall	I	25.00m*

*\* Pool tolerance has to be considered*



**18.6 APPENDIX 6 - DIAGRAM SWIMMING POOL 25X21M – 8 Lanes**

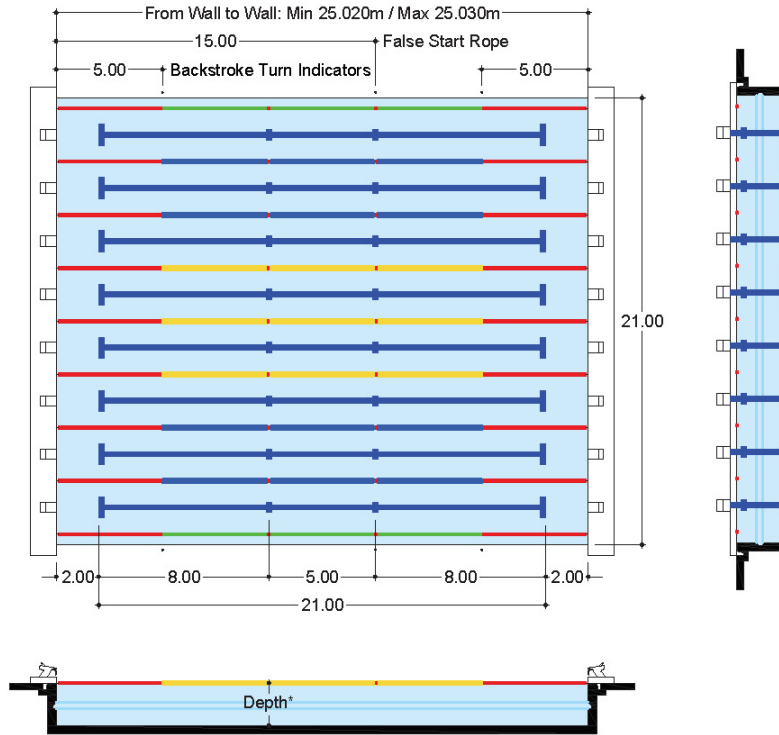

**\*Note:** Pool depth as detailed in FR 2.3 and FR3.3

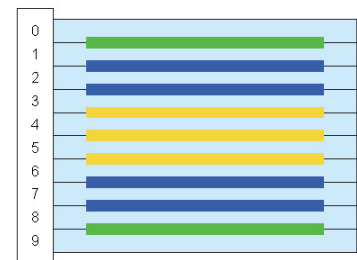
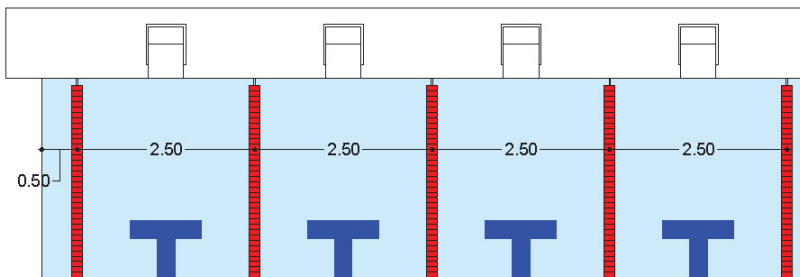
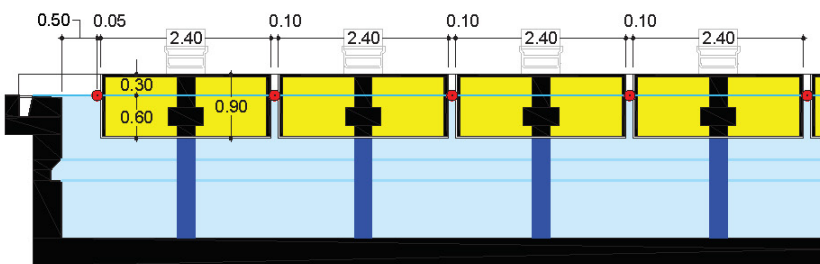

**Lane Ropes**

In a 8 (eight) lanes swimming pool the colour of the lane ropes should be as follows:

- Two (2) GREEN ropes for lanes 1 and 8.
- Four (4) BLUE ropes for lanes 2, 3, 6 and 7.
- Three (3) YELLOW ropes for lanes 4, 5.



**18.7 APPENDIX 7 - DIAGRAM SWIMMING POOL 25X21M – 8 Lanes**

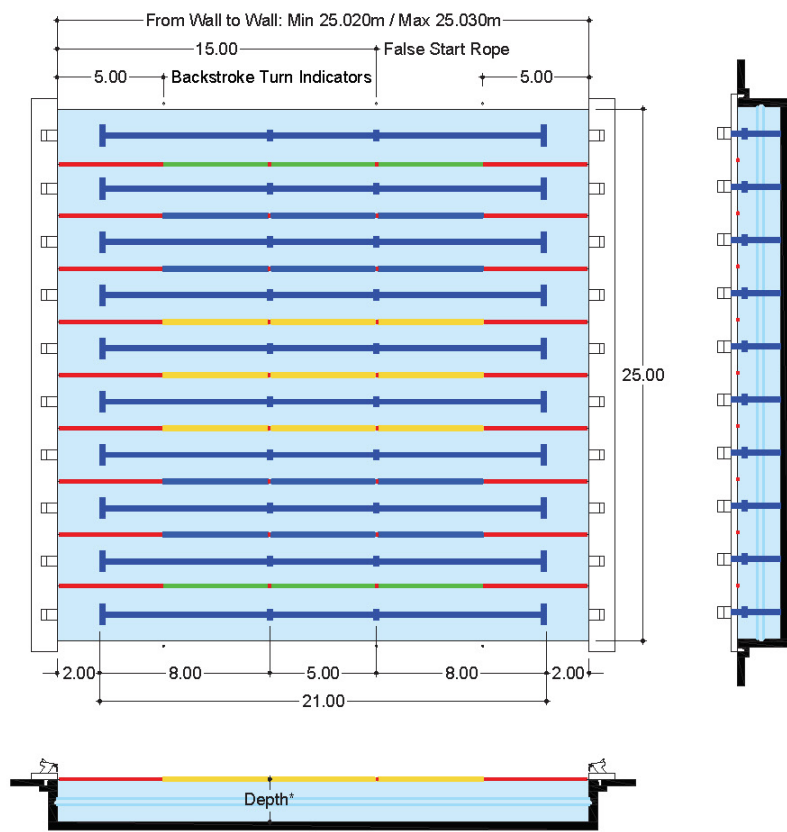

\*Note: Pool depth as detailed in FR 2.3 and FR3.3

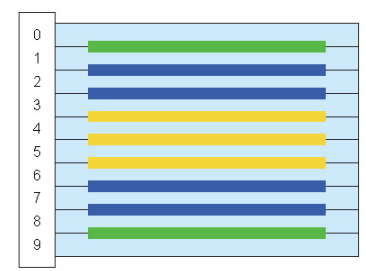
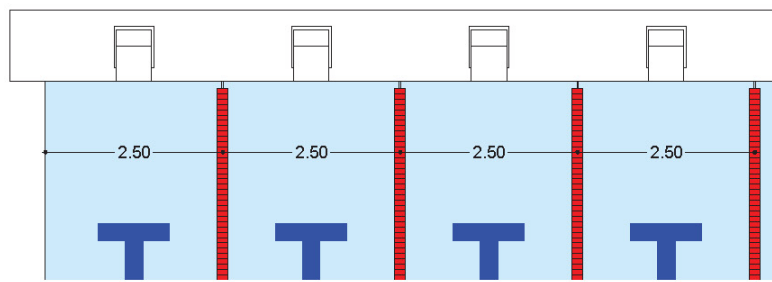
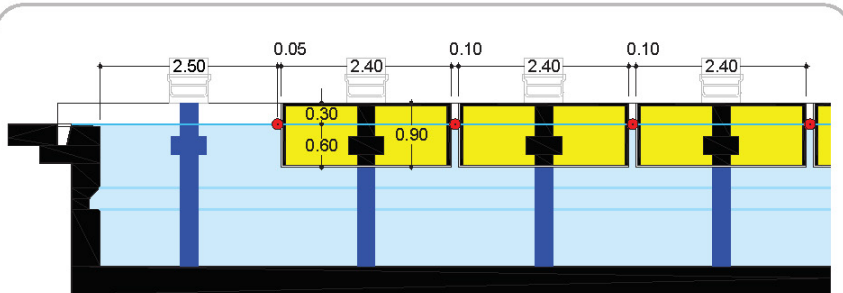

**Lane Ropes**

In a 8 (eight) lanes swimming pool the colour of the lane ropes should be as follows:

- Two (2) GREEN ropes for lanes 1 and 8.
- Four (4) BLUE ropes for lanes 2, 3, 6 and 7.
- Three (3) YELLOW ropes for lanes 4, 5.



18.8 APPENDIX 8 - DIAGRAM SWIMMING POOL 25X25M – 10 Lanes

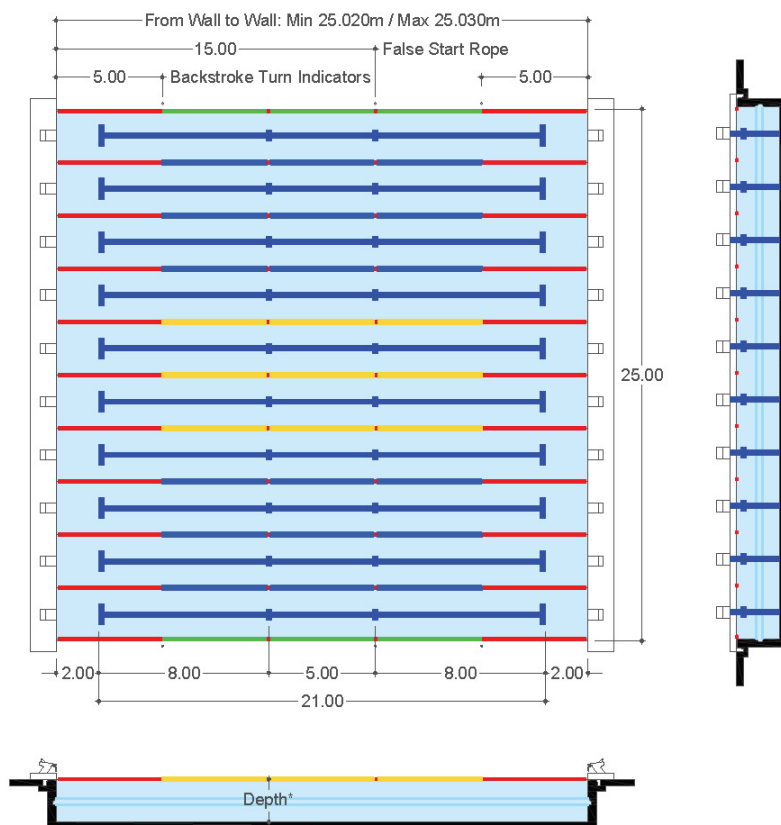

\*Note: Pool depth as detailed in FR 2.3 and FR3.3

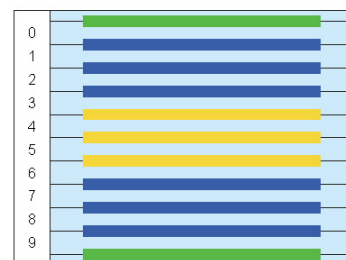
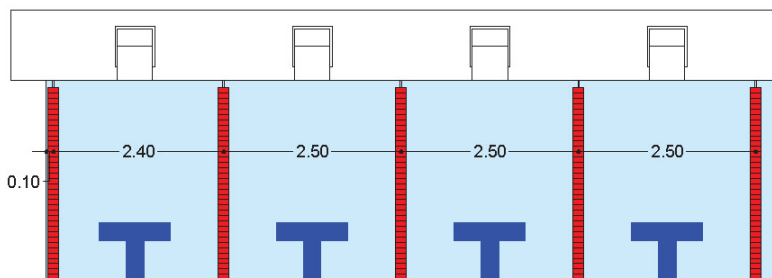
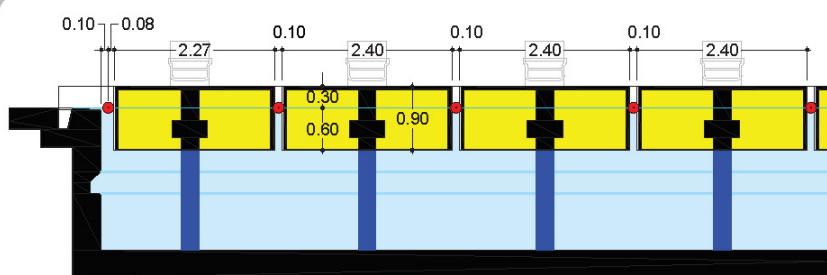

**Lane Ropes**

In a 10 (ten) lanes swimming pool the colour of the lane ropes should be as follows:

- Two (2) GREEN ropes for lanes 0 and 9.
- Six (6) BLUE ropes for lanes 1, 2, 3, 6, 7 and 8.
- Three (3) YELLOW ropes for lanes 4, 5.



**18.9 APPENDIX 9 - DIAGRAM SWIMMING POOL 25X26M – 10 Lanes**

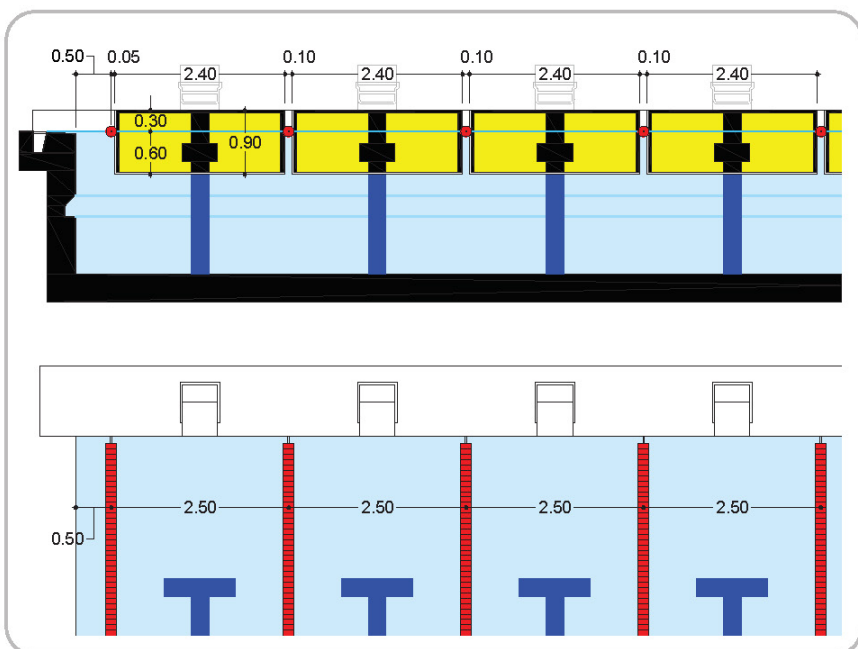
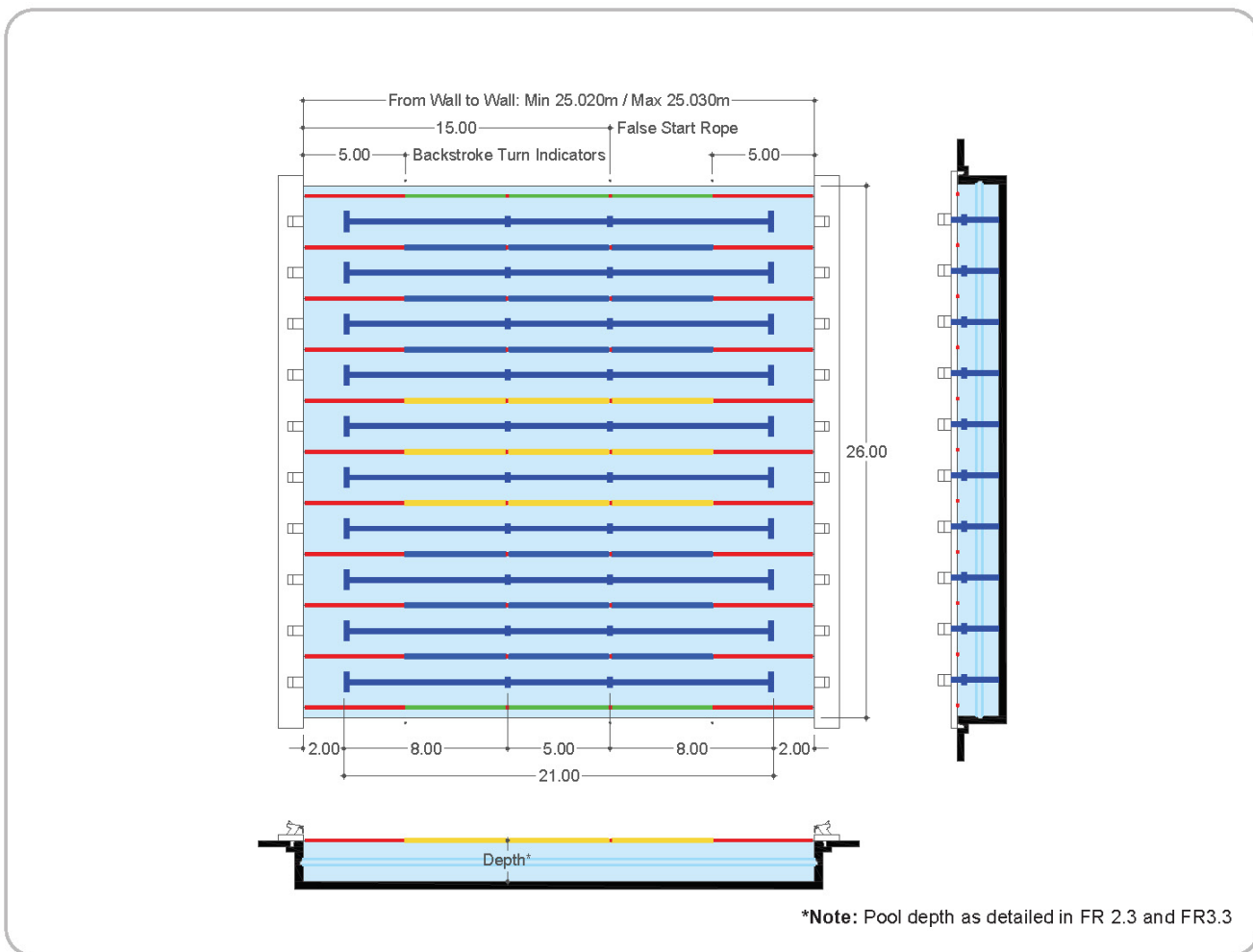

**Lane Ropes**

In a 10 (ten) lanes swimming pool the colour of the lane ropes should be as follows:

- Two (2) GREEN ropes for lanes 0 and 9.
- Six (6) BLUE ropes for lanes 1, 2, 3, 6, 7 and 8.
- Three (3) YELLOW ropes for lanes 4, 5.



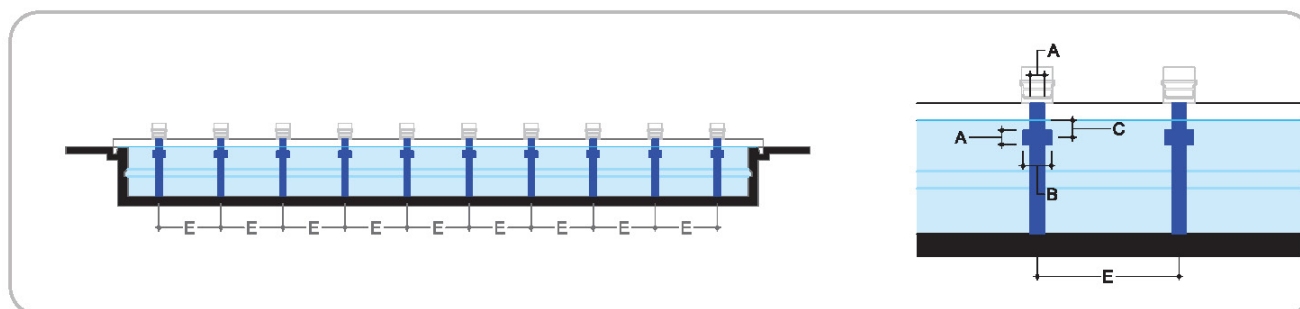
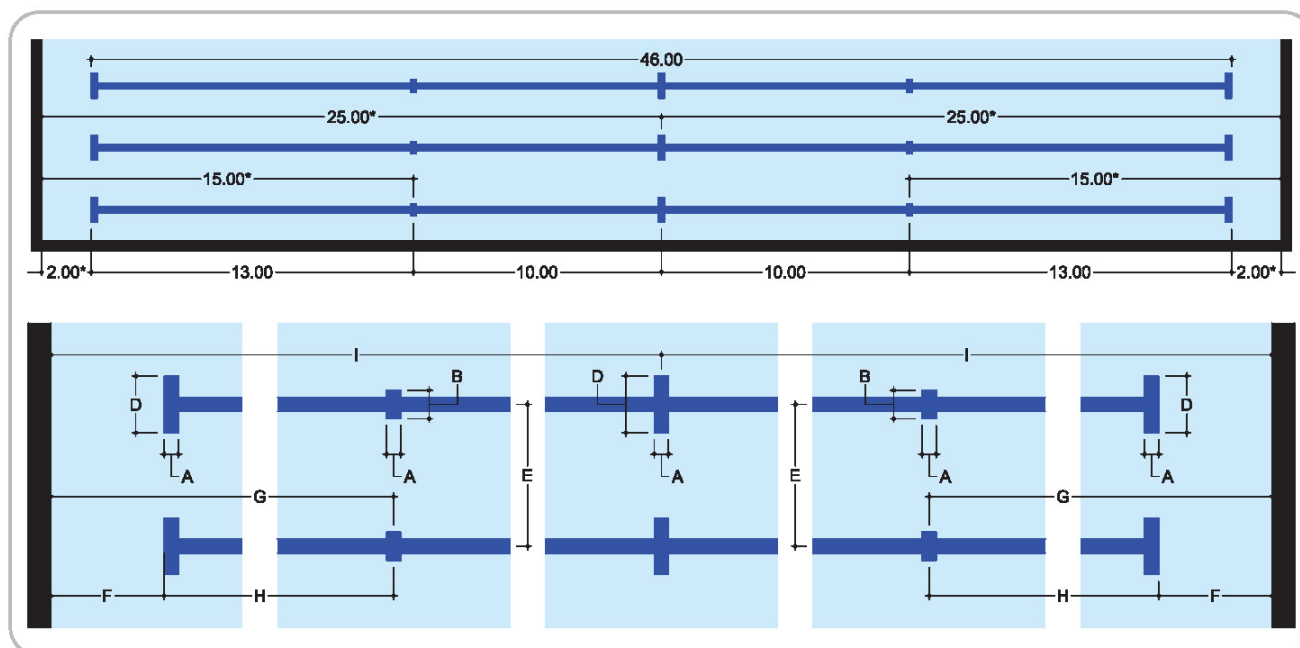

**18.10 APPENDIX 10 - DIAGRAM 50m SWIMMING POOL – Lane markings**

**Lane Markings**

Width of lane markings, end, lines targets	A	0.25m ± 0.05m
Length of end wall targets	B	0.50m
Depth to centre of end wall targets	C	0.30m
Length of lane marker cross line	D	1.00m
Width of racing lanes	E	2.50m
Distance from end of lane line to end wall	F*	2.00m*
Distance from centre of cross line to end wall	G	15.00m*
Distance from end of lane line to centre of cross line	H	13.00m
Distance from centre of cross line to end wall	I	25.00m*

\* Pool tolerance has to be considered

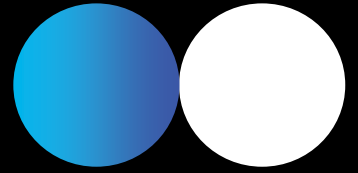

WORLD  
AQUATICS



# OPEN WATER SWIMMING

COMPETITION  
REGULATIONS

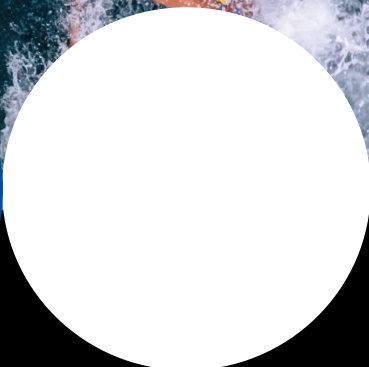
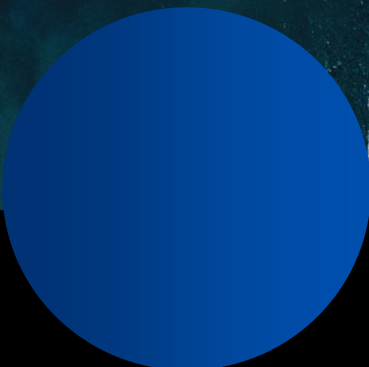



## TABLE OF CONTENTS

### PART THREE: OPEN WATER SWIMMING RULES

<b>PART THREE: OPEN WATER SWIMMING RULES</b> .....	<b>108</b>
<b>1</b> WORLD AQUATICS CHAMPIONSHIPS AND OLYMPIC GAMES .....	<b>108</b>
<b>2</b> OFFICIALS .....	<b>109</b>
<b>3</b> DUTIES OF OFFICIALS .....	<b>110</b>
<b>4</b> THE START .....	<b>113</b>
<b>5</b> THE RACE .....	<b>114</b>
<b>6</b> THE FINISH OF THE RACE .....	<b>115</b>
<b>7</b> SWIMWEAR & TECHNOLOGY.....	<b>116</b>
<b>8</b> IDENTIFICATION OF COMPETITORS DURING THE RACE .....	<b>116</b>
<b>9</b> OPEN WATER SWIMMING FACILITIES AND EQUIPMENT .....	<b>116</b>
<b>10</b> WATER QUALITY GUIDELINES FOR OPEN WATER .....	<b>118</b>
<b>11</b> OPEN WATER SAFETY REGULATIONS .....	<b>123</b>
<b>12</b> APPENDICES.....	<b>127</b>
12.1 APPENDIX 1 - Diagram – Field of Play .....	128
12.2 APPENDIX 2 - Diagram – Crafts Position .....	129
12.3 APPENDIX 3 - Diagram – Platforms and Buoys .....	130
12.4 APPENDIX 4 - Diagram – Gates .....	131
12.5 APPENDIX 5 - Diagram – Gates – Decision Review System (DRS).....	132
12.6 APPENDIX 6 – DIAGRAM – TIMING ROOM .....	133



## PART THREE: OPEN WATER SWIMMING RULES

### 1 WORLD AQUATICS CHAMPIONSHIPS AND OLYMPIC GAMES

**1.1** Open Water Swimming is defined as any competition that takes place in rivers, lakes, oceans or water channels or any other body of open water.

#### 1.2 Program of the Olympic Games

Men	Women
10 kilometres	10 kilometres

#### 1.3 Program of the World Aquatics Championships

Men	Women	Mixed Team Event
10 kilometres	10 kilometres	N/A
5 kilometres	5 kilometres	N/A
		4x1500 m Relay
*3km Knockout Sprint	*3km Knockout Sprint	

\*3km Knockout Sprint event may be included in the World Aquatics Championships Programme subject to agreement between World Aquatics and the Organising Committee.

##### 1.3.1 Description of the Mixed Team Race

- Two (2) female and two (2) male competitors from the same country
- Each competitor shall complete a lap of 1.5 km.
- competitors may swim in any sequence, but may only swim once.
- All teams will start together.
- Starting order on the platform will be by random draw.
- There shall be a change-over zone of a minimum of 5 m in length of sufficient size for the teams competing.
- Changeovers shall be made with the following competitor in the water in their starting position holding the platform, except where a relay change platform is used.
- Contact on the relay changeover must be visible. The touch, between the competitors making the changeover, should be made above the water anywhere between the elbow and the hand when the changeover is in the water. Where a relay change platform is used, the following competitor may start with a dive from the opposite side of the platform immediately after the arriving competitor touches the platform.
- Competitors may enter the change-over zone when the previous competitor is approaching the zone and leave the water immediately at the conclusion of their lap.
- Departing competitors must dive from the start position allocated to their team.
- All competitors from the same team shall all wear the same team caps of the same colour and style, in accordance with Part One, Article 8.6 of the World Aquatics Competition Regulations.
- Relay Changeover platforms shall be used for all World Aquatics events.

##### 1.3.2 Description of the 3km Knockout Sprint Race:

- Male and Female races will be swum separately.
- Each Federation may enter a maximum of two (2) Male, and two (2) female competitors.
- For Round one (1) the entry list will be published in advance of the Team Leaders Meeting. - The number of heats to be swum in Rounds one (1) and two (2) will be determined after all the entries have been received and processed and will be announced at the Team Leaders Meeting. For Round two (2) the maximum number of heats would be two (2). - Random draw for heats will be published in advance of Registrations opening.
- In Round One (1) each competitor will swim 1500m, competitors advancing to Round two (2) will swim 1000m, and competitors advancing to Round three (3) will swim 500m.



5. The top ten (10) finishes from each heat in Round one (1) will advance to Round two (2) or two (2) heats with the allocation process announced at the Team Leaders Meeting.
6. If there is one (1) heat in Round two (2) the top 10 from Round two (2) will advance to the Round three (3) final. If there are two (2) heats in Round two (2) the top 10 finishes from each heat will advance to the Round three (3) final.
7. If any competitor receives a 1st infringement during Rounds one (1) or two (2) then this penalty would remain in place if the competitor advances forward in any Rounds of the event.
8. In the event of disqualification or withdrawal from Rounds two (2) or three (3) the position competitor would have had shall be awarded to the competitor who finished next, and all the lower placing competitors shall be advanced one place in the semi-final (s) or final.
9. Medals will be awarded for 1st, 2nd and 3rd places for each gender Male (M) and Female (F) as per Part One, Article.12.1.2.1.

**1.4** The **minimum age** for swimmers competing in the Olympic Games and World Aquatics Championships shall be the same as the minimum age for the World Aquatics Junior Open Water Swimming Championships: Girls and Boys, at least 14 years of age, on 31st December in the year of competition.

**1.5 World Aquatics Junior Open Water Swimming Championships**

**1.5.1 Age Groups**

The Age Groups as of 31st December of the year of the competition are:

- 14-15 years Boys and Girls
- 16-17 years Boys and Girls
- 18-19 years Boys and Girls

**1.5.2 Individual Events**

- 14-15 years 5 km Boys and Girls
- 16-17 years 7.5 km Boys and Girls
- 18-19 years 10 km Boys and Girls
- \*Open 3km Knockout Sprint Boys and Girls

\* Open 3km Knockout Sprint event shall be included in the World Aquatics Championships Programme subject to agreement between World Aquatics and the Organising Committee.

**1.5.3 Mixed Team Relays**

**1.5.3.1 The distance**

Mixed 4 x 1500m

**1.5.3.2 Description of the Race**

As per Part Three, Article 1.3.1

**1.5.4 Competition Program Proposal**

	<b>Day 1</b>	<b>Day 2</b>	<b>Day 3</b>
<b>Morning</b>	14-15 years 5 km	18-19 years 10 km	14-16 years Relay Event
<b>Afternoon</b>	16-17 years 7.5 km	Open 3km Knockout Sprint	Open Relay Event

**2 OFFICIALS**

The following officials shall be appointed at Open Water Swimming competitions:

- Chief Referee (one per race)
- Referees (2 minimum, additional Referees proportional to race entries)
- Chief Timekeeper plus 2 Timekeepers
- Chief Finish Judge plus 2 Finish Judges
- Safety Officer
- Medical Officer
- Course Officer



- Clerk of the Course
- Race Judges (one per competitor) except for events with a course of 10 km or less
- Turn Judges (one per alteration of Course)
- Feeding Platform Judge (when feeding platforms are used)
- Relay Judge
- Starter
- Announcer
- Recorder
- Video Review Judge

*NOTE: No official can act in more than one role simultaneously. They may only undertake a new role after all of the obligations of their previous role have been fulfilled.*

### **3 DUTIES OF OFFICIALS**

#### **3.1 Chief Referee**

The Chief Referee shall:

- 3.1.1** have full control and authority over all officials and shall approve their assignments and instruct them regarding all special features or regulations related to the competition. The Chief Referee shall enforce all the Rules and decisions of World Aquatics and shall decide all questions relating to the actual conduct of the competition, the final settlement of which is not otherwise covered by these Rules.
- 3.1.2** ensure that all necessary officials for the conduct of the competition are at their respective posts. The Chief Referee may appoint substitutes for any who are absent, incapable of acting or found to be inefficient and may appoint additional officials if considered necessary.
- 3.1.3** have authority to intervene in the competition at any stage to ensure that World Aquatics Rules are observed.
- 3.1.3.1** In case of hazardous conditions that jeopardize the safety of the competitors and the officials, in conjunction with the Safety Officer she/he can stop the race.
- 3.1.4** adjudicate on all protests related to the competition in progress.
- 3.1.5** signal to competitors, by raised flag and short blasts on a whistle, that the start is imminent and when satisfied indicate by pointing the flag at the Starter that the competition may commence.
- 3.1.6** disqualify any competitor for any violation of the Rules that she/he personally observes, or which is reported to her/him by other authorised officials. Notwithstanding the provisions of Part Three, Article 5.3 hereof, the Chief Referee may decide to enforce the disqualification at the end of the race.
- 3.1.7** receive all reports prior to the start of the race and at the conclusion of the race from the Clerk of the Course, Recorder, Course Officer and Safety Officer to ensure all competitors are accounted for.
- 3.1.8** give a decision in cases where the Finish Judges' decisions and times recorded do not agree.

#### **3.2 Referees**

The Referees shall:

- 3.2.1** have authority to intervene in competition at any stage to ensure that World Aquatics Rules are observed.
- 3.2.2** disqualify any competitor for any violation of the Rules that they personally observe.

#### **3.3 Starter**

- 3.3.1** The Starter shall start the race in accordance with Part Three, Article 4 following the signal by the Chief Referee.

#### **3.4 Chief Timekeeper**

The Chief Timekeeper shall:

- 3.4.1** assign at least two (2) Timekeepers to their positions for the start and finish.



**3.4.2** ensure that a time check is made to allow all persons to synchronise their watches with the official running clocks 15 minutes before start time.

**3.4.3** collect from each Timekeeper the time recorded for each competitor, and, if necessary, inspect their watches.

**3.4.4** record or examine the official time for each competitor.

### **3.5 Timekeepers**

Timekeepers shall:

**3.5.1** take the time of each competitor/s assigned. The watches must have memory and printout capability and shall be certified correct to the satisfaction of the Management Committee.

**3.5.2** start their watches at the starting signal, and only stop their watches when instructed by the Chief Timekeeper.

**3.5.3** promptly after each finish record the time of each competitor and turn it over to the Chief Timekeeper.

*NOTE: When Automatic Officiating Equipment is used, the same complement of hand timers is to be used.*

### **3.6 Chief Finish Judge**

The Chief Finish Judge shall:

**3.6.1** assign each Judge to a position.

**3.6.2** record and communicate any decision received from the Referees during the competition.

**3.6.3** record and report to the Chief Referee any violation of the Rules within the Finish Funnel observed personally, or reported by appointed Finish Judges.

**3.6.4** collect after the race, signed results sheets from each Finish Judge and establish the result and placing which shall be sent directly to the Recorder.

**3.6.5** confirm to each race judge their escort boat and instruct them in their duties.

### **3.7 Finish Judges**

Finish Judges (two) shall:

**3.7.1** be positioned in line with the finish where they shall have at all times a clear view of the finish.

**3.7.2** record after each finish the placing of the competitors according to the assignment given.

**3.7.3** record any violation of the Rules personally observed within the Finish Funnel on the record sheets provided, then communicate the violation to the Chief Finish Judge.

*NOTE: Finish Judges shall not act as Timekeepers in the same event*

### **3.8 Race Judge**

Each Race Judge shall

**3.8.1** be positioned in an escort safety craft (where applicable), assigned by random draw prior to the start, so as to be able to observe, at all times, their appointed competitor.

**3.8.2** ensure at all times that the Rules of competition are complied with, violations being recorded in writing and reported to the Chief Referee at the earliest opportunity.

**3.8.3** have the power to order a competitor from the water upon expiry of any time limit so ordered by the Chief Referee.

**3.8.4** ensure that their appointed competitor does not take unfair advantage or commit unsporting impediment on another competitor and if the situation requires instruct a competitor to maintain clearance from any other competitor.

### **3.9 Turn Judges**

Turn Judges shall:

**3.9.1** be positioned so as to ensure all competitors execute the alterations in course as indicated in the competition information documents and as given at the pre-race briefing.



**3.9.2** record any infringement of the turn procedures on the record sheets provided, then immediately communicate the infringement to the Chief Referee.

**3.9.3** promptly upon completion of the event deliver the signed record sheet to the Recorder.

**3.10 Feeding Platform Judge**

Each Feeding Platform Judge shall be responsible for the management of the activity and the competitors authorised representatives present on the platform, in accordance with World Aquatics rules.

**3.10.1** Feeding Platform Judges will be responsible for checking that all authorised representatives are complying with the use of supplied World Aquatics biodegradable bottles as per Part Three, Section 5.13.5.

**3.11 Relay Judge**

The Relay Judge/s shall manage the activity on the Relay platform or change-over zone to ensure all changeovers occur in accordance with the rules whereby the arriving competitor completes their lap before the departure of the next competitor.

**3.12 Safety Officer**

The Safety Officer shall:

**3.12.1** be responsible to the Chief Referee for all aspects of safety related to the conduct of the competition.

**3.12.2** check that the entire course, with special regard to the start and finish areas, is safe, suitable, and free of any obstruction.

**3.12.3** be responsible for ensuring that sufficient powered safety craft are available during the competition so as to provide full safety backup to the escort safety craft.

**3.12.4** provide prior to the competitions to all competitors a tide/current chart clearly indicating the time of tide changes on the course and showing the effect of tides or current on a competitor's progress along the course.

**3.12.5** in conjunction with the Medical Officer advise the Chief Referee if, in their opinion, conditions are unsuitable for staging the competition and make recommendations for the modification of the course or the manner in which the competition is conducted.

**3.12.6** monitor temperature conditions periodically during the race.

**3.13 Medical Officer**

The Medical Officer shall:

**3.13.1** be responsible to the Chief Referee for all medical aspects related to the competition and competitors.

**3.13.2** inform the local medical facilities of the nature of the competition and ensure that any casualties can be evacuated to medical facilities at the earliest opportunity.

**3.13.3** in conjunction with the Safety Officer, advise the Chief Referee if, in their opinion, conditions are unsuitable for staging the competition and make recommendations for the modification of the course or the manner in which the competition is conducted.

**3.14 Course Officer**

The Course Officer shall:

**3.14.1** be responsible to the Management Committee for the correct survey of the course.

**3.14.2** ensure the start and finish areas are correctly marked and all equipment has been correctly installed and, where applicable, is in working order.

**3.14.3** ensure all course alteration points are correctly marked and manned prior to the commencement of the competition.

**3.14.4** with the Referee and Safety Officer inspect the course and markings prior to the commencement of competition.

**3.14.5** ensure that Turn Judges are in position prior to the start of the competition and report this to the Chief Referee.

**3.15 Clerk of the Course**

The Clerk of the Course shall:





- 3.15.1** assemble and prepare competitors prior to each event and ensure proper reception facilities at the finish are available for all competitors.
- 3.15.2** ensure each competitor is identified correctly with their race number and that all competitors have trimmed fingernails and toenails and are not wearing any jewellery, including watches.
- 3.15.3** record all approved wearables declared in the First Call room.
- 3.15.4** be certain all competitors are present, in the assembly area, at the required time prior to the start.
- 3.15.5** keep competitors and officials informed of the time remaining before the start at suitable intervals until the last five minutes, during which one- minute warnings shall be given.
- 3.15.6** be responsible for ensuring that all clothing and equipment left in the start area is transported to the finish area and kept in safekeeping.
- 3.15.7** ensure that all competitors leaving the water at the finish have the basic equipment required for their well-being should their own attendants not be present at that time.
- 3.15.8** The Clerk of the Course shall notify the Chief Referee and Recorder of any withdrawals and DNF's (Did-Not-Finish).

#### **3.16 Recorder**

The recorder shall record withdrawals from the competition, enter results on official forms, and maintain records for team awards as appropriate.

#### **3.17 Video Review Judge (VRJ)**

- 3.17.1** At World Aquatics events where there is a Decision Review System (DRS) in use a Video Review Judge (VRJ) is to be appointed.
- 3.17.2** The DRS system will be used to assist the Chief Referee to make any decisions to enforce any violation of the Competition Regulations.
- 3.17.3** The Video Review Judge (VRJ) shall review all finishes of the Race from the entry of the Finish Funnel to the Finish Plate, and record and report any violation of the Rules to the Chief Referee.
- 3.17.4** For the 3km Knockout Sprint races the Video Review Judge (VRJ) shall enforce any violations of the Rules that they personally observe using the Decision Review System (DRS) if in use, and report these to the Chief Referee.
- 3.17.5** The Chief Referee will review and consider any violations reported by the Video Review Judge (VRJ) after the competition has finished.

## **4 THE START**

- 4.1** All Open Water competitions shall start with all competitors wearing an approved swim cap and standing on a fixed platform or in water depth sufficient for them to commence swimming on the start signal.
  - 4.1.1** When starting from a fixed platform competitors shall be assigned a position on the platform, as determined by random draw.
  - 4.1.2** For Olympic Games, World Aquatics Championships, and other World Aquatics competitions, the start shall be from a fixed platform.
- 4.2** The Clerk of the Course shall keep competitors and officials informed of the time before start at suitable intervals and at one-minute intervals for the last five minutes.
- 4.3** When the numbers of entries dictate the start shall be segregated into Men's and Women's competitions.
- 4.4** The start line shall be clearly defined by either overhead apparatus or by removable equipment at water level.
- 4.5** The Chief Referee shall indicate by a flag held upright and short blasts on a whistle when the start is imminent and indicate that the competition is under Starter's orders by pointing the flag at the Starter.
- 4.6** The Starter shall be positioned so as to be clearly visible to all competitors.
  - 4.6.1** On the Starter's command "take your marks" all competitors shall take up a starting position immediately in line with the start line where a platform is not used, or with at least one foot at the front of the platform.
  - 4.6.2** The Starter will give the starting signal when he/she considers all competitors are ready.



- 4.7** The start signal shall be both audible and visual.
- 4.8** If in the opinion of the Chief Referee an unfair advantage has been gained at the start the offending competitor will be given a yellow or red flag in accordance with Part Three, Article 5.3.
- 4.9** All escort safety craft shall be stationed prior to the start so as not to interfere with any competitor, and if picking up their competitor from behind shall navigate in such a way as not to manoeuvre through the field of competitors.
- 4.10** Although they may start together, in all other respects the men's and women's competitions shall be treated as separate events.

## **5 THE RACE**

- 5.1** All Open Water Swimming competitions shall be Freestyle events and competitors are required to complete the whole course, respecting all designated turn buoys and course boundaries.
- 5.2** Race Judges shall instruct any competitor who is, in their opinion, taking unfair advantage by pacing or slip streaming with the escort craft to move clear.
- 5.3 Disqualification Procedure**
- 5.3.1** If in the opinion of the Chief Referee or Referees, any competitor, or competitor's approved representative, or escort safety craft, takes advantage by committing any violation of the rules or by making intentional contact with any competitor, the following procedure shall apply:
- 5.3.1.1 1st Infringement:**
- A yellow flag and a card bearing the competitor's number shall be raised to indicate and to inform the competitor that they are in violation of the Rules.
- 5.3.1.2 2nd Infringement:**
- A red flag and a card bearing the competitor's number shall be raised by the Referee (Part Three, Article 3.1.6) to indicate and to inform the competitor that they are for the second time in violation of the Rules. The competitor shall be disqualified.
- 5.3.2** If in the opinion of a Referee, an action of a competitor or an escort safety craft, or a competitor's approved representative is deemed to be 'unsporting' the Referee shall disqualify the competitor concerned immediately. The competitor must leave the water immediately and be placed in an escort craft and take no further part in the race.
- 5.4** Escort safety craft shall manoeuvre so as not to obstruct or place them directly ahead of any competitor and not take unfair advantage by pacing or slip streaming.
- 5.5** Escort safety craft shall attempt to maintain a constant position so as to station the competitor at, or forward of, the mid-point of the escort safety craft.
- 5.6** Standing on the bottom during a race shall not disqualify a competitor, but they may not walk or jump.
- 5.7** With the exception of Part Three, Article 5.6 the competitor shall not receive support from any fixed or floating object and shall not intentionally touch or be touched by their escort safety craft or crew therein.
- 5.7.1** Rendering assistance by an official medical officer to a competitor in apparent distress should always supersede official rules of disqualification through "intentional contact" with a competitor (Part Three, Article 5.3.1).
- 5.8** For races where escort boats are used, each escort safety craft shall contain: a Race Judge, a person of the competitor's choice, and the minimum crew required to operate the escort safety craft.
- 5.8.1** Each escort safety craft shall display the competitor's competition number so as to be easily seen from either side of the escort safety craft and the national flag of the competitor's Federation.
- 5.9** Each safety craft shall contain appropriately qualified safety personnel and the minimum crew required to operate the safety craft.
- 5.10** No competitor shall be permitted to use or wear any device which may be an aid to their speed, endurance, or buoyancy. Approved swimsuit, goggles, a maximum of two (2) caps, nose clip and earplugs may be used.



**5.11** Competitors shall be allowed to use grease or other such substances providing these are not, in the opinion of the Chief Referee, excessive.

**5.12** The pacing of a competitor by another person entering the water is not permitted.

**5.13 Feeding**

**5.13.1** Feeding poles are not to exceed 5m in length when extended. No objects, rope or wire may hang off the end of feeding poles except national flags. National flags are allowed to be attached to the feeding pole but may not exceed the size of 30cm x 20 cm. Flags shall be of fabric material with no hard edges and without any weight or other items added.

**5.13.2** Coaching and the giving of instructions by the approved competitor's representative on the feeding platform or in the escort safety craft is permitted. No whistle shall be allowed.

**5.13.3** When taking sustenance, competitors may use Rule under Part Three, Article 5.6 provided that Rule under Article 5.7 is not infringed.

**5.13.4** No objects can be thrown from the feeding platform to the competitors, including sustenance. The competitors shall receive their feeding in biodegradable containers directly from their representative by a feeding pole or by hand.

**5.13.5** For World Aquatics events, it is mandatory that World Aquatics biodegradable bottles are used. Each athlete will be given 6 bottles (distributed via National Federation).. Feeding Judges shall check all feeders are complying with this rule.

**5.14 Time Limits**

In all events, time limits shall apply as follows from the finish time of the first competitors:

- 15 minutes per 5km (or part thereof) up to a maximum time limit of 120 minutes.

**5.14.1** Competitors who do not finish the course within the time limit shall be removed from the water except that the Chief Referee may allow a competitor outside the time limit to complete the course but not be eligible for any points or prizes.

**5.15 Emergency Abandonment**

**5.15.1** In cases of emergency abandonment of races of 10 km or less, the race will be restarted from the beginning at the earliest possible moment.

**5.15.1.1** Where a competitor/s has completed the race prior to abandonment, the final ranking will be as reported by the Chief Referee having regard to those competitor(s) who have already finished.

**5.15.2** In cases of emergency abandonment for any race longer than 10km, the final ranking will be as reported by the Chief Referee. If 2 hours of the race have not been completed, it will be restarted from the beginning at the earliest moment possible.

## **6 THE FINISH OF THE RACE**

**6.1** Escort safety craft should be stationed at the approach to and entrance of the finish funnel to ensure that only the escort safety craft authorised to do so enter or cross this entrance.

**6.2** The final places will be determined by the Chief Referee based upon the Finish Judges' report and the finish video tape.

**6.3** All competitors must start the race with a microchip transponder on each wrist. If a competitor loses a transponder the Race Judge or other authorised Official, will immediately inform the Chief Referee who will instruct the responsible Official on the water to issue a replacement transponder. All competitors need to finish with at least one transponder on their wrist. Any competitor who finishes the race without at least one transponder will be disqualified.

**6.4** When, at the finish of an Open Water Swimming competition, a finish plate is available, competitors must touch the finish plate to finish the race. Any competitor who does not touch the finish plate will be disqualified.

**6.5** The Finish Judges and Timekeepers shall be placed so as to be able to observe the finish at all times. The area in which they are stationed should be for their exclusive use.



- 6.6** Every effort should be made to ensure that the competitor's representative can get from the escort safety craft to meet the competitor as they leave the water.
- 6.7** Upon leaving the water some competitors may require assistance. Competitors should only be touched or handled if they clearly display a need, or ask for assistance.
- 6.8** A member of the medical team should inspect the competitors as they leave the water. A chair, in which the competitor can sit while an assessment is made, should be provided.
- 6.9** Once cleared by the medical member, competitors should be given access to refreshment.

## **7 SWIMWEAR & TECHNOLOGY**

- 7.1** For Open Water Swimming competitions with water temperature from 18°C and above, swimsuits (men and women) shall not cover the neck, nor extend past the shoulder, nor extend below the ankle. Subject to these specific shape specifications, swimsuits for open water swimming competitions shall further comply with all other requirements applicable to swimsuits for swimming-pool competition.
- 7.2** For Open Water Swimming competitions in water with temperature below 18°C, the use of wetsuits is compulsory. Wetsuits are not permitted in Open Water Swimming competitions in water with temperature 18.0°C and above, except when conditions are hazardous for the competitors, the Chief Referee may, upon recommendation from the Safety Officer & Medical Officer declare wetsuits as mandatory in temperatures up to 20.0°C.

### **7.3 Wetsuits**

Wetsuits shall completely cover torso, back, and thighs. They shall not extend beyond the neck, wrists and ankles.

The body parts, after the shoulder and/or below the thigh do not necessarily need to be covered.

### **7.4 Team Event**

All competitors from the same team must wear the same team caps which shall also comply with these Regulations, Part One, Article 8.6

### **7.5 Technology**

Technology such as drones, GPS tracking, bio-medical sensors or devices that record blood pressure, body temperature, stroke rate, breathing rate etc. via the transponder are permitted when approved by World Aquatics.

The technology may transmit such information but not act as a receiver giving information and advantage to the competitor such as "smart goggles", hearing devices, and the like.

An approved list of Wearables for World Aquatics competitions is available ([HERE](#)).

Competitors must declare all Wearables when reporting to the First Call Room. Failure to declare may result in disqualification from the event.

## **8 IDENTIFICATION OF COMPETITORS DURING THE RACE**

### **8.1 Numbering of competitors**

The numbering of Competitors is to appear on the arms, upper backs and hands of competitors. On the arms the numbers shall be arranged vertically. On the upper backs and hands the numbering is horizontally. Numbering of the arms and backs shall be 100 mm high x 60 mm wide. The numbering of the hands of competitors is allowed by marking pens. For Competitors with darker skin and full body wet suits a white marker pen will be required.

## **9 OPEN WATER SWIMMING FACILITIES AND EQUIPMENT**

### **9.1 Open Water Swimming Facilities**

#### **9.1.1 Start Platforms**



Start Platforms shall be of sufficient size to allow 60cm space per competitor plus an additional 5m. Each competitor space should be identified and numbered with number 1 farthest from the entry to the platform. They shall be of sufficient width to allow for the necessary activities prior to the start and to support the weight of the competitors and officials at the start.

## **9.1.2 Finish**

**9.1.2.1** The final approach to the finish shall be clearly defined with markers of a distinctive colour and shall comprise the boundary of the course.

**9.1.2.2** The area leading to the finish apparatus should be clearly marked by rows of buoys which narrow as they get closer to the finish wall. For World Aquatic events these buoys shall be inflatable tubes.

**9.1.2.3** The finish shall be clearly defined and marked by a vertical face.

**9.1.2.4** The finish apparatus should, where possible, be a finish plate at least 5 metres wide fixed if necessary to floatation devices, securely fastened in place so as not to be moved by wind, tide or the force of a competitor striking the wall. The finish should be filmed and recorded from each side and above by a video system with slow motion and recall facilities including timing equipment. For Olympic Games, World Aquatics Championships and other World Aquatics competitions this is mandatory.

**9.1.2.5** Additional cameras on each side of the finish plate are required for the Decision Review System (DRS) described in Part 3, 9.4. these cameras shall cover the breadth of the finish funnel continuously from the entrance until overlapping the coverage provided by the finish cameras described in 9.1.2.4

## **9.1.3 Turns / Alterations**

**9.1.3.1** All turns/alterations of the course shall be clearly indicated. Turn Buoys which are alterations of the course shall be of a different colour to guidance buoys. Wherever possible there shall be a long distance (to be approved by World Aquatics) from the start to the first turning buoy to ease congestion at the turn.

**9.1.3.2** A clearly marked craft or platform, containing a Turn Judge, shall be positioned at all alterations of course in such a manner as not to obstruct a competitor's visibility of the turn.

## **9.1.4 Feeding Platforms**

Feeding platforms shall be of sufficient size and buoyancy for the safe operation of the platform and the feeders and officials operating thereon. A minimum of 60cm of linear space per feeder plus 5m shall be required and of sufficient width to allow storage a preparation for competitor feeding. There needs to be sufficient space on one or more platforms to accommodate all feeders. Access to the platform shall be outside of the course wherever possible.

## **9.1.5 All Platforms**

All Starting Platforms, Feeding Platforms, Relay Platforms, turning apparatus and Turn Judges craft/platforms shall be securely fixed in position and not be subject to tidal, wind or other movements.

## **9.1.6 Water Conditions**

**9.1.6.1** A certificate of suitability for use of the venue shall be issued by the appropriate local health and safety authorities. In general terms the certification must relate to water purity and to physical safety from other considerations.

**9.1.6.2** The minimum depth of water at any point on the course shall be 1.40 metre.

**9.1.6.3** The water temperature should be a minimum of 16.0°C and a maximum of 31.0°C. It should be checked the day of the race, 2 hours before the start, at three points around the course at a depth of 40 cm. The agreed temperature will be the average of the three taken. This control should be done in the presence of a Commission made up of the following persons present: a Referee, a member of the Organising Committee and one coach from the teams present designated during the Technical Meeting.

## **9.2 Automatic officiating equipment for open water swimming**



The operation of Automatic Officiating Equipment shall be under the supervision of appointed officials. Results recorded by Automatic Equipment shall be used to determine the winner, all placings and the time applicable to each competitor, The placing and times so determined shall have precedence over the decisions of Finish Judges & Timekeepers. In the event that a break-down of the Automatic Equipment occurs or that it is clearly indicated that there has been a failure of the Equipment, or that a competitor has failed to activate the Equipment, the recordings of the judges & timekeepers shall be official.

#### **9.2.1 Microchip Transponders**

When Automatic Officiating Equipment is used for timing of competitions in accordance with these Regulations microchip transponder technology capable of providing split times is mandatory and should be added to the Equipment. Use of microchip transponder technology is mandatory for World Aquatics competitions, at the World Aquatics Championships and Olympic Games. Microchip transponder timing technology will be recorded officially in tenths of seconds.

#### **9.2.2 Intermediate Timing Gate**

Where an intermediate timing gate is used it shall be placed such that it becomes part of the overall course within the swimming line of the course without deviation for the competitors. It shall be a minimum width of 6m wide at the swimming waterline.

#### **9.3 Automatic Officiating procedure for Open Water Swimming**

**9.3.1** Any timing device that is terminated by an official shall be considered a watch. Such manual times must be taken by three timekeepers appointed or approved by the Member in the country concerned. All watches shall be certified as accurate to the satisfaction of the governing body concerned. Manual timing shall be registered to 1/10 of a second. Where no Automatic Equipment is used, official manual times shall be determined as follows:

**9.3.1.1** If two (2) of the three (3) watches record the same time and the third disagrees, the two identical times shall be the official time.

**9.3.1.2** If all three (3) watches disagree, the watch recording the intermediate time shall be the official time.

**9.3.1.3** With only two (2) out of three (3) watches working the average time shall be the official time. When this calculation results in a value that is expressed in hundredths of a second, the final digit shall be dropped without rounding.

**9.3.2** When the Automatic Officiating Equipment fails to record the place and/or time of one or more competitors in a given race:

**9.3.2.1** Record all available Automatic Officiating Equipment times and places,

**9.3.2.2** Record all human times and places.

**9.3.2.3** The official place will be determined as follows:

- A competitor with an Automatic Officiating Equipment time and/or place must retain his/her relative order when compared with the other competitors having an Automatic Officiating Equipment time and/or place within that race.
- A competitor not having an Automatic Officiating Equipment place shall have their place established by the Chief Referee from the video recording of the finish of the race.
- A swimmer having neither an Automatic Officiating Equipment place nor an Automatic Officiating Equipment time shall establish their relative order by the place recorded by the Finish Judges.

#### **9.4 Decision Review System (DRS)**

**9.4.1** Decision Review System (DRS) is a system for collecting and reviewing images to be analysed at the end of the race by the Chief Referee as a means of decision support for an infraction that has been reported to the Chief Referee by any authorised Official.

**9.4.2** At World Aquatics competitions where there is a Decision Review System (DRS) in use there will be a Video Review Judge (VRJ) appointed to review available images.

### **10 WATER QUALITY GUIDELINES FOR OPEN WATER**

#### **10.1 Water Quality Guidelines for Open Water Swimming**

##### **10.1.1 Aims**



The intention of these Regulations is to provide guidance to the Organising Committee (OC) of any World Aquatics Open Water Swimming event on matters relating to water quality at a proposed competition or training venue.

In adherence with WHO Guidelines on Recreational Water Quality (2021), these World Aquatics Guidelines provide the following details:

- Identification of significant water contaminants;
- Levels of specified microorganisms;
- A model for sanitary inspection; and
- A combined classification matrix to determine suitability of a competition venue.

### 10.1.2 Background Narrative

World Aquatics hosts Open Water Swimming events in the open sea, lakes, rivers and other inland waterways, commonly over distances of 5km or more. The Technical Open Water Swimming Committee (TOWSC) in collaboration with the Sports Medicine Committee (SMC) works to ensure athlete safety as their priority.

While Open Water Swimming Rules address a number of health and safety factors including water temperature, water quality and other forms of contamination or water hazard, these Guidelines specifically address water quality, with particular focus on the bacterial indicator organisms, intestinal Enterococci and Escherichia Coli (E.coli). These are reliable indicators of faecal contamination from animals, human sewage, or effluent and present the likeliest risk to athlete welfare.

Open-water swimmers may be exposed to contamination from waterborne agents through inhalation, ingestion (swallowing) and by direct skin contact. Sensitive mucosal linings of the eyes, ears, nose, mouth and upper respiratory tract are potential infection entry points during prolonged immersion.

Swallowing a significant volume of contaminated water will challenge the gastrointestinal system and may cause diarrhoea and vomiting. However, these effects are determined primarily by the strain and concentration of a specific microorganism, the period of exposure and the immune status or susceptibility of the host (the swimmer).

Consequences may range from mild to moderate gastrointestinal symptoms, ear, nose and eye infections, and in some susceptible individuals, respiratory illness. In most cases however, symptoms are transient and respond to conservative medical management. However, more serious medical consequences may arise and therefore a competition venue meeting accepted safety standards will clearly minimise risks to the athlete.

The suitability of a potential venue for training or competition is determined by a combined microbial water quality assessment and survey of sanitation. The former quantifies identified bacteria while the latter involves visual inspection, identifying other pollution sources such as runoff from stormwater drains or industrial outflows. The sanitary survey also considers the influence of weather patterns, particularly rainfall, and potential effect on a venue.

### 10.1.3 Assessment of Bacterial Contaminants

Universal agreement has determined intestinal Enterococci and E. coli as the most reliable indicators of faecal contamination in water. Acceptable levels of these organisms for safe swimming are in accordance with limits proposed by the WHO (2021), the United States Environmental Protection Agency (2017), the European Environmental Agency (2020), the New Zealand Ministry of Health (2021) and the Australian National Health and Research Council (2017).

Therefore, World Aquatics applies the following standards at Open Water Swimming venues with a distinction between tidal waters and inland waterways that account for variabilities such as salinity, tidal influence, and distribution of organisms:

cfu = colony forming unit

	<b>Excellent water quality</b>	<b>Good water quality</b>	<b>Unacceptable water quality</b>
<b>Enterococci (cfu/100mL)</b>	<100	<200	>200
<b>E. coli (cfu/100mL)</b>	<250	<500	>500

Table 1. Bacterial levels for sea and transitional (tidal) waters



	<b>Excellent water quality</b>	<b>Good water quality</b>	<b>Unacceptable water quality</b>
<b>Enterococci (cfu/100mL)</b>	<200	<400	>400
<b>E. coli (cfu/100mL)</b>	<500	<1000	>1000

*Table 2. Bacterial levels for inland waterways*

#### 10.1.4 Frequency of water analysis

To be awarded an Open Water Swimming event, the Organising Committee (OC) is obligated to provide the World Aquatics Office with an authorised water quality analysis report from venue samples collected at the site and then again at the following intervals:

- Two (2) months from competition
- Seven (7) days prior to start of competition
- No more than 48hrs prior to competition
- Day of competition\*

Water samples must be collected from three (3) different locations on the course and analysed at an authorised laboratory. The poorest result should determine the overall water quality with the following tolerance levels for respective venues.

*\*NOTE: Day of competition sampling, notwithstanding delayed reporting, will only be used when a change in water quality, caused by storms or other unpredictable factors, needs to be considered in the advent of illness amongst participants. Data from water analysis will guide appropriate treatment.*

##### 10.1.4.1 For ocean and transitional (tidal) waters

- pH between 6 - 9
- Enterococci not more than 100cfu/100mL
- E. coli not more than 250cfu/100mL
- Absence of algal bloom

##### 10.1.4.2 For inland waterways

- pH between 6 - 9
- Enterococci not more than 200cfu/100mL
- E. coli not more than 500cfu/100mL
- Presence of algal bloom and scum formation in inland waterways will necessitate a test for cyanobacteria with results to be confirmed by the appropriate local health authority. A tolerance of less than 100,000 cells/mL is required by World Aquatics.

(Reference: World Triathlon Water Quality Statement 2019)

#### 10.1.5 Sanitary Inspections

A venue sanitary inspection is primarily a "subjective" visual survey, best undertaken by qualified personnel.

This inspection indicates whether the competition venue is potentially susceptible to faecal contamination from other sources. These include inflow identified by local health authorities, from nearby factories, farms, or hotels, as well as the influence of stormwater overflow after periods of heavy rainfall.

In addition, a visual inspection should record areas of stagnation, water clarity, odour, evidence of algal bloom, surface "scum" or visible pollutants such as oil film or "slick." These constitute a "checklist" of sanitary factors to be included by the potential host organisation in their bid document to World Aquatics.

Where there is demonstrable impact from weather events such as heavy rainfall, the bid document should provide clear, documented evidence of water "clearance time" to return the venue to acceptable levels of indicator organisms.





In addition, a visual survey of every venue must also identify potential hazards such as tides, currents, general debris, floating logs or rocky outcrops that could affect the laying of a course or impede or injure a swimmer. These matters overlap the brief of the World Aquatics Safety Officer, whose inspection takes place at the time of competition.

Sanitary Inspection Factors	Excellent Sanitation	Good Sanitation	Poor Sanitation
Algal bloom	absent	absent	present
Surface contaminants (e.g. oil)	absent	absent	present
Water clarity	Visibility to 50 cm	cloudy	cloudy
Odour	absent	moderate	present
Weather effects	nil	present but reducing	present
Active aquatic life	present	present	absent

Table 3. Sanitary Inspection Checklist

## 10.1.6 Regulations for an Open Water Swimming Venue Suitability

### 10.1.6.1 Classification Matrix for Venue Suitability

In meeting obligations to athlete health and safety, the suitability of every World Aquatics Open Water Swimming venue must be determined by considering three data sets, namely:

1. Results of water quality analysis
2. Report from sanitary inspection
3. Knowledge of local weather impact

Consequently, a matrix of classification, modelled on the World Triathlon Water Quality Statement (2019), is used by World Aquatics to assist in determining the suitability of all OWS competition venues.

### 10.1.6.2 Water Quality Decision Matrix for Sea/Ocean and Transitional (tidal) Waters

	Sanitary Category		
	Excellent	Good	Poor
<b>2 past results</b> E. coli <250 Enterococci <100	1	1	2
<b>Last result</b> E. coli 250- 500 Enterococci 100-200	2	2	3
<b>2 past results</b> E. coli 250 -500 Enterococci 100-200	2	3	3
<b>Last result</b> E. coli >500 Enterococci >200	4	4	4

Table 4. Water Quality Decision Matrix for Sea/Ocean and Transitional (tidal) Waters

### 10.1.6.3 Key for Venue Suitability in Transitional Waters



<b>1</b>	<b>Excellent water quality:</b> E. coli <250cfu/100mL or Enterococci <100cfu/100mL with excellent/good sanitary inspection and no forecasted heavy rainfall.
<b>2</b>	<b>Good water quality:</b> E. coli <250cfu/100mL or Enterococci <100cfu/mL with some deficiencies in sanitary inspection or forecasted heavy rainfall. OR E. coli 250-500cfu/100mL or Enterococci 100-200cfu/mL with no deficiencies in sanitary inspection or no forecasted heavy rainfall.
<b>3</b>	<b>Fair water quality:</b> E. coli 250-500cfu/100mL, Enterococci 100-200cfu/100mL with poor sanitary inspection and/or forecasted heavy rainfall.
<b>4</b>	<b>Poor water quality:</b> E. coli >500cfu/100mL, Enterococci >200cfu/100mL with poor sanitary inspection and/or forecasted heavy rainfall.

Table 5. Key for Venue Suitability in Transitional Waters

#### 10.1.6.4 Water Quality Decision Matrix for Inland Waterways

	Sanitary Category		
	Excellent	Good	Poor
<b>2 past results</b> E. coli <500 Enterococci <200	1	1	2
<b>Last result</b> E. coli 500-1000 Enterococci 200-400	2	2	3
<b>2 past results</b> E. coli 500 - 1000 Enterococci 200-400	2	3	3
<b>last result</b> E. coli >1000 Enterococci >400	4	4	4

Table 6. Water Quality Decision Matrix for Inland Waterways

#### 10.1.6.5 Key for Venue Suitability for Inland Waterways

<b>1</b>	<b>Excellent water quality:</b> E. coli <500cfu/100mL or Enterococci <200cfu/100mL with excellent/good sanitary inspection and no forecasted heavy rainfall.
<b>2</b>	<b>Good water quality:</b> E. coli <500cfu/100mL or Enterococci <200cfu/mL with some deficiencies in sanitary inspection or forecasted heavy rainfall. OR E. coli 500-1000cfu/100mL or Enterococci 200-400cfu/mL with no deficiencies in sanitary inspection or no forecasted heavy rainfall.
<b>3</b>	<b>Fair water quality:</b> E. coli 500-1000cfu/100mL, Enterococci 200-400cfu/100mL with poor sanitary inspection and/or forecasted heavy rainfall.
<b>4</b>	<b>Poor water quality:</b> E. coli >1000cfu/100mL, Enterococci >400cfu/100mL with poor sanitary inspection and/or forecasted heavy rainfall.

Table 7. Key for Venue Suitability for Inland Waterways

#### 10.1.7 Open Water Swimming Water Quality Regulations for Venue Suitability Summary

From the above Water Quality Decision Matrices, World Aquatics expects all Open Water Swimming competition venues to meet the criteria outlined in **Level 1, as Excellent water quality**.



However, there will be circumstances where **Level 2 (Good water quality)** may also be considered acceptably safe for competition. As examples, a venue may be considered unsuitable only after heavy rainfall and reclassified satisfactory after water "clearance" or where deficiencies in sanitation such as the presence of debris, hazards or surface contaminants are physically cleared.

All decisions on venue reclassification reside with the joint Commissions of the TOWSC and SMC, or their appointee, in collaboration with the OC Medical Officer.

*NOTE: Water Levels 3 and 4 are unacceptable to World Aquatics for safe competition or training.*

*ACKNOWLEDGEMENT: Special acknowledgement is made of the World Triathlon Water Quality Statement (2019) and the contributions of Sergio Migliorini and Thanos Nikopoulos to their Water Quality Matrix upon which the World Aquatics Water Quality Decision Matrices are based.*

## REFERENCES

- Hall V, Taye A, Walsh B, et al. 2017. A large outbreak of gastrointestinal illness at an open-water swimming event in the River Thames, London. *Epidemiology and Infection* 145: 1246-1255.
- Joosten R, Sonder G, Parkkali S, et al. 2017. Risk factors in gastroenteritis associated with canal swimming in two cities in the Netherlands during the summer of 2015: a prospective study. *PLoS One* 12: e0174732.
- WHO Guidelines on Recreational Water Quality. Volume 1: coastal and fresh waters. Geneva: World Health Organisation; 2021. Licence: CC BY-NC-SA 3.0 IGO.
- Cabelli VJ, Dufour AP, McCabe LJ, et al. 1982. Swimming associated gastroenteritis and water quality. *Amer J Epidemiology* 115:606-616.
- New Zealand Ministry of Health. 2021. ESR Recreational Water Quality Guidelines Update. Wellington.
- European Environment Agency. 2020. State of bathing water. <https://www.eea.europa.eu/themes/water/Europes-seas-and-coasts/assessments/state-of-bathing-water-3>.
- United States Environmental Protection Agency. 2013. Beach sanitary surveys. <http://www.epa.gov/beach-tech/beach-sanitary-surveys>.
- National Health and Medical Research Council. 2017. Guidelines for managing risks in recreational water. Canberra.
- USEPA. 2017. Five-year review of 2012 recreational water quality criteria. Washington DC: United States Environmental Protection Agency. EPA 823 R 18 001.
- Migliorini, S. 2019. World Triathlon Water Quality Statement.

## 11 OPEN WATER SAFETY REGULATIONS

### 11.1 General Concept

**11.1.1** These Regulations shall apply to all open water events of a distance of 5km or greater organized by World Aquatics, sanctioned by World Aquatics, or over which World Aquatics has technical control ("Covered Competitions"). These Regulations shall augment and supersede as applicable, the existing regulations established for specific events.

### 11.1.2 Critical elements of these Regulations include:

- Submission of a site-specific Safety Plan compliant with these regulations as part of the event approval process;
- Approval of the Safety Plan by the World Aquatics Safety Delegate and by the World Aquatics Medical Delegate as a condition of event approval;
- The World Aquatics Safety Delegate and the Medical Delegate should see both plans in advance and work together to ensure both plans mesh where required.
- Appointment of an World Aquatics Safety Delegate who is independent of the Host Member Federation and Organizing Committee ("HMF/OC") to ensure that the approved safety plan and the requirements of these regulations are implemented on race day;
- Authority vested in anyone of the World Aquatics Safety Delegate, the HMF/OC Safety Officer, Medical Officer, or the Chief Referee to postpone, cancel, or modify an event where safety conditions warrant;



- Careful accounting for all competitors before, during and after the race to ensure that all competitors starting the race are accounted for at the time they withdraw or finish the race;
- All competitors must be observed during the race so that there is immediate recognition when a competitor is struggling or loses consciousness.
- There must be immediate rescue available when a competitor is in distress; and
- There must be immediate resuscitation available to address medical emergencies.

## **11.2 Submission of a safety plan to World Aquatics**

**11.2.1** For all Covered Competitions, the HMF/OC for the competition shall submit a site-specific safety plan to World Aquatics for World Aquatics' approval. That safety plan shall comply with all requirements of these regulations.

**11.2.2** Each safety plan shall be reviewed by the World Aquatics TOWSC Safety Delegate, who shall approve, modify, or reject the submitted safety plan.

**11.2.3** No Covered Competition subject to these regulations shall be sanctioned or approved by World Aquatics without an approved safety plan in place.

**11.2.4** Any change to an approved safety plan requested up until five days before the race must be approved by the World Aquatics TOWSC Safety Delegate as provided in Part Three, Article 10.2.2 above. Changes to an approved safety plan necessitated by circumstances beyond the control of the HMF/OC requested within five days of the race, or otherwise required to protect participant safety, may be approved by the World Aquatics Safety Delegate appointed by World Aquatics for the race.

## **11.3 Implementation of the Safety Plan at the Event**

**11.3.1** Concurrently with the awarding of an event, World Aquatics shall appoint an World Aquatics Safety Delegate for each Covered Competition. The World Aquatics Safety Delegate shall be independent of the HMF/OC. The World Aquatics Safety Delegate shall be generally responsible for all matters pertaining to the safety of the competition participants and shall be specifically responsible for ensuring that the approved safety plan and these regulations are followed during the competition.

**11.3.2** The HMF/OC shall appoint an HMF/OC Safety Officer with experience in open water safety and an HMF/OC Safety Crew responsible for organizing and implementing all safety aspects of the competition. The HMF/OC Safety Crew shall include certified local lifeguards with experience in open bodies of water who shall be involved in safety during the competition.

**11.3.3** The World Aquatics Safety Delegate shall inspect the competition venue and meet with the HMF/OC Safety Officer and Safety Crew at least three days prior to the scheduled start of the competition to ensure that the safety plan remains adequate to address the conditions at the competition venue and that all actions necessary to implement the approved safety plan have been taken.

**11.3.4** The World Aquatics Safety Delegate shall have authority to modify, postpone, or cancel the competition whenever the approved safety plan is not being implemented or as otherwise required to protect the safety of participants. The HMF/OC Safety Officer, Medical Officer and the Chief Referee of the race may advise the World Aquatics Safety Delegate on the modification, postponement or cancellation of the competition.

## **11.4 Safety Plans and Race Safety Implementation Requirements**

Each safety plan required by these regulations shall include the following minimum requirements. The implementation of these requirements is mandatory for each Covered Competition.

### **11.4.1 Team Leaders' Meeting**

- a) Team representatives must attend the Team Leaders' Meeting. If a Team Leader or Team's/competitor's representative is unable to attend the Team Leaders' Meeting, the competitor must attend a special safety briefing in order to participate in the race.
- b) Safety topics that shall be included in the Technical Meeting include:
  - explanation of the course layout and hazards
  - tides, currents or other water conditions
  - marine life
  - weather conditions
  - water temperature
  - water quality conditions



- description of the method by which the Safety Committee will monitor swimmers
  - location of safety craft
  - description of medical support onsite and availability of hospital care
  - signal for help-float on back and raise hand for assistance
  - evacuation plan for clearing the racecourse, including description of related visual and audible signals
- c) A short pre-race safety briefing, mandatory for all competitors, shall be held immediately prior to the race.

#### **11.4.2 Monitoring And Rescue Of Swimmers**

- a) Each competitor shall be under the direct observation of at least one HMF/OC Safety Crew member or Referee at all times during the race. The configuration of the course will determine where Safety Crew observers are positioned to observe competitors. For example, in an open course with no physical restraints, and depending on the size of the field, it is ideal to have an escort craft with a designated observer assigned to assure that each competitor is monitored. However, in a competition conducted in a narrow rowing basin, it would be impractical to have individual escort craft on the course, rather, HMF/OC Safety Crew observers may be able to follow the competitors by walking along the shore. In other circumstances, it may be desirable to organise the HMF/OC Safety Crew observers by zone.

Whenever possible, given the layout of the course, HMF/OC Safety Crew observer craft (boats or kayaks) should guarantee that all competitors separated from the lead group or lead competitor can be followed directly by a safety boat or kayak. The safety craft must follow the competitor or group of competitors at a reasonable distance so as to allow immediate intervention if a safety action is required.

- b) There must be sufficient safety craft or escort craft located on the course to immediately recognize when a competitor is in distress and to initiate an immediate rescue response after observation or notification that a competitor's rescue is required. In most course configurations, there should also be stationary safety craft located every 400 meters along the course, with a CPR- and life support- trained responder on board. To accomplish this, there must be sufficient designated rescue landing points along the course and sufficient CPR- and life support-trained personnel in proximity to each competitor or group of competitors.

#### **11.4.3 Safety Communication**

- a) The World Aquatics Safety Delegate and the HMF/OC Safety Officer must have instant two- way communication access with: each other; all members of the HMF/OC Safety Crew assigned to observe competitors; all safety craft; personnel on each feeding platform; the HMF/OC Chief Medical Officer; the Chief Referee; and other course officials. The line of command shall be as follows: the World Aquatics Safety Delegate deals directly with the HMF/OC Safety Officer and the HMF/OC Safety Officer deals directly and shall have the absolute power to mobilize all lifeguards and medical personnel when required.
- b) Safety Crew members assigned to monitor competitors must also be able to instantly communicate with all safety craft.
- c) Two-way radios or other communication equipment with one channel or number reserved for emergencies are required, and a backup system shall also be available.

#### **11.4.4 Accounting for Swimmers**

- a) Each competitor shall have his or her race number marked clearly on his or her body. The Clerk of the Course is responsible for the accountability of all competitors from the start of the race until the last competitor has safely completed the race. As competitors withdraw from or finish the race, the Clerk of the Course shall check off each competitor from the list of competitors who started the race.
- b) No competitor shall exit the race through withdrawal, disqualification, completion, or otherwise-without checking in with the Clerk of the Course.
- c) All competitors should wear when available whatever electronic tracking technology may be required as part of the approved safety plan.

#### **11.4.5 Feeding Stations**

- a) For Covered Competitions greater than five kilometers, a floating or stationary feeding station should be available at least every 2.5 kilometers.

#### **11.4.6 Local Suitability Certificate, Including Water Quality**



- a) The course shall be in water that is subject to only minor currents or tides and shall be free of hazardous obstacles, pollutants, and dangerous marine life.
- b) A certificate of suitability for the use of the venue shall be issued as per Part Three, Article 8.1.6.1 above. The certificate provided in connection with plan approval shall be updated within seventy-two hours of the day of the race.

**11.4.7 Water Temperature**

- a) The water temperature shall be measured before the race as per Part Three, Article 8.1.6.3 above.
- b) The water temperature shall be monitored as provided above at one-hour intervals during the race. If the water temperature drops below 16°C or exceeds 31°C at any of the measuring intervals, the water temperature shall be measured again in 30 minutes and if that measurement is also below 16°C or exceeds 31°C, the race must be stopped until such time as the water temperature complies with this rule.

**11.4.8 Medical Service**

- a) The HMF/OC shall appoint as its Chief Medical Officer a physician with experience in providing medical care during endurance events. Other members of the HMF/OC medical team shall include sufficient individuals with emergency medical training (basic life support and CPR) to staff the stationary safety boats and venue medical facility.
- a) The onsite medical facility shall include basic emergency and trauma equipment, AED, and any heating or cooling facilities required by the approved safety plan.
- b) An ambulance shall be available onsite or on call within five minutes of the venue. It is recommended that a back-up ambulance shall also be available onsite or on call within 15 minutes of the venue.
- c) Where the travel time by ambulance between the venue and the nearest hospital with emergency room facilities is longer than one hour, then the safety plan shall require provision for helicopter transport.

**11.4.9 Safety During Training, Pre-Race Warm Up And Post-Race Warm Down**

- a) The HMF/OC must provide safety monitoring on the course during established training hours. No competitor shall be allowed to enter the racecourse during training without an escort craft. Monitoring of competitors by HMF/OC Safety Crew observers should also occur during pre-race warmups and post-race warm downs.

**11.4.10 Course Evacuation Plan**

- a) Each safety plan must include a course evacuation plan to expeditiously get all competitors and race personnel off the water and to safety in emergency situations.



## **12 APPENDICES**

- 12.1 APPENDIX 1 - Diagram – Field of Play
- 12.2 APPENDIX 2 - Diagram – Crafts Position
- 12.3 APPENDIX 3 - Diagram – Platforms and Buoys
- 12.4 APPENDIX 4 - Diagram – Gates
- 12.5 APPENDIX 5 - Diagram – Gates – Decision Review System (DRS)
- 12.6 APPENDIX 6 – DIAGRAM – TIMING ROOM



12.1 APPENDIX 1 - Diagram - Field of Play

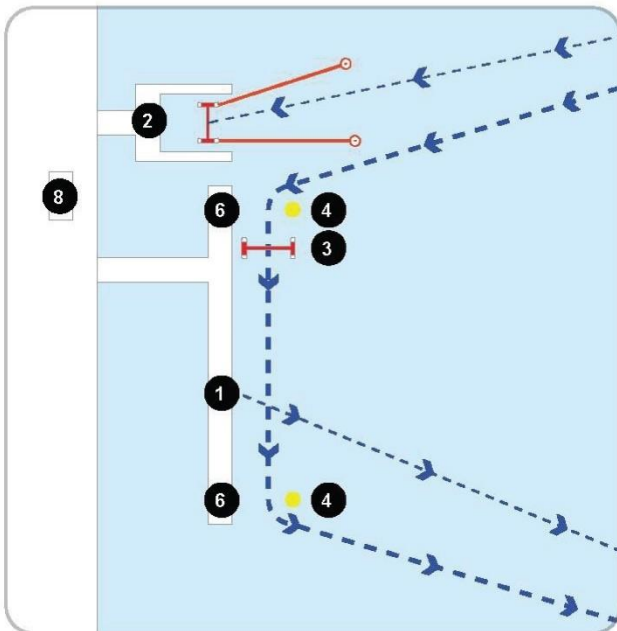
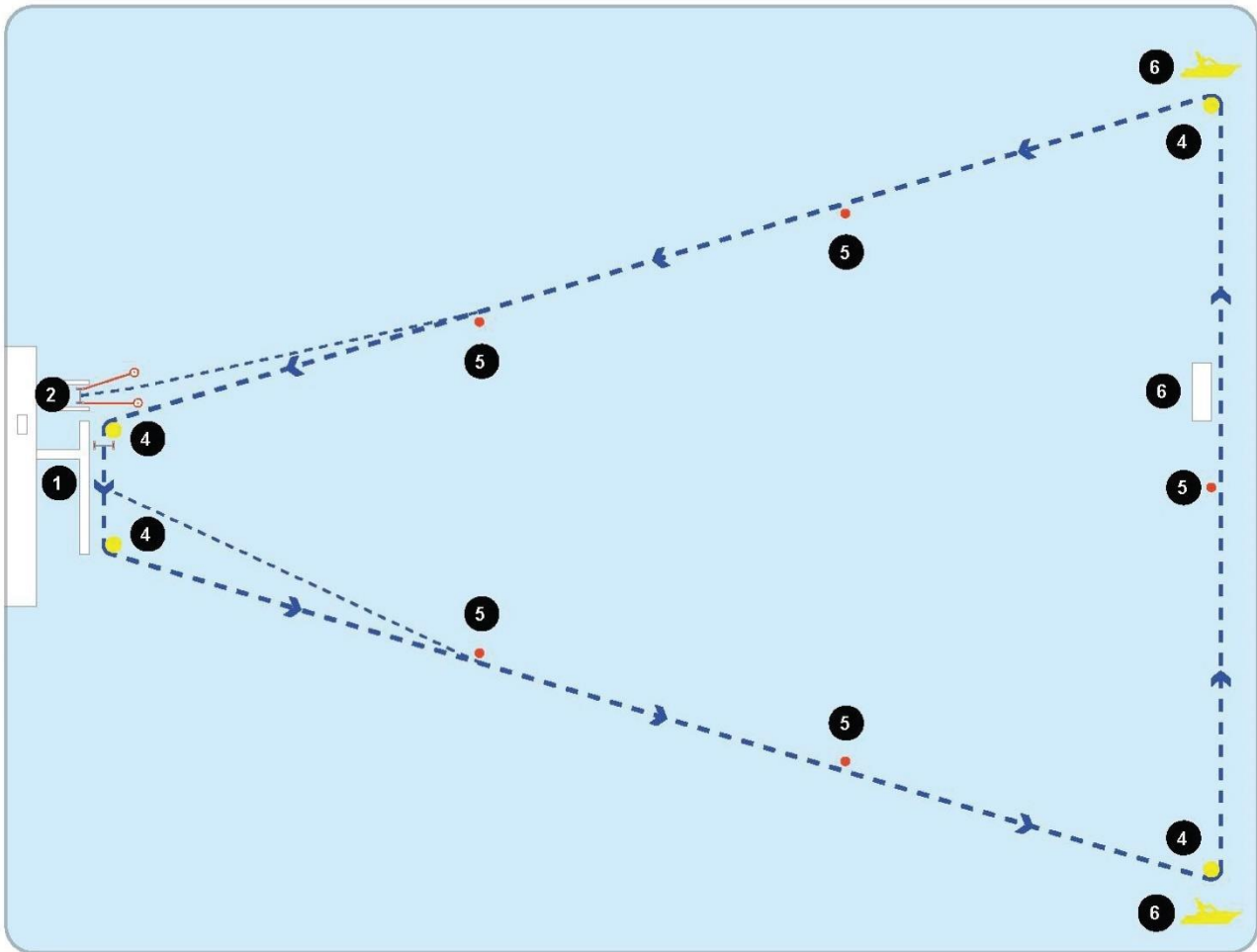

- |                                |                    |
|--------------------------------|--------------------|
| 1 Start Platform               | 7 Feeding Platform |
| 2 Finish Gate                  | 8 Timing Room      |
| 3 Intermediate Gate            |                    |
| 4 Turn Buoy                    |                    |
| 5 Guidance Buoy                |                    |
| 6 Turn Judge platform or craft |                    |

**Water Conditions**

- The course shall be in water that is subject to only minor currents or tide and may be salt or fresh water.
- The minimum depth of water at any point on the course shall be 1.40 meter
- The water temperature should be a minimum of 16°C and a maximum of 31°C. It should be checked the day of the race, 2 hours before the start, in the middle of the course at a depth of 40 cm. This control should be done in the presence of a Commission.





12.2 APPENDIX 2 - Diagram – Crafts Position

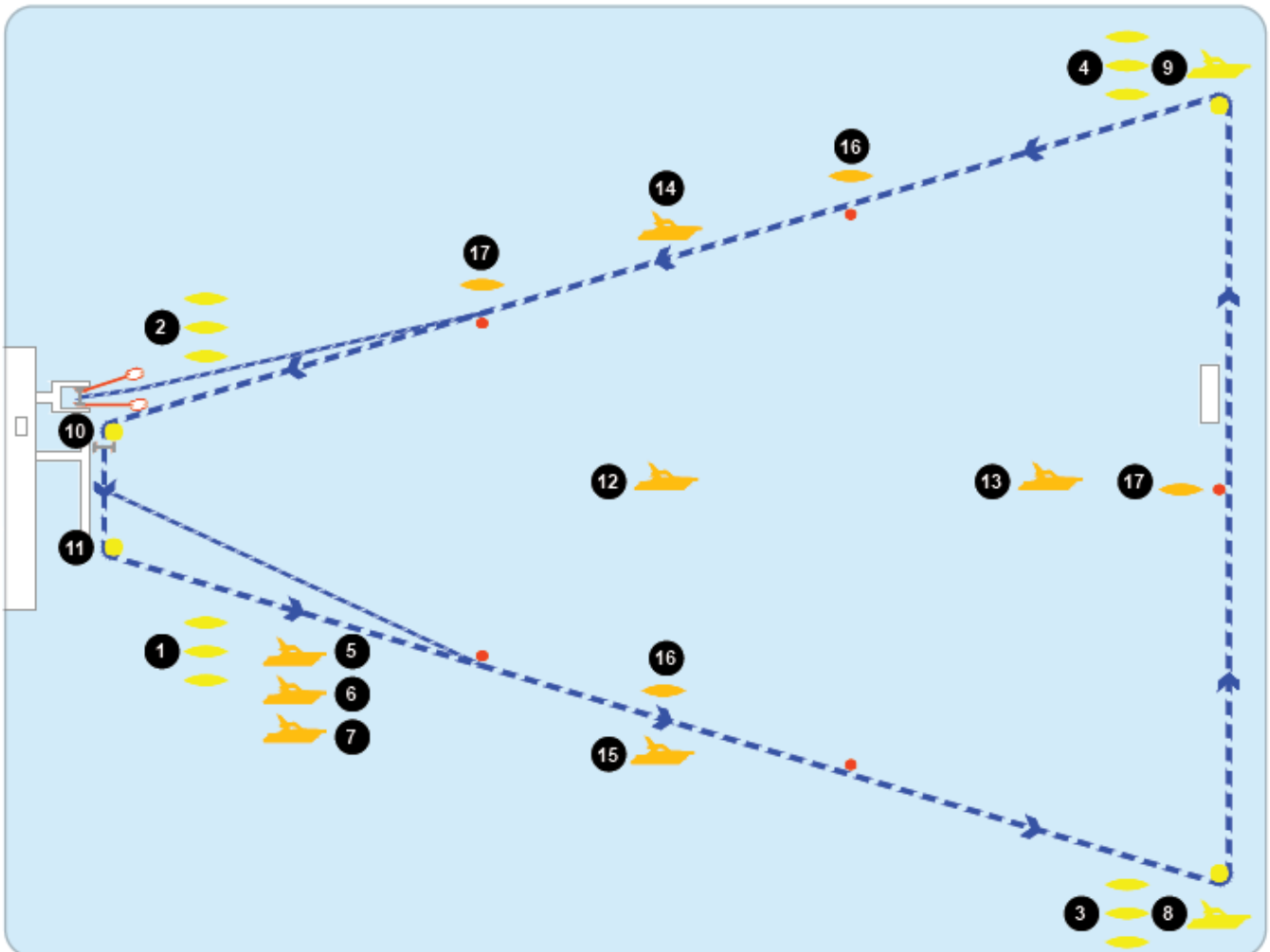

**Operational Plan - Crafts position**

- |                                      |  |
|--------------------------------------|--|
| 1 Kayak - Left side of the pontoon   | 12 Boat - Course Officer                           |
| 2 Kayak - Right side of the pontoon  | 13 Boat - Medical Officer + 1 Driver + 1 Lifeguard |
| 3 Kayak - Right side of Turn 1       | 14 Boat - Safety Officer + 1 Driver + 1 Lifeguard  |
| 4 Kayak - Left side of Turn 2        | 15 Boat - Media + 1 Driver                         |
| 5 Boat - Chief referee 1 + 1 Driver  | 16 Jetski - 1 Paramedic + 1 Driver                 |
| 6 Boat - Referee 1 + 1 Driver        | 17 Jetski - 1 Paramedic + 1 Driver                 |
| 7 Boat - Referee 2 + 1 Driver        |  |
| 8 Platform or Craft* - Turn Judge 1  |  |
| 9 Platform or Craft* - Turn Judge 2  |  |
| 10 Platform or Craft* - Turn Judge 3 |  |
| 11 Platform or Craft* - Turn Judge 4 |  |

\*Craft requires a driver



**12.3 APPENDIX 3 - Diagram – Platforms and Buoys**

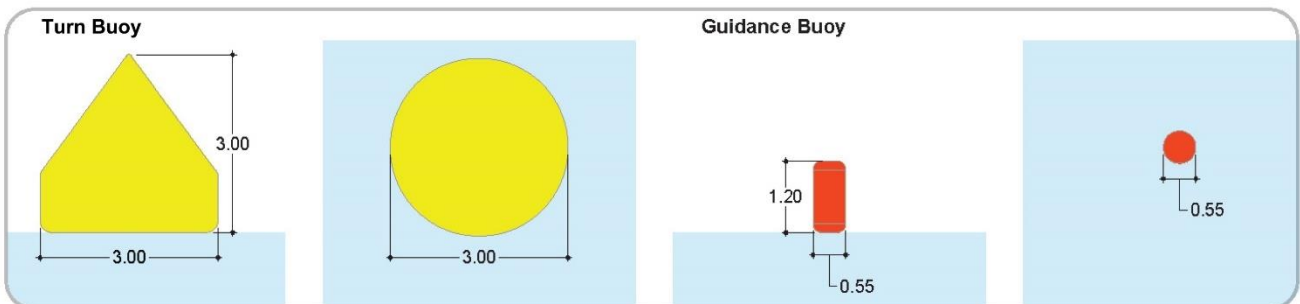
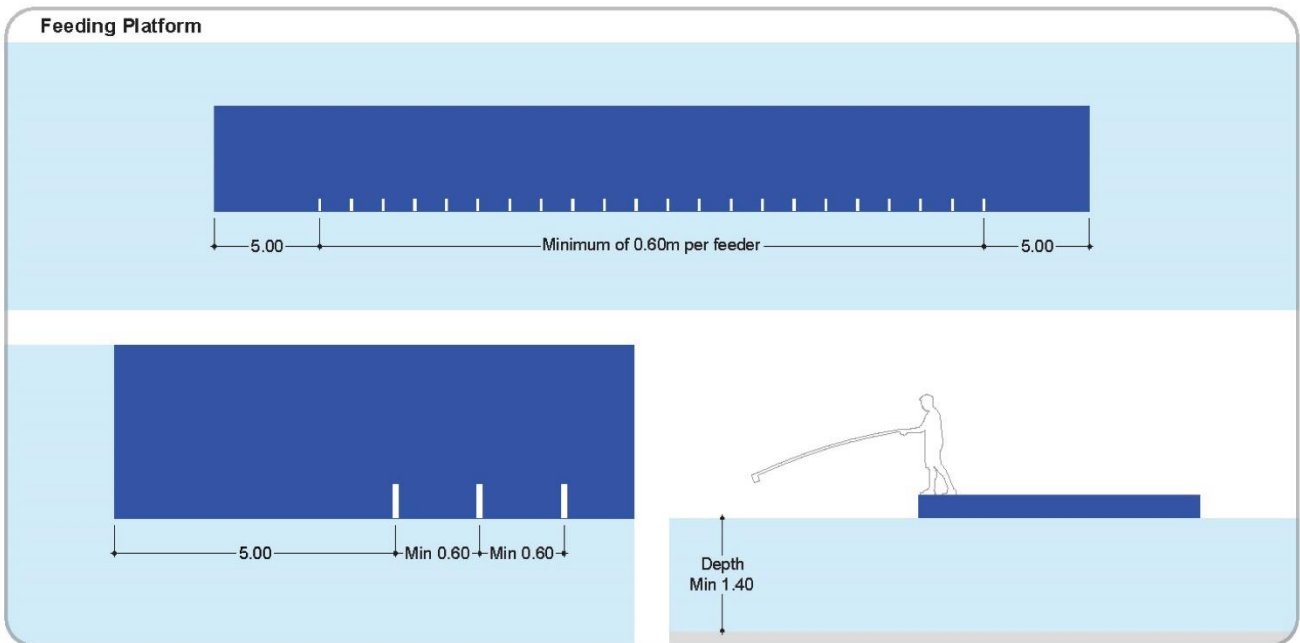
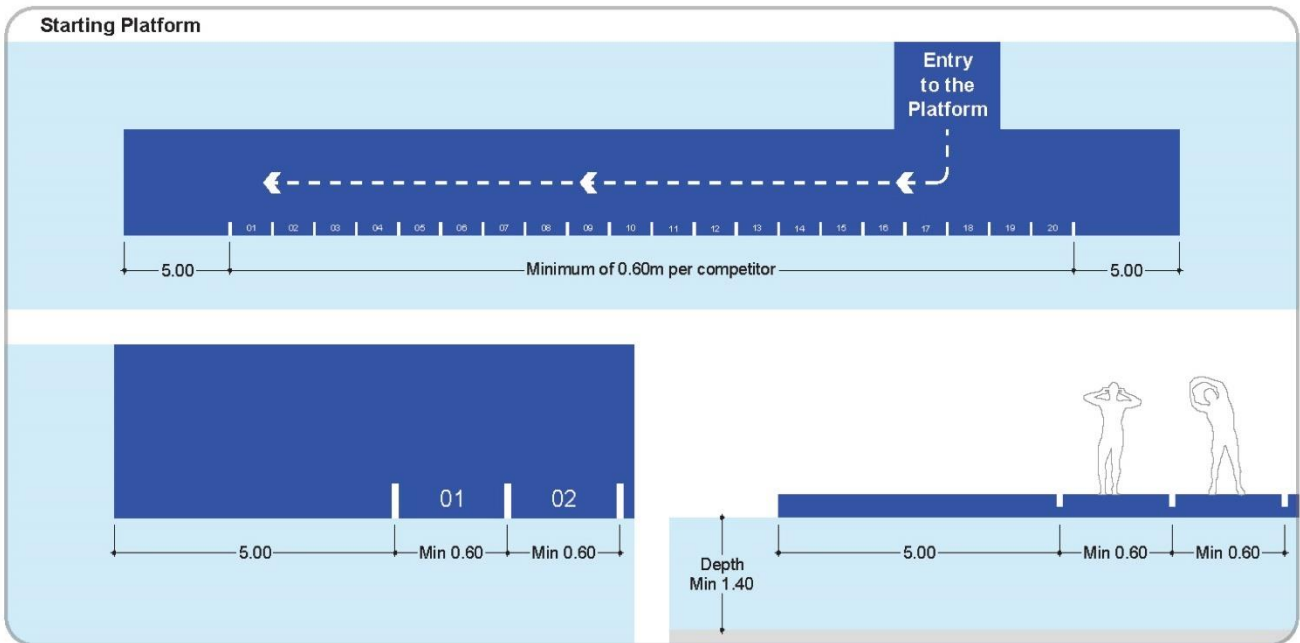



12.4 APPENDIX 4 - Diagram – Gates

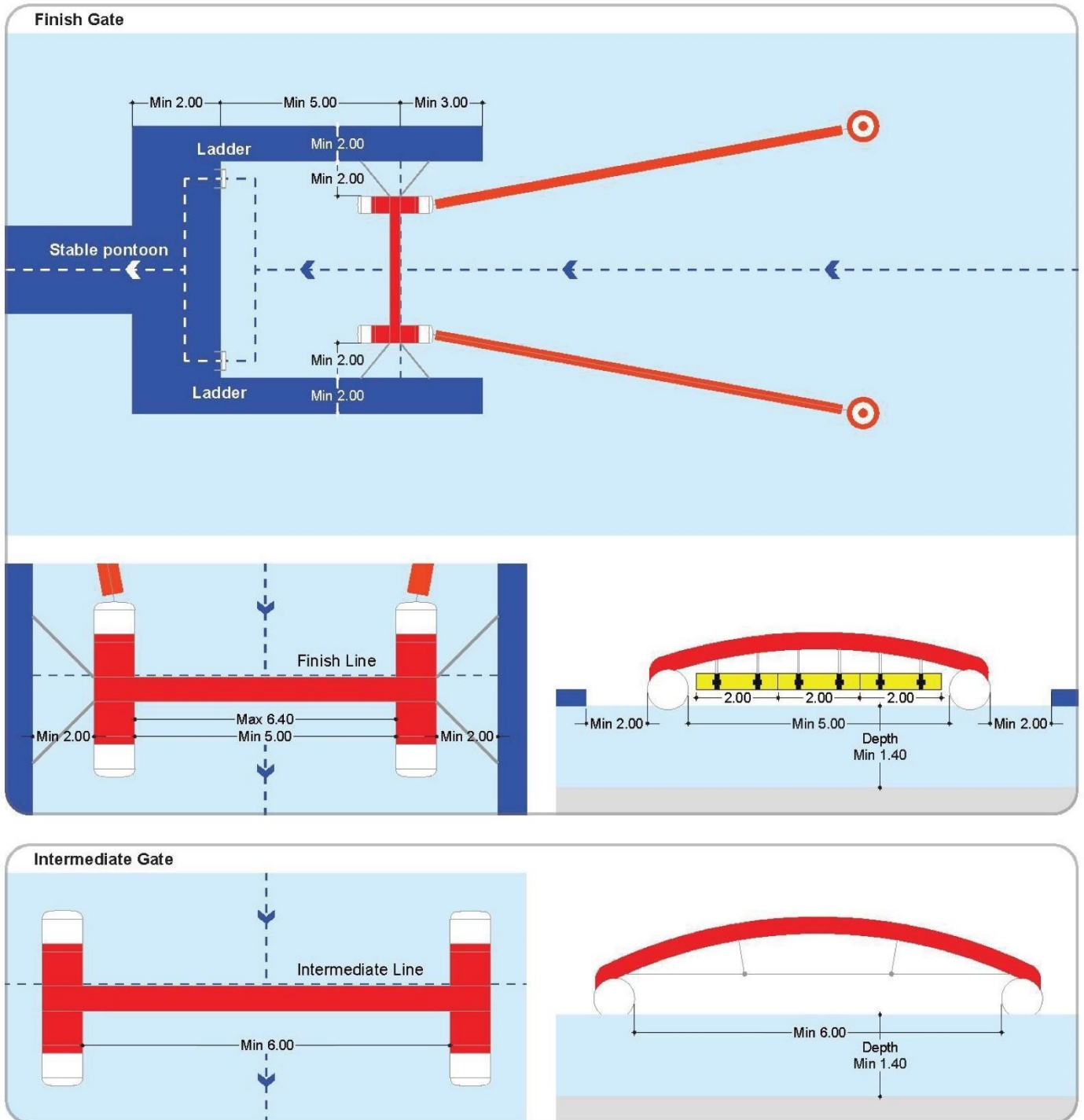



**12.5 APPENDIX 5 - Diagram – Gates – Decision Review System (DRS)**

DRS Video Camera coverage

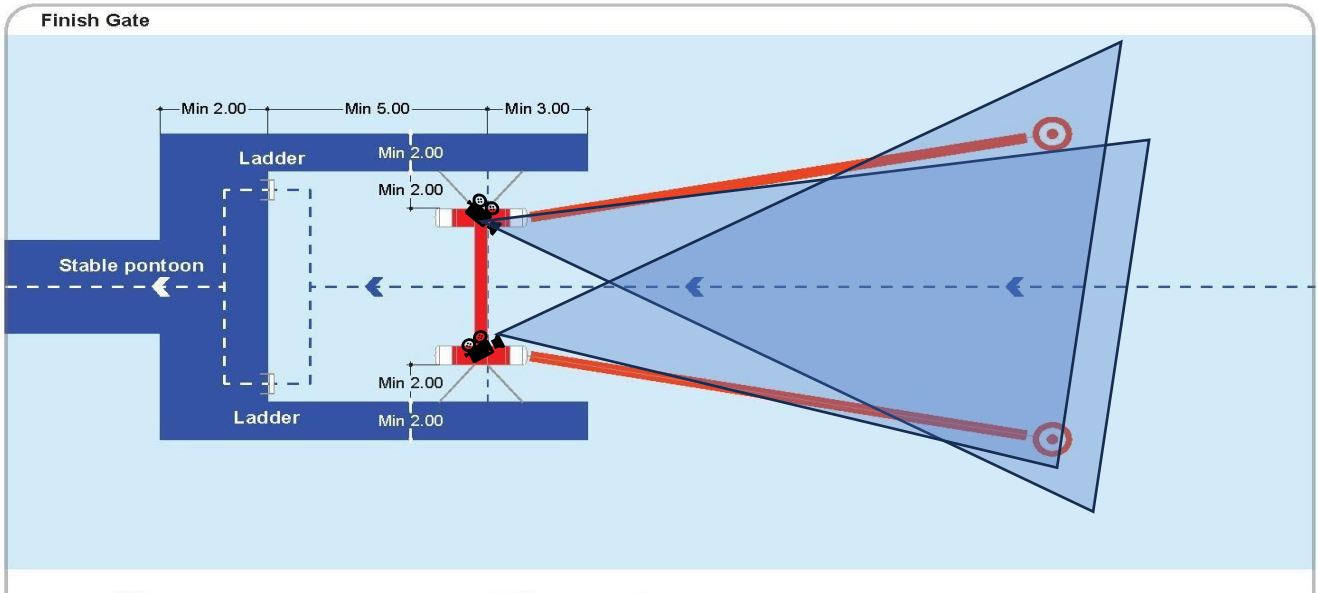

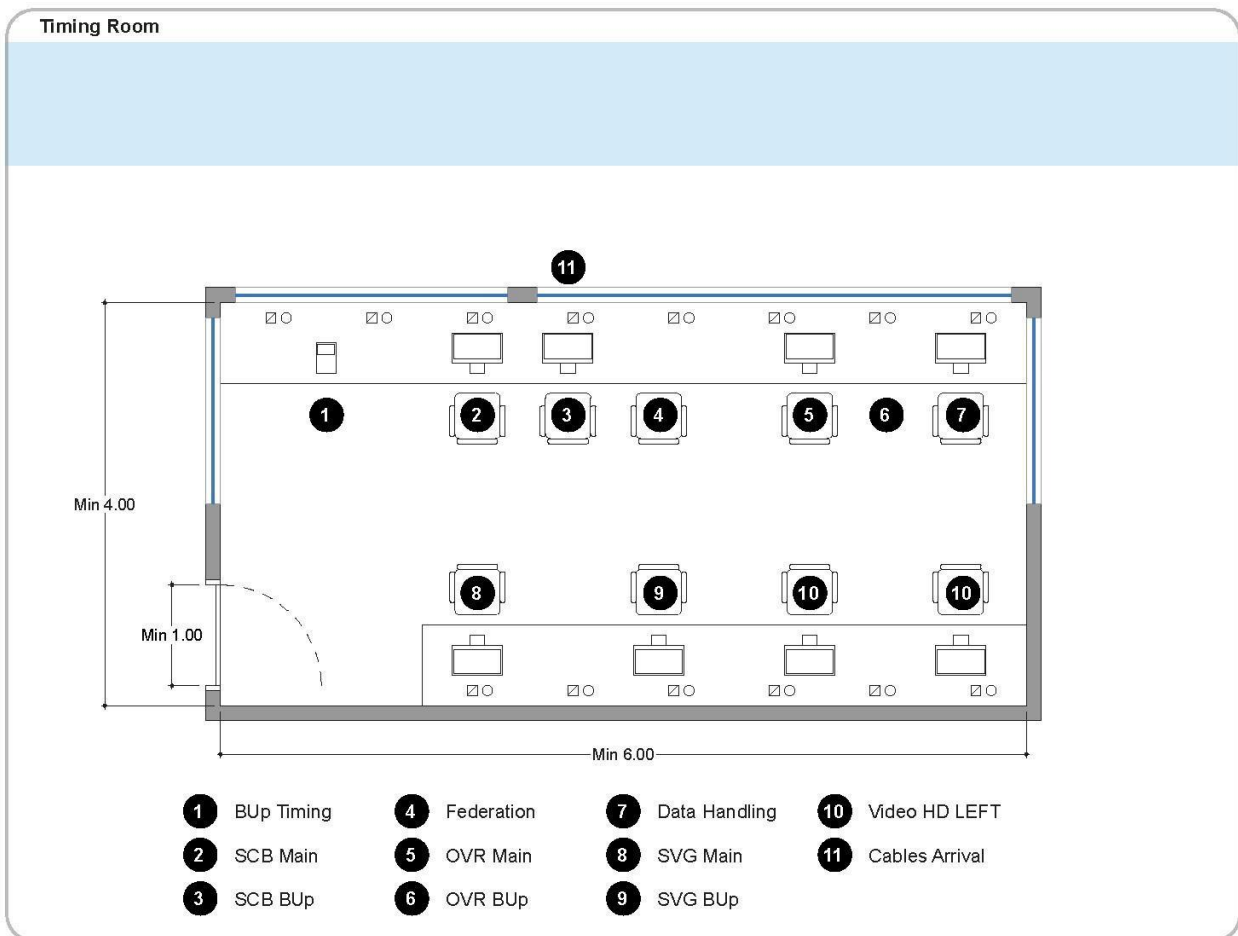
**12.6 APPENDIX 6 – DIAGRAM – TIMING ROOM**

**General Requirements**

- Wireless transmitting devices that are not part of Timing/ Judging equipment are not allowed around the finish area.
- The athletes must wear the microchip with the provided wristband. No modification on the wristband is allowed.
- At the finish, the Chief Referee must go to the Timing room for video judging as soon as possible.
- Timing room must have good visibility on the finish gate. The maximum distance between the finish and the Timing Room shall be 40m.

**Requirements to be provided by OC**

- Rainproof room
- Air Conditioning 18-20°C. Air Conditioning must be adjusted for about 10 people and the equipment.
- Minimum room area: 25m<sup>2</sup>
- Minimum room height: 2.20m
- Power: Each socket 208-240V / 50-60Hz / 2kVA
- View to the FOP
- High speed internet connection
- TV Monitor
- Cables arrival hole
- Tables (Height: Min 70cm, Width: Min 80cm)
- Chairs



WORLD  
AQUATICS

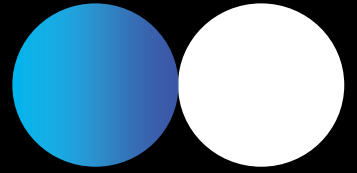

# DIVING

COMPETITION  
REGULATIONS

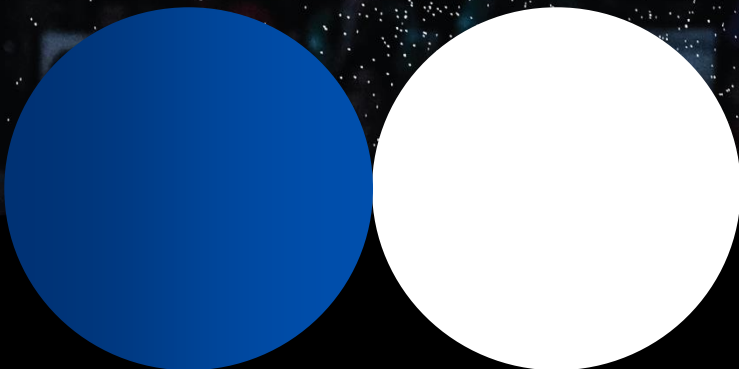



## TABLE OF CONTENTS

### PART FOUR: DIVING RULES

<b>PART FOUR: DIVING RULES</b> .....	<b>136</b>
<b>1</b> GENERAL.....	<b>136</b>
<b>2</b> COMPETITIONS.....	<b>137</b>
<b>3</b> COMPETITION FORMAT.....	<b>138</b>
<b>4</b> STATEMENT OF DIVES.....	<b>139</b>
<b>5</b> COMPETITION PROCEDURE.....	<b>140</b>
<b>6</b> DUTIES OF THE REFEREE AND ASSISTANT REFEREES.....	<b>141</b>
<b>7</b> DUTIES OF THE SECRETARIAT.....	<b>142</b>
<b>8</b> JUDGING.....	<b>144</b>
<b>9</b> REFEREEING AND JUDGING SYNCHRONISED DIVING.....	<b>147</b>
<b>10</b> SUMMARY OF THE PENALTIES.....	<b>148</b>
<b>11</b> DIVING AT THE WORLD AQUATICS CHAMPIONSHIPS AND OLYMPIC GAMES.....	<b>150</b>
<b>12</b> AGE GROUP RULES - DIVING.....	<b>151</b>
<b>13</b> DIVING FACILITIES AND EQUIPMENT.....	<b>153</b>
<b>14</b> MEDICAL AND SAFETY SPECIFIC REQUIREMENT FOR DIVING.....	<b>159</b>
<b>15</b> APPENDICES.....	<b>162</b>
15.1 APPENDIX 1 - Diagram Diving Facilities.....	163
15.2 APPENDIX 2 - Table Diving Facilities.....	164
15.3 APPENDIX 3 - Diagram Diving Field of Play for Olympic Games and World Championships.....	165
15.4 APPENDIX 4 - Diagram Diving Dry Land Facilities.....	166
15.5 APPENDIX 5 - Diagram Diving Dry Land Facilities Details.....	167
15.6 APPENDIX 6 - Table Diving Dry land Facilities.....	168
15.7 APPENDIX 7 - Equipment in Dry Land Facilities.....	169
15.8 APPENDIX 8 - Springboard.....	170
15.9 APPENDIX 9 - Springboard.....	172
15.10 APPENDIX 10 - Platform.....	175
15.11 APPENDIX 11 - Platform.....	178



## PART FOUR: DIVING RULES

### 1 GENERAL

**1.1** These Rules shall govern all Diving competitions, including Olympic Games, World Aquatics Championships, Diving World Cup, and World Aquatics Junior Championships.

**1.2** All diving installations, including the springboards and platforms, shall be in accordance with the World Aquatics Diving Facilities Rules, inspected and approved by the Delegate of World Aquatics no later than 120 days prior to the start of the competitions.

**1.3** When Diving is sharing the same venue with any other sport, all diving installations shall be available for use by entered diving competitors on competition days provided no competition is in progress.

**1.4** Divers younger than 14 years on December 31st in the year of the competition shall not be permitted to compete at the Olympic Games, World Aquatics Championships or Diving World Cups.

#### 1.5 Diving Number Designations

**1.5.1** All dives shall be designated by a system of 3 or 4 numerals followed by a single letter.

**1.5.2** The first digit shall indicate the group to which the dive belongs:

1 = Front	2 = Back	3 = Reverse	4 = Inward	5 = Twisting	6 = Armstand
-----------	----------	-------------	------------	--------------	--------------

**1.5.3** In the Front, Back, Reverse and Inward groups, a 1 in the second digit indicates that the dive has a flying action during the dive. When there is no flying action the second digit shall be 0.

**1.5.4** The third digit shall indicate the number of half somersaults being performed. For example 1 = ½ somersault, 9 = 4 ½ somersaults, etc. When there are more than 4 ½ somersaults there will be four digits with the third and fourth digits indicating the number of half somersaults. For example 11 = 5 ½ somersaults as 1011.

**1.5.5** In Armstand dives the second digit indicates the group or direction to which the dive belongs:

1 = Front

2 = Back

3 = Reverse

4 = Inward

**1.5.6** In the Twisting group (those dives beginning with the digit 5) the second digit indicates the group or direction of the take-off as listed in Part Four, Article 1.5.2 above.

**1.5.7** In the Twisting and Armstand groups the fourth digit shall indicate the number of half twists being performed.

**1.5.8** The letter at the end of the dive number shall indicate the position in which the dive is performed:

A = Straight

B = Pike

C = Tuck

D = Free

**1.5.9** Free position means any combination of the other positions and is restricted in its use in some twisting dives.

#### 1.6 Degree of Difficulty

**1.6.1** The degree of difficulty of each dive is calculated using the following formula (the component values of the formula are outlined in Part Four, Article 15 (Appendices 8 and 10):

$$\mathbf{A + B + C + D + E = DEGREE OF DIFFICULTY}$$

**1.6.2** As a guide, dives with their numbers and degrees of difficulty for springboard dives have been calculated and are tabled in Part Four, Article 15 (Appendix 9). Platform dives are tabled in Part Four, Article 15 (Appendix 11).





- 1.6.3** Any dive, which is not tabled in Part Four, Appendix 9 or 11 but is used in a competition, shall be given the dive number and degree of difficulty as determined in accordance with Part Four, Articles 1.5 and 1.6.
- 1.6.4** In calculating the degree of difficulty for dives with twists, the following need to be noted:
- Dives with ½ somersault and twists can only be executed in position A,B or C,
  - Dives with 1 or 1 ½ somersaults and twists can only be executed in position D,
  - Dives with 2 or more somersaults and twists can only be executed in position B or C,
  - Armstand dives with 1, 1 ½, or 2 somersaults and one or more twists can only be executed in position D, and
  - Armstand dives with 2 ½ or more somersaults and twists can only be executed in position B or C.
- 1.6.5** The Appendixes 8, 9, 10 and 11 are established by the World Aquatics Technical Diving Committee (TDC) and approved by the World Aquatics Bureau.

## **2 COMPETITIONS**

### **2.1 General**

- 2.1.1** The order of diving shall be determined by a random draw prior to all preliminary competitions. The draw shall be held at the Technical Meeting prior to the preliminary competition. When available, an electronic draw shall be used.
- 2.1.2** At the World Aquatics Championships where there are more than 35 divers entered in a preliminary competition, it may be split into two preliminaries.
- 2.1.3** In the semi-finals, the divers shall compete in reverse order of their ranking determined by the total scores at the end of the preliminary competition. In the case of a tie, the dive order shall be determined by a draw between the affected divers.
- 2.1.4** In the final competition, except where a tournament system is used, the divers shall compete in the reverse order of their ranking determined by the total scores at the end of the semi-final competition. In the case of a tie, the order shall be determined by a draw between the affected divers.
- 2.1.5** When the tournament system is used, the divers shall compete in all remaining sessions of the competition in the reverse order of their ranking determined by the total scores at the end of the preliminary competition. In the case of a tie, the order shall be determined by a draw between the affected divers. When there is a tie for the last position both divers will dive in the same semi-final.
- 2.1.6** The total number of dives executed in one session shall not exceed 210. In that case the session shall be divided into two or more sessions unless a double panel system is used.
- 2.1.7** If a diver is unable to compete at the beginning of any session, the diver ranked next shall advance to the next session, in order to have the prescribed number of divers in each session.
- 2.1.8** When two or more divers score the same number of points, a tie shall be declared for that particular place.
- 2.1.9** In the individual events, the diver with the highest total points shall be declared the winner of that event. The remaining divers shall be ranked by their final points.
- 2.1.10** In the synchronised and team events, the team with the highest total points shall be declared the winner of that event. The remaining teams shall be ranked by their final points.

**The procedure for protests is outlined in Part One, 13.1.**

### **2.2 1 metre springboard**

- 2.2.1** At the World Aquatics Championships there shall be a preliminary and final competition.
- 2.2.2** The final shall comprise the top twelve (12) ranked divers from the preliminary competition.

### **2.3 3 metre springboard and 10 metre platform**

- 2.3.1** At the Olympic Games and World Aquatics Championships there shall always be a preliminary, a semi-final, and a final competition.
- 2.3.2** The semi-final shall comprise the top eighteen (18) ranked divers from the preliminary competition and the final shall comprise the top twelve (12) ranked divers from the semi-final.
- 2.3.3** The preliminary, semi-final, and final competition are separate events, each starting from zero (0) points.

**2.4 Synchronised Diving – 3 metre springboard and 10 metre platform**

**2.4.1** The Olympic Games shall be a direct final competition, with the divers competing in reverse order of their finish in the qualification process.

**2.4.2** In the case of the Olympic Games, if pre-qualification of the number of teams is required, competitions may be held separately and in advance at different venues to establish the teams that qualify.

**2.4.3** The World Aquatics Championships shall be a preliminary and a final competition.

**2.4.4** At the World Aquatics Championships, the final shall be the top eight (8) teams from the preliminary competition.

**2.4.5** The preliminary and final competitions are separate events, each starting from zero (0) points.

**2.5 Mixed Team Event – 3 metre springboard and 10 metre platform combined**

There shall be a direct final.

**2.6 Mixed Synchronised Diving – 3 metre springboard and 10 metre platform**

There shall be a direct final.

**3 COMPETITION FORMAT**

**3.1** All individual and synchronised diving competitions for men shall comprise six (6) dives.

**3.2** All individual and synchronised diving competitions for women shall comprise five (5) dives.

**3.3** No dive of the same number shall be repeated within each six (6) or five (5) dives.

**3.4 1 metre and 3 metre springboard – men and women**

**3.4.1** The Women's springboard competitions shall comprise five (5) dives from five (5) different groups without limit of degree of difficulty.

**3.4.2** The Men's springboard competitions shall comprise six (6) dives from five (5) different groups without limit of degree of difficulty.

**3.5 Platform – men and women**

**3.5.1** The Women's platform competitions shall comprise five (5) dives from five (5) different groups without limit of degree of difficulty.

**3.5.2** The Men's platform competitions shall comprise six (6) dives from six (6) different groups without limit of degree of difficulty.

**3.5.3** At all World Aquatics competitions (Olympic Games, World Aquatics Championships, Diving World Cups and other World Aquatics events, other than Age group competitions), only dives from the 10 metre platform may be executed.

**3.6 Synchronised diving**

**3.6.1** The synchronised diving competition involves two competitors diving simultaneously from the springboard or platform. The competition is judged on how the two divers individually perform their dives and how the two divers as a team synchronise their performance.

**3.6.2** At Olympic Games and all World Aquatics Events the teams shall comprise two competitors of the same Federation.

**3.6.3** Every competition for women and for mixed synchro on 3m springboard and platform shall comprise five (5) rounds of dives from five (5) different groups. The first two (2) rounds of dives with an assigned degree of difficulty of 2.0 for each dive regardless of the formula and three (3) rounds of dives without limit of degree of difficulty. All forward facing dives on springboard shall be done with a running approach.

**3.6.4** Every competition for men on 3m springboard and platform shall comprise six (6) rounds of dives from five (5) different groups. The first two (2) rounds of dives with an assigned degree of difficulty of 2.0 for each dive regardless of the formula and four (4) rounds of dives without limit of degree of difficulty. All forward facing dives on springboard shall be done with a running approach.



**3.6.5** In each round the two divers must perform the same dive (same dive number and same position).

**3.7 Mixed Team Event**

**3.7.1** The Mixed Team Event consist of at least one female and one male diver but no more than four (4) divers.

**3.7.2** At all World Aquatics Events the teams shall comprise competitors of the same Federation.

**3.7.3** Every competition shall comprise six (6) different dives without limit of degree of difficulty from six (6) different groups.

**3.7.4** Two (2) dives shall be executed by the female competitor and two (2) dives by the male competitor. Two (2) dives shall be executed by a mixed synchronised team of one male and one female diver. Three (3) dives shall be executed from the 3m springboard and the other three (3) dives from the 10m platform.

**3.7.5** In the Mixed Team Event the following rounds will be performed.

Round 1	Dive 1	3m springboard	Female
	Dive 2	3m springboard	Male
Round 2	Dive 3	3m springboard	Mixed Synchronised
Round 3	Dive 4	10m platform	Female
	Dive 5	10m platform	Male
Round 4	Dive 6	10m platform	Mixed Synchronised

There are 4 rounds with 6 dives and in 2 of the rounds, a female and male diver each do a dive for a federation.

**3.8 Mixed Synchronised diving**

**3.8.1** At the World Aquatics Championships, Diving World Cups and other World Aquatics Diving Events additional Mixed Synchronised Diving Events can be conducted.

**3.8.2** At all World Aquatics Events the teams shall comprise two (2) divers [one (1) male and one (1) female] of the same Federation.

**3.8.3** Every competition for Mixed Synchronised on 3m springboard and 10m platform shall comprise five (5) rounds of dives from five (5) groups.

**3.8.4** The first two (2) rounds of dives with an assigned degree of difficulty of 2.0 regardless of the formula and three (3) rounds of dives without limit of degree of difficulty.

**4 STATEMENT OF DIVES**

**4.1** Each diver, or diver's representative, shall deliver to the Referee, or their designated representative, a complete statement of the selected dives on the official form of the event for the preliminary competition and all the following sessions of the competition.

**4.2** The diver and the diver's representative are responsible for the accuracy of the statement in the list and the statement of dives shall be signed by the diver and the diver's representative.

**4.3** The statement of dives shall be submitted no later than 24 hours before the commencement of the preliminary competition in each event.

**4.4** The Referee may accept any statement of dives submitted after the 24 hour deadline, up to three (3) hours prior to the commencement of the preliminary competition, provided it is accompanied by a fee equivalent of two-hundred fifty (250) Swiss Francs.

**4.5** Unless the statement is presented within the time prescribed, a diver shall not be admitted to the competition.

**4.6** In all competitions, the diver or the diver's representative may change the statement of dives before the commencement of any semi-final or final of the competition, provided the amended statement is lodged with the Referee, or their designated representative, no later than thirty (30) minutes after the end of the previous session of the competition. If a new statement of dives is not submitted within the prescribed time, the diver shall perform the dives as indicated in the previous submission.



- 4.7** In any competition, (individual or synchronised), a diver may be replaced by another diver of the same Federation up to two (2) hours before the commencement of the preliminary competition. An official substitution form must be submitted and signed by the diver, coach and Referee. In synchronised diving events at the Olympic Games or events that only have a direct final the replacement may also take place up to two (2) hours before the commencement of the final competition. The Referee will accept a change in the statement of dives.
- 4.7.1** In exceptional circumstances, as approved by the TDC Commission or its delegate, a diver may be replaced by another entered diver of the same Federation up to thirty (30) minutes before the commencement of a competition for synchronised or team events. If there is no delegate, the Referee may approve. An official substitution form must be submitted together with evidence to support the exceptional circumstance and signed by the diver, coach and Referee. The Referee will accept a change in the statement of dives, if approved.
- 4.8** In individual, synchronised and team events, when the closing times have passed (see Part Four, Article 4.3 and 4.4), no change may be made to the statement of dives.
- 4.9** The statement of dives shall contain the following information in the order of execution of the dives:
- The number of each dive according to Part Four, Article 1.5.1 to 1.5.7
  - The position of the dive according to Part Four, Article 1.5.8
  - The height of the board or platform
  - The degree of difficulty as determined by the Formula described in Part Four, Article 1.6.
- 4.10** The dives in each round shall be executed by all the divers consecutively, according to the starting order.
- 4.11** The statement of dives shall take precedence over the indicator board and any announcement.

## **5 COMPETITION PROCEDURE**

### **5.1 Control of Competition**

- 5.1.1** Every competition shall be controlled by a Referee, and in some cases supported by Assistant Referees, together with Judges and a Secretariat.
- 5.1.2** The number and the position of the dive to be performed shall be displayed on an indicator board visible to both divers and judges.
- 5.1.3** Where possible a computer shall be used with the capability to run a competition and to produce a judging analysis.
- 5.1.4** When electronic scoring equipment is not available the judges must have flash cards to display their awards. These flash cards must be capable of showing awards from 0 to 10 by half points.

### **5.2 Composition of the Judges Panels**

- 5.2.1** Whenever possible at the Olympic Games, World Aquatics Championships and Diving World Cups, seven (7) judges shall be used for individual and team events and eleven (11) judges for synchronised diving events. For synchronised diving, where eleven (11) judges are used, five (5) shall judge synchronisation of the dive, three (3) shall judge the execution of one diver and three (3) the execution of the other diver.
- 5.2.2** In all individual and team competitions other than the Olympic Games, World Aquatics Championships and Diving World Cups, five (5) judges may be used. In all synchronized diving competitions, other than Olympic Games, World Aquatics Championships and Diving World Cups, nine (9) judges may be used. Five (5) shall judge the synchronisation of the dive, two (2) shall judge the execution of one diver and two (2) the execution of the other diver.
- 5.2.3** Provided sufficient judges are available, the panel of judges for the final competition may consist of judges whose nationality is different to that of any of the divers in the competition.
- 5.2.4** When considered suitable, double panels of judges may be used in the same event. If double panels are used, the second panel is introduced in the fourth round of the competition. Note: In exceptional circumstances, such as high heat and humidity, the panels may be changed after the end of any round.
- 5.2.5** The Referee shall place the judges on each side of the springboard or platform in use, as outlined in Part Four, Article 15.3 (Appendix 3). When this is not practical, the judges may be placed together on one side.



- 5.2.6** Once placed, a judge shall not change position unless at the discretion of the Referee, and then only in exceptional circumstances.
- 5.2.7** When a judge is unable to continue to function after a competition has started, they shall be replaced by the reserve judge.
- 5.2.8** After each dive, on a signal given by the Referee, each judge shall immediately and simultaneously, without communicating with one another, and in a distinct manner, indicate the award for the dive. When an electronic judging device is used, the judges shall enter their awards into their electronic score pads immediately after the performance of the dive.
- 5.2.9** The judges' awards shall be displayed on the electronic scoreboard, preferably unseen by the judges. The awards (without any other information about the standing of the competition) must be seen by the judges on their electronic score pads.

## **6 DUTIES OF THE REFEREE AND ASSISTANT REFEREES**

- 6.1** The Referee shall be in control of the competition and located in a position so that they can manage the competition and ensure that the Rules are observed.
- 6.2 The Assistant Referees:**
- shall observe the diver(s) on the platform (if no camera is available),
  - in synchronised diving, will be positioned on the opposite side of the pool to observe the performance of the diver on that side.
- 6.3 Duties of the Referee before the competition**
- 6.3.1** The Referee shall inspect the statements of dives. If the statement does not comply with the Rules, the Referee shall have it corrected before the beginning of the competition.
- 6.3.2** The diver, or the diver's representative, shall be informed of the Referee's decision, that a correction is required, as soon as possible.
- 6.4 Duties of the Referee during the competition**
- 6.4.1** In the case of unforeseen circumstances, the Referee may declare a short break, a postponement, or a discontinuation of the competition. If possible, the break should be done after a full round of dives.
- 6.4.2** Following an interruption, the competition shall be continued from where it was stopped. The points scored before the interruption shall be carried forward into the remaining portion of the competition, whenever it is held. The final results must be based on the last complete round of dives.
- NOTE: If the competition cannot be continued, the result will be determined by the Jury of Appeal.*
- 6.4.3** When there is a strong wind, the Referee may give a diver the right to make a re-start without deduction of points.
- 6.4.4** Before each dive, the Referee or the official announcer shall announce in the language of the host country the name of the diver and the dive to be executed. In competitions where different platforms are used the height of the platform shall also be announced. If a scoreboard is used, all information concerning the dive shall be displayed and the announcement may be restricted to the identification of the diver.
- 6.4.5** When a dive is incorrectly announced, the diver or their representative shall advise the Referee immediately, who shall then confirm the diver's statement of dives.
- 6.4.6** If the incorrectly announced dive is executed by the diver, the Referee may cancel it and have the correct dive announced and performed immediately. The awards for the first dive must be noted should a protest be lodged.
- 6.4.7** The dive shall be executed after a signal given by the Referee. The signal shall not be given before the diver has assumed their position on the board or platform and the Referee has checked the indicator board. For backward and inward take-offs, the diver shall not proceed to the end of the springboard or platform until after the signal has been given by the Referee.
- 6.4.8** Each diver shall be given sufficient time for the preparation and execution of the dive, but if it takes more than one minute after the Referee has given a warning, the diver shall receive zero (O) points for the dive announced.
- 6.4.9** When a diver executes a dive before the signal is given, the Referee shall decide whether the dive shall be repeated.



- 6.4.10** In exceptional circumstances, the Referee may allow a diver to repeat a Dive without penalty. The awards for the first dive must be noted should a protest be lodged.
- 6.4.11** The request for such a repetition must be made immediately by the diver or their representative.
- 6.4.12** When the Referee is certain that a diver has performed a dive of a number other than that announced, the Referee shall declare it a failed dive.
- 6.4.13** When it is quite clear that the dive has been performed in a position other than that announced, the Referee shall repeat the announcement, and declare that the maximum award shall be 2 points, before giving the judges the signal to show their marks. If a judge then awards more than 2 points, the Referee shall declare the award from that judge to be 2 points.
- 6.4.14** During the execution of a dive, there shall be no assistance to the diver from any person. Assistance between dives shall be permitted.
- 6.4.15** The Referee may declare a dive to be failed if they consider that assistance has been given by anyone to the diver after starting signal.
- 6.4.16** When a diver refuses to execute a dive, the Referee shall declare a failed dive.
- 6.4.17** If a diver in a competition disturbs a contest, the Referee may exclude them from that competition. If a member of a team, a coach or an official disturbs a contest, the Referee may exclude that person from the competition area.
- 6.4.18** The Referee may remove any judge from the competition whose judgement they regard as unsatisfactory and may appoint another judge to replace them. At the end of the competition the Referee shall make a written report to the Jury of Appeal.
- 6.4.19** Such a change of judge shall take place only at the end of a session or round of dives performed by each diver.
- 6.5** **Duties of the Referee during the dive**
- 6.5.1** On the springboard or the platform when a diver in a running dive takes a step and stops or in a standing dive stops the movement for the take-off after the legs have commenced to press, the Referee shall declare a re-start and that 2 points are to be deducted from each judge's awards.
- 6.5.2** When there is a restart in a running, standing, or armstand dive, the Referee shall deduct 2 points from the award of each judge.
- 6.5.3** When a second attempt (a re-start) is unsuccessful, the Referee shall declare a failed dive.
- 6.5.4** If the diver double bounces during the approach or on the end of the springboard, or double jumps on the end of the platform, before the take-off, the Referee shall declare it a failed dive.
- 6.5.5** *Note: Double bounce or double jump: Two consecutive jumps from both feet, where the feet leave the springboard or platform, When in a running dive the final step is not from one foot, the Referee shall declare it a failed dive.*
- 6.5.6** When the take-off from the springboard or the platform is not from both feet simultaneously, the Referee shall declare it a failed dive.
- 6.5.7** When at the entry a twist is greater or less than that announced by 90 degrees or more, the Referee shall declare it a failed dive.
- 6.5.8** When one or both arms are held above the head in a feet first entry or below the head in a head first entry, the Referee shall declare the maximum award to be 4½ points. If a judge then awards more than 4½ points, the Referee shall declare the award from that judge to be 4½ points.
- 6.5.9** In head first dives, if the feet enter the water before the head or hands, the Referee shall declare it a failed dive.
- 6.5.10** In feet first dives, if the head or hands enter the water before the feet, the Referee shall declare it a failed dive.
- 6.6** **Duties of the Referee after the competition**
- 6.6.1** At the end of the competition the Referee shall confirm the final results by their signature.

## **7** **DUTIES OF THE SECRETARIAT**



- 7.1** The records of the competitions shall be kept by two independent secretaries.
- 7.2** In order to facilitate the scoring, a computer, a rapid calculator, or a chart may be used.
- 7.3** In individual and team events, the judges' awards shall be announced in their seating order, and the first secretary shall record all awards as announced on the diver's statement of dives. In synchronised diving events, the judges awards shall be announced, starting with the execution judges awards in seating order, followed by the synchronised judges awards, also in seating order. When a computer and a scoreboard are used, the announcement of the judges awards is not necessary and the secretary may record the awards directly from the monitor.
- 7.4** The second secretary shall enter on the diver's statement of dives the judges' awards. When a computer is used to determine the scores, the second secretary may record the awards directly from the monitor.
- 7.5** In the individual and team events, when seven (7) judges are used, the secretaries shall cancel the two (2) highest and the two (2) lowest judges' awards. When more than two (2) awards are equal only two of the equal awards shall be cancelled. If only five (5) judges are used, the secretaries shall cancel the highest and the lowest award.
- 7.6** In synchronised diving, when eleven (11) judges are used, the secretaries shall cancel the highest and the lowest judges' awards given for execution for one diver, the highest and lowest judges' awards for execution of the other diver and the highest and lowest judges' awards given for synchronisation. When more than two (2) awards are equal only two of the equal awards may be cancelled.
- 7.7** In synchronised diving, when nine (9) judges are used, the secretaries shall cancel the highest and the lowest judges' awards given for execution and the highest and lowest judges' awards given for synchronisation. When two (2) or more awards are equal, either of the equal awards may be cancelled.
- 7.8** The secretaries shall independently add the remaining awards and multiply this total by the degree of difficulty for the dive to determine the score of the dive according to the following examples:

**Individual and team competitions**

**Five (5) judges:**

8.0, 7.5, 7.5, 7.5, 7.0 =  $22.5 \times 2.0 = 45.0$

**Seven (7) judges:**

8.0, 7.5, 7.5, 7.5, 7.5, 7.5, 7.0 =  $22.5 \times 2.0 = 45.0$

**Synchronised Diving competitions**

**Nine (9) judges:**

Execution diver 1: 7.0, 6.5

Execution diver 2: 5.5, 5.5

Synchro awards: 8.5, 8.0, 8.0, 7.5, 7.5 =  $(35.5 \div 5) \times 3 = 21.3 \times 2.8 = 59.64$

**Eleven (11) judges:**

Execution diver 1: 7.0, 6.5, 6.0

Execution diver 2: 5.5, 5.5, 7.0

Synchro awards: 8.0, 8.0, 7.5, 8.0, 7.0 =  $(35.5 \div 5) \times 3 = 21.3 \times 2.8 = 59.64$

- 7.9** When a judge by reason of illness or any other unforeseen circumstances, has made no award for a particular dive, the average of the awards of the other judges shall be adopted as the missing award. The award shall be rounded up or down to the nearest half point or whole point. Averages ending in .01 to .24 shall be lost. Averages ending in .25 to .74 shall be rounded to .50. Averages ending in .75 or higher shall be rounded up to the next whole point.



- 7.10** In synchronised diving, when a judge (execution or synchronised) by reason of illness or any other unforeseen circumstances, has made no award for a particular dive, in an eleven (11) judge panel, the average of the awards of the other two (2) execution judges of the same diver, or the average of the other four synchronised judges, shall be adopted as the missing award. The average award shall be rounded up or down to the nearest half point or whole point. Averages ending in .01 to .24 shall be lost. Averages ending in .25 to .74 shall be rounded to .50. Averages ending in .75 or higher shall be rounded up to the next whole point. In a nine (9) judge panel, the award of the other execution judge of the same diver shall be adopted as the missing award.
- 7.11** At the end of the competition the two secretaries shall collate the score sheets.
- 7.12** The result of the competition shall be obtained from the score sheets.
- 7.13** If an electronic officiating equipment is in use, only one secretariat may be used. The secretariat records the awards and the electronic result only, to make sure that the final result can be calculated in a case that the electronic officiating equipment breaks down.
- 7.14** The final result at World Aquatics events shall be announced in one of the official languages of World Aquatics (English or French).

## **8 JUDGING**

### **8.1 General**

- 8.1.1** A judge shall award from 0 to 10 points for a dive according to their overall impression within the following criteria:

<b>Excellent</b>	10
<b>Very Good</b>	8.5 – 9.5
<b>Good</b>	7.0 – 8.0
<b>Satisfactory</b>	5.0 – 6.5
<b>Deficient</b>	2.5 – 4.5
<b>Very Deficient</b>	0.5 – 2.0
<b>Completely failed</b>	0

- 8.1.2** When judging a dive, the judge must not be influenced by any factor other than the technique and execution of the dive. The dive must be considered without regard to the approach to the starting position, the difficulty of the dive, or any movement beneath the surface of the water.
- 8.1.3** The points to be considered in judging the overall impression of a dive are the technique and grace of:
- the starting position and the approach
  - the take-off
  - the flight
  - the entry
- 8.1.4** When a dive is performed clearly in a position other than that announced the dive shall be deemed unsatisfactory. The highest award for such a dive is 2 points.
- 8.1.5** When a dive is performed partially in a position other than that announced, each judge shall deduct according to their opinion.
- 8.1.6** When a dive is not performed in the straight (A), pike (B), tuck (C), or free (D) position as described, the judge shall deduct from ½ to 2 points, according to their opinion.
- 8.1.7** When a judge considers that a dive of a different number has been performed, they may award zero (0) points, notwithstanding that the Referee has not declared it to be a failed dive.

### **8.2 The starting position**

- 8.2.1** When the signal is given by the Referee, the diver shall take the starting position.





- 8.2.2** In the starting position the body shall be straight, head erect, with the arms straight in any position.
- 8.2.3** When the body in the starting position is not straight, head erect, with the arms straight in any position, each judge shall deduct ½ to 2 points, according to their opinion.
- 8.2.4** **Standing dives**
- 8.2.4.1** The starting position in standing dives shall be assumed when the diver stands on the front end of the springboard or platform.
- 8.2.4.2** When executing a standing dive, the feet must stay in contact with the springboard or platform until the take-off.
- 8.2.4.3** If the feet leave the springboard or platform before the take-off, the judge shall deduct from ½ to 2 points, according to their opinion.
- 8.2.5** **Running dives**
- 8.2.5.1** The starting position in a running dive shall be assumed when the diver is ready to take the first step of the run.
- 8.2.6** **Armstand dives**
- 8.2.6.1** The starting position in an armstand dive shall be assumed when both hands are on the front end of the platform and both feet are off the platform.
- 8.2.6.2** When, in an armstand dive, a stationary and steady balance in the straight vertical position is not shown, or if the hands lose contact with the platform during the take-off, each judge shall deduct from 0.5 to 2 points, according to their opinion.
- 8.2.6.3** A re-start shall be permitted when:
- a diver loses their balance and moves one or both hands from the original position at the front end of the platform, or
  - when one or both feet return to the platform, or
  - when one or any part of their body other than their hands touch the platform.
- The Referee shall declare a restart and 2 points are to be deduct from each judge's award.
- 8.2.6.4** When, in an armstand dive, the hands lose contact with the platform during the take-off, each judge shall deduct from 0.5 to 2 points, according to their opinion.
- 8.3** **The approach**
- 8.3.1** When executing a running dive from either the springboard or the platform, the run shall be smooth, aesthetically pleasing, and in a forward direction to the end of the springboard or platform with the final step being from one foot.
- 8.3.2** When the run is not smooth, aesthetically pleasing, or in a forward direction to the end of the springboard or platform, each judge shall deduct ½ to 2 points, according to their opinion.
- 8.3.3** When the final step is not from one foot, the judge may award zero (0) points, notwithstanding that the Referee has not declared it to be a failed dive.
- 8.3.4** When the judge considers that the diver has double bounced or double jumped in performing a dive, the judge may award zero (0) points, notwithstanding that the Referee has not declared it to be a failed dive.
- NOTE: Double bounce or double jump: Two consecutive jumps from both feet where the feet leave the springboard or platform.*
- 8.4** **The take-off**
- 8.4.1** From the springboard, the take-off in forward and reverse dives may be performed either standing or running at the option of the diver. The take-off in backward and inward dives must be performed standing. .
- 8.4.2** From the platform, the take-off in forward dives may be performed either standing or running at the option of the diver. The take-off in backward, reverse and inward dives must be performed standing.



- 8.4.3** The take-off from the springboard and the platform shall be from both feet simultaneously. The reverse take-off from the platform may be from one foot.
- 8.4.4** When the take-off from the springboard or the platform is not from both feet, the judge may award zero (0) points, notwithstanding that the Referee has not declared it to be a failed dive.
- 8.4.5** In running and standing dives, the take-off shall be, balanced and high and shall be from the end of the springboard or platform.
- 8.4.6** When the take-off is not balanced and high, or from the end of the springboard or platform, each judge shall deduct ½ to 2 points, according to their opinion.
- 8.4.7** In dives with twist, the twisting shall not be manifestly done from the springboard or platform. If the twisting is manifestly done from the springboard or platform, each judge shall deduct ½ to 2 points, according to their opinion.

## **8.5 The flight**

- 8.5.1** During the execution of a dive the dive shall be in the direct line of flight.
- 8.5.2** If during the execution of a dive a diver dives to the side of the direct line of flight, each judge shall deduct according to their opinion.
- 8.5.3** If during the execution of a dive, a diver touches the end of the springboard or platform with their feet or hands, each judge shall deduct according to their opinion.
- 8.5.4** If during the execution of a dive, where approved visual technology is unavailable, a judge considers a diver to be unsafely close to the springboard or platform or the diver touches the end of the springboard or platform with their head, the judges shall award up to a maximum of 2 points. If most of the judges (at least three (3) in a 5 judge panel / at least four (4) in a 7 judge panel) award two (2) or less points for an unsafe dive, all higher scores shall be two (2) points. The judges shall indicate to the Referee using electronic technology or where electronic technology is not available by raising one hand that the two (2) or less points are in relation to the unsafely close execution of the dive. Where approved visual technology is available, the Referee should review and if an unsafe dive has been performed the Referee shall declare a maximum of two (2) points from each judge's award..

The dive can be executed in the following positions:

### **Straight (A)**

- 8.5.5** In the straight position the body shall not be bent either at the knees or hips. The feet shall be together and the toes pointed. The position of the arms is at the option of the diver.
- 8.5.6** Should the straight position not be aesthetically pleasing and shown as described, each judge shall deduct from ½ to 2 points, according to their opinion.
- 8.5.7** In all flying dives a straight position shall be clearly shown and that position shall be assumed from the take off or after one somersault. When the straight position is not shown for at least one quarter of a somersault (90°) in dives with one (1) somersault, and at least one half of a somersault (180°) in dives with more than one (1) somersault, the maximum award by the judges shall be 4½ points.

### **Pike (B)**

- 8.5.8** In the pike position the body shall be bent at the hips, but the legs must be kept straight at the knees, the feet shall be together, and the toes pointed. The position of the arms is at the option of the diver.
- 8.5.9** Should the pike position not be aesthetically pleasing and shown as described, each judge shall deduct from ½ to 2 points, according to their opinion.
- 8.5.10** In the pike dives with twist, the pike position must be clearly shown. Should this position not be shown, each judge shall deduct ½ to 2 points, according to their opinion.





*These diving illustrations serve as a guide only and the position of the arms is at the choice of the diver except in the entry.*

**Tuck (C)**

- 8.5.11** In the tuck position the body shall be compact, bent at the knees and hips with the knees and feet close together within the bodyline of the shoulders. The hands shall be on the lower legs and the toes pointed.

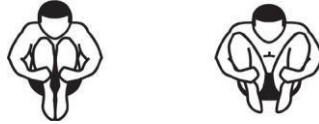

- 8.5.12** Should the tuck position not be aesthetically pleasing and shown as described, each judge shall deduct from  $\frac{1}{2}$  to 2 points, according to their opinion.

- 8.5.13** In tuck dives with twist, the tuck position must be clearly shown. Should this position not be shown, each judge shall deduct  $\frac{1}{2}$  to 2 points, according to their opinion.



*These diving illustrations serve as a guide only and the position of the arms is at the choice of the diver except in the case of the hands in the tuck and the entry.*

**Free position (D)**

- 8.5.14** In the free position, the body position is optional (A, B or C) but the legs shall be together and the toes pointed.
- 8.5.15** Should the free position not be shown as described, each judge shall deduct from  $\frac{1}{2}$  to 2 points, according to their opinion.
- 8.5.16** In somersault dives with twist, the twist may be performed at any time during the flight.

**8.6 The entry**

- 8.6.1** The entry into the water shall in all cases be vertical, not twisted, with the body straight, the feet together, and the toes pointed.
- 8.6.2** When the entry is short or over, twisted or the body not straight, the feet not together, and the toes not pointed, each judge shall deduct according to their opinion.
- 8.6.3** In head first entries, the arms shall be stretched beyond the head and in line with the body, with the hands close together. If one or both arms are held below the head on entry, the judge may award up to  $4 \frac{1}{2}$  points, notwithstanding that the Referee has not declared a maximum award of  $4 \frac{1}{2}$ .
- 8.6.4** In feet first entries, the arms shall be close to the body with no bending at the elbows. If one or both arms are held beyond the head on entry, the judge may award up to  $4 \frac{1}{2}$  points, notwithstanding that the Referee has not declared a maximum award of  $4 \frac{1}{2}$ .
- 8.6.5** Other than as provided in Rules IV.8.6.3 and IV.8.6.4, when the arms are not in the correct position in either the head first or feet first entry, each judge shall deduct from  $\frac{1}{2}$  to 2 points, according to their opinion.
- 8.6.6** When at the entry a twist is greater or less than that announced by 90 degrees or more, the judge may award zero (O) points, notwithstanding that the Referee has not declared it to be a failed dive.
- 8.6.7** The dive is considered to have been completed when the whole of the body is completely under the surface of the water.

**9 REFEREEING AND JUDGING SYNCHRONISED DIVING**

- 9.1** Synchronised diving is judged by the execution of the individual dives and the synchronisation of the divers.
- 9.2** The rules for judging individual diving shall apply except where otherwise stated in these rules.



- 9.3** When judging the synchronisation of the dives, the overall impression of the synchronisation of the dives must be taken into account.
- 9.4** When one or both divers perform a dive of a different number or position, other than that announced, the Referee shall declare it a failed dive.
- 9.5** The factors to be considered in judging synchronised diving are:
- the starting position, the approach and the take-off, including the similarity of the height,
  - the coordinated timing of the movements during the flight,
  - the similarity of the vertical angles of the entries,
  - the comparative distance from the springboard or platform of the entry,
  - the coordinated timing of the entries.
- 9.6** If either diver enters the surface of the water before the other diver leaves the springboard or platform, the Referee shall declare it a failed dive.
- 9.7** The Referee shall declare a two-point deduction from all judges when there is a re- start by one or both divers.
- 9.8** The execution judges must not be influenced by any factor other than the technique and execution of the dive, not both dives, nor the synchronisation of the divers.
- 9.9** When an execution judge considers that a dive of a different number or position has been performed by a diver, the judge shall award zero (0) points notwithstanding that the Referee has not declared it to be a failed dive. If both execution judges of one diver in a nine (9) judge panel or all three (3) execution judges in an eleven (11) judge panel, award zero (0) points, the Referee shall declare it a failed dive. If the Referee declares a failed dive, zero (0) points are awarded by all nine (9) or eleven (11) judges.
- 9.10** The synchronisation judges must not be influenced by any other factor other than the coordinated performance of the two divers and not the execution of both dives.
- 9.11** If all the synchronisation judges award zero (0) points, the Referee shall declare it a failed dive.
- 9.12** When any of the following faults are shown, each synchronisation judge shall deduct from ½ to 2 points, according to their opinion, for the lack of:
- similarity of the starting position, approach, take-off or height,
  - coordinated timing of the movement during the flight,
  - similarity of the vertical angles of the entries,
  - comparative distance from the springboard or platform of the entry,
  - coordinated timing of the entries.
- 9.13** In synchronised diving all forward facing dives on the springboard must be performed with a running approach (see Part Four, Article 3.6.3 and 3.6.4). If a forward facing dive is not performed with a running approach in a springboard synchronised diving competition, the Referee shall declare it a failed dive. .

## **10 SUMMARY OF THE PENALTIES**

- 10.1 Referee to declare "Failed Dive": 0 points** ( as per Part Four, Article:)



<b>6.4.8</b>	If the diver takes more than one minute, after a warning.
<b>6.5.4</b>	If a diver double bounces on the end of the springboard or double jumps on the end of the platform before take-off.
<b>6.5.5</b>	If the final step is not from one foot.
<b>6.5.6</b>	If the take-off on the springboard or the platform is not from both feet simultaneously.
<b>6.5.7</b>	If a twist is greater or less than that announced by 90 degrees or more.
<b>6.4.12</b>	If a diver has performed a dive of a number other than that announced.
<b>6.5.8.1</b>	If the feet enter the water before the head or hands in a head first dive.
<b>6.5.8.2</b>	If the head or hands enter the water before the feet in a feet first dive.
<b>6.4.15</b>	If assistance has been given to the diver after the starting signal.
<b>6.5.3</b>	When a second attempt (a re-start) is unsuccessful.
<b>6.4.16</b>	If a diver refuses the execution of a dive.
<b>9.2</b>	In synchronised diving if a diver, or both divers, perform a dive of a different number or position.
<b>9.5</b>	In synchronised diving if either diver enters the surface of the water before the other diver leaves the springboard or platform.
<b>9.8</b>	In synchronised diving if all execution judges for one diver award zero (O) points
<b>9.10</b>	In synchronised diving if all synchronisation judges award zero (O) points.

**10.2 Referee to declare "2 points deduction" (as per Part Four, Article:)**

<b>6.5.1</b>	If a diver takes a step and stops in a running dive or stops the movement for a standing take-off after the legs have commenced to press.
<b>6.5.2</b>	If there is a re-start in a standing, running, or armstand dive. (see Part Four, Article 8.2.6.2)
<b>9.6</b>	In synchronised diving if there is a re-start by one or both divers.

**10.3 Referee to declare "2 points maximum" (as per Part Four, Article:)**

<b>6.4.13</b>	If a diver performs a dive in a position other than that announced.
---------------	---

**10.4 Referee to declare "4 ½ points maximum" (as per Part Four, Article:)**

<b>6.5.8</b>	If a diver has one or both arms held above the head in a feet first entry or below the head in a head first entry.
--------------	--

**10.5 Judges to award "O points" (as per Part Four, Article:)**

<b>8.1.7</b>	If a dive of a different number has been performed.
<b>8.3.3</b>	If the final step is not from one foot.
<b>8.3.4</b>	If a diver double bounces on the end of the springboard or double jumps on the end of the platform before the take-off.
<b>8.4.3</b>	If the take-off from the springboard or the platform is not from both feet simultaneously.
<b>8.6.6</b>	If a twist is greater or less than that announced by 90° or more.
<b>9.8</b>	If an execution judge considers that a dive of a different number has been performed.

**10.6 Judges to award "2 points maximum" (as per Part Four, Article:)**

<b>8.1.4</b>	If a dive is performed clearly in a position other than that announced.
<b>8.5.4</b>	If in a dive, a diver is unsafely close to the springboard or platform or touches the end of the springboard or platform with their head.

**10.7 Judges to award "4 ½ points maximum" (as per Part Four, Article:)**



<b>8.5.7</b>	If in a flying dive, a straight position is not clearly shown for at least one quarter of a somersault (90°) in dives with somersault and at least a half somersault (180°) in dives with more than 1 somersault.
<b>8.6.3</b>	If the arms are held below the head in a head first entry.
<b>8.6.4</b>	If one or both arms are held above the head in a feet first entry.

**10.8 Judges to deduct "from ½ to 2 points" (as per Part Four, Article:)**

<b>8.1.6</b>	If a dive is not performed in a position as described.
<b>8.2.3</b>	If the starting position is not straight, head erect, with the arms straight in any position.
<b>8.2.4.3</b>	If the feet leave the springboard or platform (crow-hop) before the take-off in a standing dive.
<b>8.2.6.2</b>	If in an armstand dive, a stationary and steady balance in the straight vertical position is not shown.
<b>8.2.6.4</b>	When in an armstand dive, the hands lose contact with the platform during the take-off.
<b>8.3.2</b>	If the run is not smooth, aesthetically pleasing in a forward direction to the end of the springboard or platform.
<b>8.4.5</b>	If the take-off is not bold, high, and confident.
<b>8.4.6</b>	If in a twist dive, the twisting is manifestly done from the springboard or platform.
<b>8.5.6</b>	If the straight position is not shown as described.
<b>8.5.9</b>	If the pike position is not shown as described.
<b>8.5.10</b>	If in a pike dive with twist, the pike position is not clearly shown.
<b>8.5.12</b>	If the tuck position is not shown as described.
<b>8.5.13</b>	If in a tuck dive with twist, the tuck position is not clearly shown.
<b>8.5.15</b>	If the free position is not shown as described.
<b>8.6.5</b>	If the arms are not in the correct position in either the head first or feet first entry.
<b>9.11</b>	In synchronised diving if any of the following are not shown: <ul style="list-style-type: none"> <li>• similarity of the starting position, approach, take-off and height;</li> <li>• coordinated timing of the movement during the flight;</li> <li>• similarity of the vertical angles of the entries;</li> <li>• comparative distance from the springboard or platform of the entry;</li> <li>• coordinated timing of the entries.</li> </ul>

**10.9 Judges to deduct "according to individual opinion" (as per Part Four, Article:)**

<b>8.1.5</b>	If a dive is performed partially in a position other than that announced.
<b>8.5.2</b>	If in a dive, the diver dives to the side of the direct line of flight.
<b>8.5.3</b>	If in a dive, a diver touches the end of the springboard or platform with their feet or hands.
<b>8.6.2</b>	If the entry into the water is not vertical, or nearly so, or twisted with the body not straight, the feet not together, and the toes not pointed.

**11 DIVING AT THE WORLD AQUATICS CHAMPIONSHIPS AND OLYMPIC GAMES**

At the Olympic Games and the World Aquatics Championships, in springboard and platform Diving contests, only dives prescribed by the World Aquatics Rules for Diving shall be executed.

**11.1 Programme of the Olympic Games**

	<b>Men</b>	<b>Women</b>
<b>Springboard</b>	3m	3m
<b>Platform</b>	10m	10m
<b>Synchronised</b>	3m, 10m	3m, 10m

**11.2** Programme of the World Aquatics Championships

	<b>Men</b>	<b>Women</b>	<b>Mixed Team Event</b>
<b>Springboard</b>	1m, 3m	1m, 3m	3m
<b>Platform</b>	10m	10m	10m
<b>Synchronised</b>	3m, 10m	3m, 10m	3m, 10m

**12 AGE GROUP RULES - DIVING**

**12.1** World Aquatics Rules of competition will apply in all age group competitions.

**12.2 Age Categories**

All age group divers remain qualified from the 1st of January to midnight of the following 31st of December in the year of competition.

**12.3 Diving Events**
**12.3.1 Group A**
**12.3.1.1 Age**

16, 17, or 18 years on December 31st of the year of the competition.

**12.3.1.2 Competition Format**
**12.3.1.2.1 Individual Events**
**Girls' Springboard – 1 metre and 3 metre**

This competition shall comprise nine (9) different dives; five (5) dives each selected from a different group, the total degree of difficulty shall not exceed 9.5 for 3 metre events and 9.0 for 1 metre events, and four (4) dives without limit of degree of difficulty, each dive selected from a different group.

**Girls' Platform – 5 metre – 7.5 metre – 10 metre**

This competition shall comprise eight (8) different dives; four (4) dives each selected from a different group, the total degree of difficulty shall not exceed 7.6, and four (4) dives without limit of degree of difficulty, each dive selected from a different group. At least five (5) different groups must be used.

**Boys' Springboard – 1 metre and 3 metre**

This competition shall comprise ten (10) different dives; five (5) dives each selected from a different group, the total degree of difficulty shall not exceed 9.5 for 3 metre events and 9.0 for 1 metre events, and five (5) dives without limit of degree of difficulty, each dive selected from a different group.

**Boys' Platform – 5 metre – 7.5 metre – 10 metre**

This competition shall comprise nine (9) different dives; four (4) dives each selected from a different group, the total degree of difficulty shall not exceed 7.6, and five (5) dives without limit of degree of difficulty, each dive selected from a different group. All six (6) groups must be used.

**12.3.1.2.2 A / B combined**
**Girls' and Boys' Synchronised Diving – 3 metre**

This competition shall comprise five (5) dives; two (2) rounds of dives with an assigned degree of difficulty of 2.0 for each dive regardless of formula, and three (3) rounds of dives without limit of degree of difficulty. The five (5) dives must be selected from at least four (4) different groups.

All forward facing dives on springboard shall be done with a running approach.

**Girls' and Boys' Synchronised Diving – platform (5m, 7.5m, 10m)**

This competition shall comprise five (5) dives; two (2) rounds of dives with an assigned degree of difficulty of 2.0 for each dive regardless of formula, and three (3) rounds of dives without limit of degree of difficulty. The five (5) dives must be selected from at least four (4) different groups.

**Juniors Mixed Team Event**



- The team consists of at least one female and one male diver but no more than four (4) divers.
- In the team there must be at least 1 diver from B group.
- 6 dives are performed in total and must include all 6 groups.
- Event includes 2 individual dives from 3m: one performed by a male diver and one by a female diver.
- The dives are performed without DD limit.
- Event includes 2 individual dives from 5, 7.5 or 10 meter platform height: one performed by a male diver and one by a female diver.
- The dives are performed without DD limit.
- Event includes 2 mixed synchronised dives: one performed from 3m springboard and one from 5, 7.5 or 10 meter platform height.
- The dives are performed without DD limit.

All teams follow the same format in each round (outlined below). In the Mixed Team Event the following rounds will be performed.

<b>Round 1:</b>	female diver from the 3m springboard
<b>Round 2:</b>	male diver from the 3m springboard
<b>Round 3:</b>	mixed synchronised team (1 female and 1 male diver) from the 3m springboard
<b>Round 4:</b>	female diver from 5, 7.5 or 10 meter platform
<b>Round 5:</b>	male diver from 5, 7.5, or 10 meter platform
<b>Round 6:</b>	mixed synchronised team (1 female and 1 male diver) from 5,7.5, or 10 meter platform.

### 12.3.2 Group B

#### 12.3.2.1 Age

14 or 15 years on December 31st of the year of the competition.

#### 12.3.2.2 Competition Format

##### 12.3.2.2.1 Individual Events

#### Girls' Springboard – 1 metre and 3 metre

This competition shall comprise eight (8) different dives; five (5) dives each selected from a different group, the total degree of difficulty shall not exceed 9.5 for 3 metre events and 9.0 for 1 metre events, and three (3) dives without limit of degree of difficulty, each dive selected from a different group.

#### Girls' Platform – 5 metre – 7.5 metre – 10 metre

This competition shall comprise seven (7) different dives; four (4) dives each selected from a different group, the total degree of difficulty shall not exceed 7.6, and three (3) dives without limit of degree of difficulty, each dive selected from a different group. At least five (5) different groups must be used.

#### Boys' Springboard – 1 metre and 3 metre

This competition shall comprise nine (9) different dives; five (5) dives each selected from a different group, the total degree of difficulty shall not exceed 9.5 for 3 metre events and 9.0 for 1 metre events, and four (4) dives without limit of degree of difficulty, each dive selected from a different group.

#### Boys' Platform – 5 metre – 7.5 metre – 10 metre

This competition shall comprise eight (8) different dives; four (4) dives each selected from a different group, the total degree of difficulty shall not exceed 7.6, and four (4) dives without limit of degree of difficulty, each dive selected from a different group. All least five (5) different groups must be used.

### 12.3.3 Group C

#### 12.3.3.1 Age

12 or 13 years on December 31st of the year of the competition.

#### 12.3.3.2 Competition Format

##### 12.3.3.2.1 Individual Events



**Girls' Springboard – 1 metre and 3 metre**

This competition shall comprise seven (7) different dives; five (5) dives each selected from a different group, the total degree of difficulty shall not exceed 9.5 for 3 metre events and 9.0 for 1 metre events, and two (2) dives without limit of degree of difficulty, each dive selected from a different group.

**Girls' Platform – 5 metre or 7.5 metre**

This competition shall comprise six (6) different dives; four (4) dives each selected from a different group, the total degree of difficulty shall not exceed 7.6, and two (2) dives without limit of degree of difficulty, each dive selected from a different group.

**Boys' Springboard – 1 metre and 3 metre**

This competition shall comprise eight (8) different dives; five (5) dives each selected from a different group, the total degree of difficulty shall not exceed 9.5 for 3 metre events and 9.0 for 1 metre events, and three (3) dives without limit of degree of difficulty, each dive selected from a different group.

**Boys' Platform – 5 metre or 7.5 metre**

This competition shall comprise seven (7) different dives; four (4) dives each selected from a different group, the total degree of difficulty shall not exceed 7.6, and three (3) dives without limit of degree of difficulty, each dive selected from a different group.

**12.4 General Rules for World Aquatics Junior Diving Championships**

**12.4.1** World Aquatics Junior Diving Championships shall be conducted every two years in Groups A and B.

**12.4.2** Each Federation is entitled to enter a maximum of two (2) divers in individual events and one (1) team in synchronised diving events.

**12.4.3** Each diver shall only compete in their age group.

**12.4.4** Each diver shall perform a full list of dives as indicated in their age group.

**12.4.5** Each individual diving event shall be a preliminary and final competition, irrespective of the number of entrants and may be conducted in more than one session.

**12.4.5.1** The top twelve (12) divers from the previous session will participate in a final competition performing only dives without limit. The scores of the dives with limit from the previous session will be carried forward and added to the scores in the final competition to determine the top twelve (12) rankings. Any dives used in the limited degree of difficulty section of the preliminary shall not be used in the final. Divers lower than twelfth place will be ranked by their preliminary scores.

**12.4.5.2** When facilities allow, the opportunity for simultaneous preliminary events may be scheduled subject to the approval of the Bureau on recommendation of the Technical Diving Committee.

**12.4.5.3** The program schedule shall be agreed by the Bureau upon recommendation of the Technical Diving Committee.

**12.4.6** Each diver shall only compete in their age group.

**12.4.7** Either five (5) or seven (7) judges shall officiate in the individual events and nine (9) judges in the synchronised diving events. Note: If possible, eleven (11) judges in the synchronised diving events may be used.

**12.4.8** The Championships shall normally be conducted separately and not in conjunction with Swimming, Water Polo or Artistic Swimming.

**12.4.9** The World Aquatics Junior Diving Championships shall be conducted in a minimum period of seven (7) days.

**13 DIVING FACILITIES AND EQUIPMENT****13.1 Diving Facilities****13.1.1 Springboard Diving**

General requirements: Dimensions in metres for all diving facilities as detailed in Diving Diagrams, Part Four, Article 15.1 (Appendix 1) and Part Four, Article 15.2 (Appendix 2), shall be observed.



- 13.1.1.1** The springboards shall be 4.88 metres long and 0.5 metre wide. At all World Aquatics Events, the type of springboard which must have a slip-resistant surface shall be approved by World Aquatics.
- 13.1.1.2** The springboards shall be provided with movable fulcrums easily adjustable by the diver.
- 13.1.1.3** For springboard diving facilities modified or constructed on concrete platforms after 1st October 2013, the following shall be observed.
- 13.1.1.3.1** The vertical distance from the level of the platform, which supports the fulcrum assembly, to the level of the top of the springboard, shall be 0.35 metre.
- 13.1.1.3.2** The distance from the front edge of the fulcrum assembly (which is 0.741 metres in length) to the front edge of the supporting platform, shall be a maximum of 0.44 metre.
- 13.1.1.3.3** If the front edge of the platform projects past this point then the fulcrum assembly and the rear hinge assembly must be moved forward so as to provide for a maximum of 0.44 metres from the front edge of the platform to the front of the fulcrum assembly.
- 13.1.1.3.4** The concrete platform which supports the springboard shall be aligned with the pool wall or project over the pool.
- 13.1.1.4** The minimum distance recommended from the rear to the centre line of the fulcrum shall be in accordance with the recommendation or specification of the springboard manufacturer.
- 13.1.1.5** The springboards shall be installed dead level at the leading edge when the movable fulcrum is in all positions.
- 13.1.1.6** The springboards should be placed on either one or both sides of the platform. For Synchronised Diving, it is required that at least two springboards at the same height shall be placed side by side and no objects should obstruct the visibility in any part of the dive between the divers.

*See Diving Diagrams Part Four, Article 15.1 (Appendix 1) and Part Four, Article 15.2 (Appendix 2).*

- 13.1.1.7** The back and sides of 3m springboards shall be surrounded by handrails with a minimum clearance of 1.0 metres between vertical pairs. The minimum height shall be 1.0 metre, measured from the level of the springboard, and they shall be with at least two horizontal crossbars placed outside the platform.

A solid transparent barrier is also permitted instead of a crossbar.

*See Diagram Part Four, Article 15.1 (Appendix 1)*

**13.1.2 Platform Diving**

- 13.1.2.1** Each platform shall be rigid and horizontal.
- 13.1.2.2** The minimum dimensions of the platform shall be:

PLATFORM	WIDTH	LENGTH
<b>0.6m to 1.0m</b>	1.00m (2.90m preferred)	5.00m
<b>2.6m to 3.0m</b>	1.00m (2.00m preferred)	5.00m
<b>5.0m</b>	2.90m	6.00m
<b>7.5m</b>	2.00m	6.00m
<b>10.0m</b>	3.00m	6.00m

On 10m platforms, with a width of less than 3m, only the handrails on each side for a distance of at least 3.0m back from the front edge of the platform may be shaped as detailed next (see drawing).



It is recommended that an easily removable section of handrail be included for general use, which can be removed for synchronised diving. See Diagram below.

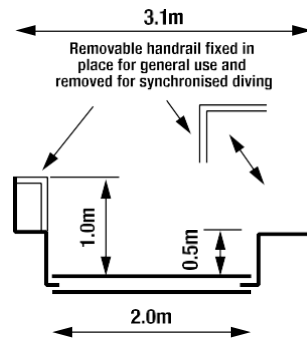

**13.1.2.3** The thickness of the front edge of the platform shall be 0.2 metre but not exceeding 0.3 metre, and can be vertical or inclined at an angle not greater than 10° to the vertical inside the plummet line.

**13.1.2.4** The surface and the front edge of the platform shall be covered throughout with a resilient slip-resistant material. The two surfaces shall be covered separately in order to achieve a clean 90° angle or as described in Part Four, Article 13.1.2.3. The front surface is to be applied first and then the top surface.

The platforms shall be covered in a slip-resistant material that shall have a tread pattern that provides sufficient traction in wet and dry conditions such that the divers are prevented from slipping when performing dives in all directions. The minimum thickness must be 6mm and the colour should give a contrast to the surrounding décor. The material shall be easily cleaned to maintain the slip-resistant feature of the product.

**13.1.2.5** The front edge of the 10 metre platform shall project at least 1.50 metres, the 7.5 metre, 5 metre and 2.6 – 3.0 metre platforms 1.25 metres, and the 0.6 – 1 metre platform 0.75 metre beyond the edge of the pool.

**13.1.2.6** Where a platform is directly underneath another platform the platform above shall project a minimum of 0.75 metre (preferred 1.25 metres) beyond the platform below.

**13.1.2.7** The back and sides of each platform (except 1.0 metre or lower platforms) shall be surrounded by handrails up to 1m from the edge of the platform with a minimum clearance of 1.0 metres between vertical pairs. The minimum height shall be 1.0 metre and they shall be with at least two horizontal crossbars placed outside the platform beginning 1.0 metre from the front edge of the platform.

A solid transparent barrier is also permitted instead of a crossbar.

**13.1.2.8** Each platform shall be accessible by suitable stairs (not ladders) as required by the countries building regulations and or health and safety standards that are applicable.

**13.1.2.9** It is preferable that a platform is not constructed directly under any other platform however in circumstance where this cannot be avoided then you must refer to Part Four, Article 15.1 (Appendix 1) and Part Four, Article 15.2 (Appendix 2).

**13.1.2.10** Requirements for the supporting structure. For platforms and supporting structure of the springboards the design load is  $p = 350$  kiloponds (kilograms force) per lineal metre.

In addition to the static requirements and for the comfort and safety of the user with respect to the movement of the towers, the following limits shall be observed, with respect to the platforms and springboard supports.

Fundamental frequency of platforms is 10.0 Hz.

**TOLERANCES:**

PLATFORM	MINIMUM	MAXIMUM
10m	10 Hz	20 Hz
7.5m, 5m, 3m and 1m	10 Hz	30 Hz

Fundamental frequency of tower 3.5 Hz Total oscillation of total structure  $\pm 2$ mm



The spatial deformation of the front edge of the platforms as a result of  $P_x = P_y = P_z = 100$  kiloponds (kilograms force) shall be a maximum of 1 mm. See Drawing below.

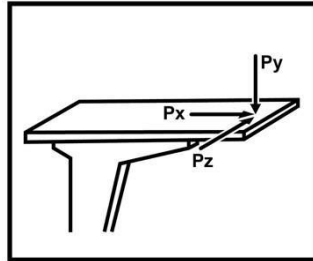

These requirements can be met most adequately by a reinforced concrete structure. Proof of the dynamic behavior is to be obtained together with the static calculations for the whole structure.

### 13.1.3 General Requirements

- 13.1.3.1** Hosts of Olympic Games and World Championships should ensure that the pool depth is a minimum of 5 metres.
- 13.1.3.2** New diving facilities constructed after January 1, 2025 should have a depth of 5 metres under the diving boards in accordance with the Diving Diagrams in the Appendices.
- 13.1.3.3** For pools designed and constructed after 26<sup>th</sup> September 2013 the minimum dimensions in metres for diving facilities as detailed on the Annexes Part Four, Article 15.1 (Appendix 1) and Part Four, Article 15.2 (Appendix 2) shall prevail, using, as a basic measuring point of reference, the plummet line, which is a vertical line extending through the centre of the front edge of the springboard or platform. It is recommended that the preferred dimensions be used for projects considered to have an important status.
- 13.1.3.4** The dimensions C from plummet to adjacent plummet in the tables of Annexes Part Four, Article 15.1 (Appendix 1) and Part Four, Article 15.2 (Appendix 2) apply to platforms with widths as detailed in Part Four, Article 13.1.2.2. If platform widths are increased then the dimensions B and C shall be increased by half the additional widths.
- 13.1.3.5** With regard to dimensions for diving facilities, a combination of preferred and minimum measurements found in Appendices of Part Four, Article 15.1 (Appendix 1) and 15.2 (Appendix 2) shall be used. However, measurements less than minimum are not acceptable.
- 13.1.3.6** The vertical height from the plummet of the diving board and or springboard at rest to the water surface at rest and before water sprays or bubbles are set in motion shall be specified in the Diving Facilities Dimensions table. These measurements should be certified by a surveyor or other qualified officials, appointed or approved by or the member of the country in which the pool is situated.
- 13.1.3.7** The height of the springboards and each platform above the water level may vary by plus 0.05 metre and minus 0.00 metre from the heights prescribed in the Rules.
- 13.1.3.8** The end of 5, 3, and 1 metre platforms must not project beyond the ends of the 3 and 1 metre springboards when they are adjacent to each other.
- 13.1.3.9** In the area of full water depth, the bottom of the pool may rise up to 2%. In the diving pool, the depth of water shall not be less than 1.8 metres at any point.
- 13.1.3.10** In outdoor pools, best practice suggests that springboards and platforms are recommended to face north in the northern hemisphere and south in the southern hemisphere.
- 13.1.3.11** Pool walls shall be vertical and form 90 degree right angles to the surface of the water. They shall be constructed of solid material, with a slip-resistant surface.

The admissible tolerance in walls verticality will be  $\pm 0.3$  degrees.

Rest ledges along the pool walls are permitted; they must be not less than 1.2 metres below the water surface, and may be 0.1 metre to 0.15 metre wide. Only internal rest ledges are permitted.



**13.1.3.12** Mechanical surface agitation shall be installed under the diving facilities to aid the divers in their visual perception of the surface of the water. In pools equipped with an underwater bubble machine, the machine shall only be used for the purpose if it creates sufficient water agitation when working with a very low pressure; otherwise a horizontal water sprinkler system shall only be used.

**13.1.4 Lighting**

**13.1.4.1** The minimum illumination at a level of 1 metre above the water surface shall not be less than 600 lux.

**13.1.4.2** Sources of natural and artificial illumination shall be provided with controls to prevent glare.

**13.1.5 Water temperature**

The water temperature shall be not less than 28° Celsius.

**13.1.6 Lane markings**

For Diving pools that will also be used for swimming, lane markings for Diving pools shall be of a dark contrasting colour, placed on the floor of the pool in the centre of each lane.

<b>Width:</b>	minimum 0.2 metre, maximum 0.3 metre.
<b>Length:</b>	21.0 metres for 25 metre long pools.

Each lane line shall end 2.0 metres from the end wall of the pool with a distinctive cross line 1.0 metre long and of the same width as the lane line.

Target line shall be placed on the end of the walls or on the touch panels, in the centre of each lane, of the same width as the lane lines. A cross line 0.5 metre long shall be placed 0.3 metre below the water surface, measured to the centre point of the cross line. They shall extend without interruption from the deck edge (curb) to the floor or to a maximum of 3 metres.

**13.1.7 Placement and seating of diving judges**

**13.1.7.1 Individual diving**

**13.1.7.1.1** The judges will be placed side by side in a straight line on both sides of the diving pool by the Referee. The execution judges shall be in a straight line parallel to the pool; the synchronised judges shall be in a straight line perpendicular to the pool. See Appendix 1-A for diagram.

**13.1.7.1.2** When seven (7) judges are officiating, four (4) will be on the side of the pool closest to where the springboard or platform event is being contested. When five (5) judges are officiating, (3) will be on the side of the pool closest to where the springboard or platform event is being contested.

*Note: The Referee may decide to place the majority of judges (i.e. four (4) / three (3) as outlined above) on the side of the pool farthest from the springboard or platform event being contested if reasonable to do so for logistical or situational purposes.*

**13.1.7.1.3** No judge shall be seated inside or behind the direct line of the front edge of the springboards or platforms.

**13.1.7.1.4** The chairs used by judges will be numbered clockwise in consecutive order when facing the springboards / platforms.

**13.1.7.1.5** In 1 metre springboard competitions, chairs suitable for use placed directly on poolside shall be used.

**13.1.7.1.6** In 3 metre springboard competitions, the judges shall be seated at a height of not lower than two (2) metres above the water level.

**13.1.7.1.7** In the 10m platform competitions, the chairs from the 3 meter springboard competitions can be used but if at all possible, the judges shall be seated at an even higher level.

**13.1.7.1.8** To assist the judges in the 3 metre springboard and platform competitions, the judges chairs must be positioned as far back from the edge of the pool as is practical.

**13.1.7.1.9** The above recommendations are shown in the Annex of Part Four, Article 15.3 (Appendix 3).

**13.1.7.2 Synchronised diving and mixed synchronized diving**



- 13.1.7.2.1** The judges will be placed side by side in a straight line on both sides of the diving pool by Referee. The execution judges shall be in a straight line parallel to the pool; the synchronised judges shall be in a straight line perpendicular to the pool. See Appendix 1-A for diagram.
- 13.1.7.2.2** Three (3) or two (2) execution judges will be placed on both sides of the diving pool by the Referee.
- 13.1.7.2.3** The chairs used by execution judges in a synchronised event will be numbered clockwise in consecutive order when facing the springboard / platform, for example E 1, E 2 and E 3 (or E 1, E 2) on the left side and E 4, E 5 and E 6 (or E 3, E 4) on the right side.
- 13.1.7.2.4** The synchronised judges will be placed in a straight line in between the execution judges on both sides of the pool. All synchronised judges on both sides of the pool must be placed at the same horizontal distance from the springboards or platforms (not side-to-side) but will be positioned at different heights to ensure that no judge's view is obstructed
- 13.1.7.2.5** The chairs used by synchronised judges in a synchronised event will be numbered clockwise in consecutive order when facing the springboard or platform.
- 13.1.7.2.6** In synchronised competitions, the synchronised judges closest to the pool edge, shall ideally be seated at a height of not lower than 2 (two) metres above the water level.
- 13.1.7.2.7** The subsequent chair heights for the remaining synchronised judges (or additional execution judge) must increase by at least 50 cm per seat.
- 13.1.7.2.8** There shall be no interference or movement by any person in front of the judge chairs during a competition event.
- 13.1.7.2.9** The above recommendations are shown in the Annex of Part Four, Article 15.3 (Appendix 3).

**13.2 Diving Facilities for Olympic Games and World Aquatics Championships**

- 13.2.1** The pool for all events contested at the Olympic Games and World Championships should be a minimum of 5m as set out in Article 15.3, Appendix 3, All new diving facilities constructed after January 1, 2025 should have a minimum depth of 5 metres under the diving boards in accordance with the Diving Diagrams in the Appendices.

**13.2.2 Springboard Diving**

For Olympic Games and World Aquatics Championships, Part Four, Article 13.1.1 in total shall apply.

**13.2.3 Platform Diving**

For Olympic Games and World Aquatics Championships, Part Four, Article 13.1.2 in total shall apply.

**13.2.4 General Requirements**

For Olympic Games and World Aquatics Championships, Part Four, Article 13.1.3 in total shall apply.

**13.2.5 Lighting**

The light intensity at the level of 1 metre above the water surface shall not be less than 1500 lux.

**13.2.6 Water temperature**

The water temperature shall be not less than 28° Celsius.

**13.2.7 Lane markings**

Lane markings for the diving well will consist of 3 lines running the width of the diving well 90 degree angle to the diver facing forward on the springboard or platform. These lines shall be as follows:

<b>Width:</b>	minimum 0.2 metre, maximum 0.3 metres
<b>Length:</b>	21.0 metre for 25 metre wide diving well

The distance between the centre points of each lane shall be 2.5 metres.

The centre of the first line shall be directly under the plummet of the 3 metre springboard.

See Part Four, Article 15.3 (Appendix 3).

**13.2.8 Placement and seating of diving judges**



For Olympic Games and World Aquatics Championships, the Part Four, Article 13.1.7 in total shall apply.

### **13.2.9 Dry Land Facilities**

The host facility must provide a trampoline with spotting equipment. It is preferred that there be two trampolines and a dry land area with a springboard and a platform take-off into foam landing pits as detailed the appendices of Part Four, Article 15.4 (Appendix 4), Part Four, Article 15.5 (Appendix 5), Part Four, Article 15.6 (Appendix 6) and Part Four, Article 15.7 (Appendix 7).

### **13.2.10 Field of play**

Field of Play for Olympic Games and World Aquatics Championships as detailed in Part Four, Article 15.3 (Appendix 3).

If the swimming pool and diving well are in the same area, the minimum distance separating the pools shall be of 8 metres, however 10 metres is preferred (see Part Two, Article 16.2.17).

## **13.3 Electronic Officiating Equipment for Diving**

### **13.3.1 General description**

Electronic Officiating equipment records the judges awards for each diver and determines the final score for each dive as required by Part Four, Article 7.

### **13.3.2 Preferred Equipment must be able to:**

**13.3.2.1** Record judges awards by whole and half points.

**13.3.2.2** Be able to display all recorded and calculated information for each diver both before and after each dive.

**13.3.2.3** Be able to display the scores for all divers before and after each dive.

**13.3.2.4** Be able to display the rank order and scores for all divers after each round of dives.

**13.3.2.5** The equipment must provide each judge with an electronic judging device that will permit each judge to enter their award and to see their award on a window on the device. After the referee has accepted the judges awards, all awards shall be displayed on each electronic judging device.

**13.3.2.6** Judges analysis is to be provided at the conclusion of each event or series.

**13.3.2.7** The referee must be provided with a monitor on which they will be able to view the awards of all the judges prior to the awards then being displayed on the score board.

**13.3.2.8** There is a requirement for a print out of the following information;

The draw for the diving order

A start list for each session or event

A ranking of dives at the end of each round

A ranking of dives at the end of each event

Judges awards and scores for each diver at the end of each session and event

## **13.4 Dry Land Facilities**

### **13.4.1 General Requirements**

Dimensions in metres for Dry Land Facilities as detailed in Part Four, Article 15.4 (Appendix 4), Part Four, Article 15.5 (Appendix 5), Part Four, Article 15.6 (Appendix 6) and Part Four, Article 15.7 (Appendix 7).

**13.4.2** For the safety, practise and development of divers and competitions, it is strongly recommended that the guidelines presented below be incorporated into the facility and placed adjacent to the competitive diving area /facilities.

**13.4.3** When minimum dimensions are used in B and C a vertical mat or other protective surface should be attached to the appropriate forward and side walls.

## **14 MEDICAL AND SAFETY SPECIFIC REQUIREMENT FOR DIVING**



The Medical Requirements are described in the section Part One, Article 9.2. However, each sport has unique components.

**14.1 Location of the FoP First Aid Treatment Area**

When possible, the Field of Play (FoP) First Aid Treatment Area should be positioned where athletes exit.

**14.2 Water Rescue and Lifeguards**

The lifeguards at the competitions shall be experienced in deep water rescue and in the management of suspected cervical spine injury. It may happen that the diver hits the board/the platform, or land horizontally, causing a wide of severe injuries that requires a special technique to protect the cervical spine. Three (3) lifeguards are required.

**14.2.1 During Trainings**

The three (3) lifeguards shall be located on the different sides of the pool to cover a maximum of the training area.

Diagram A – Example of lifeguards location

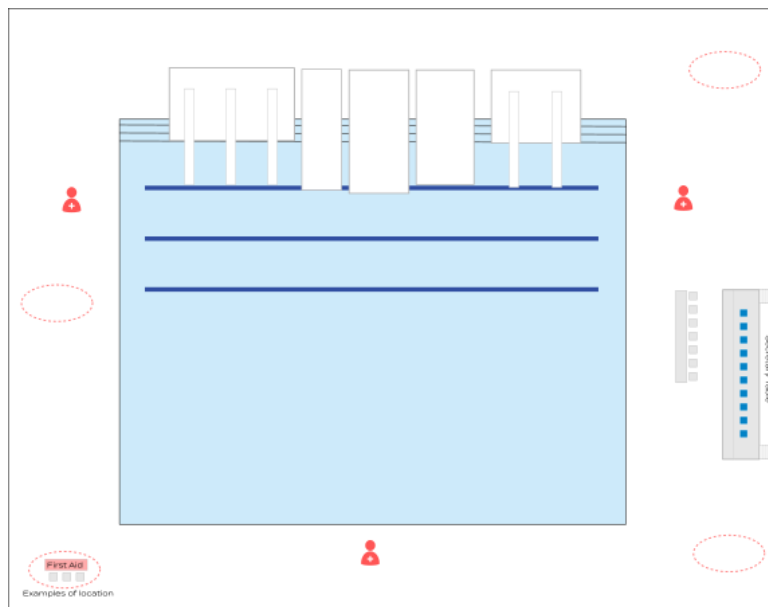

**14.2.2 During Competition**

During the Competition, two (2) lifeguards must be positioned on the side of the Event (e.g on the side of the 3m springboard). The third lifeguard shall be located on the other side of the pool.



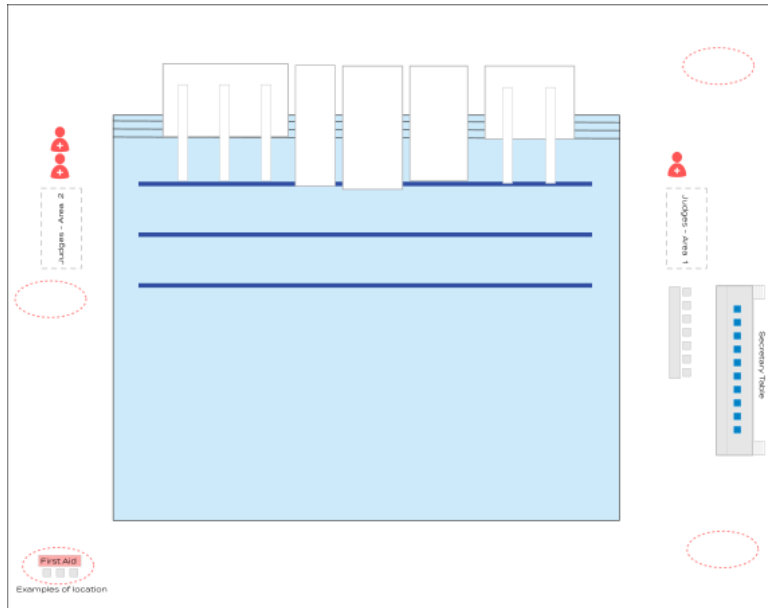

**14.2.3 Dry Land**

A first-aid responder shall be present in the dry land area and be connected to the FOP Medical Response Team.

**15 APPENDICES**

- 15.1 APPENDIX 1 - Diagram Diving Facilities
- 15.2 APPENDIX 2 - Table Diving Facilities
- 15.3 APPENDIX 3 - Diagram Diving Field of Play for Olympic Games and World Championships
- 15.4 APPENDIX 4 - Diagram Diving Dry Land Facilities
- 15.5 APPENDIX 5 - Diagram Diving Dry Land Facilities Details
- 15.6 APPENDIX 6 - Table Diving Dry land Facilities
- 15.7 APPENDIX 7 - Equipment in Dry Land Facilities
- 15.8 APPENDIX 8 - Springboard
- 15.9 APPENDIX 9 - Springboard
- 15.10 APPENDIX 10 - Platform
- 15.11 APPENDIX 11 - Platform



15.1 APPENDIX 1 - Diagram Diving Facilities

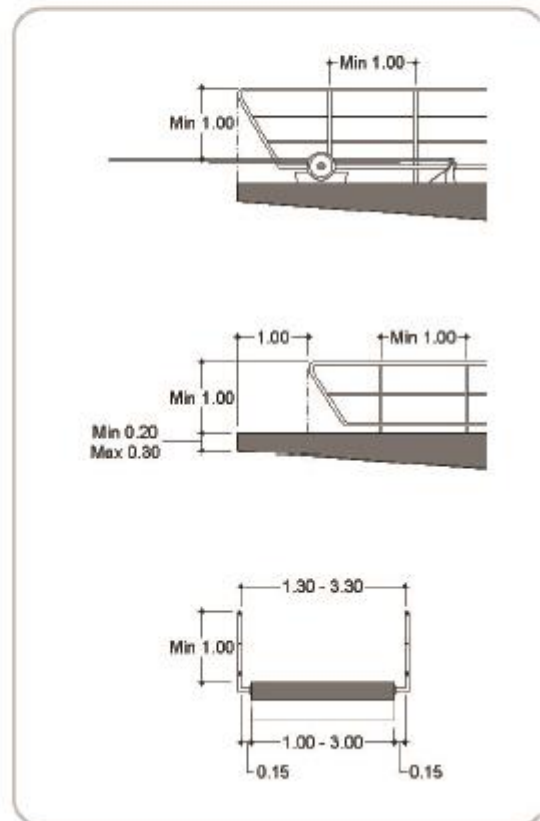
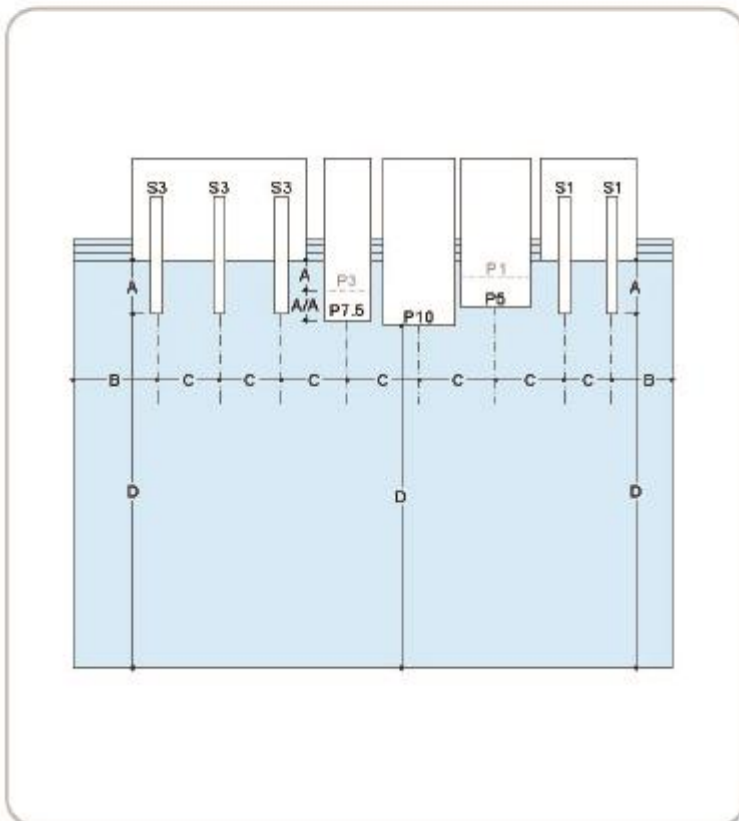
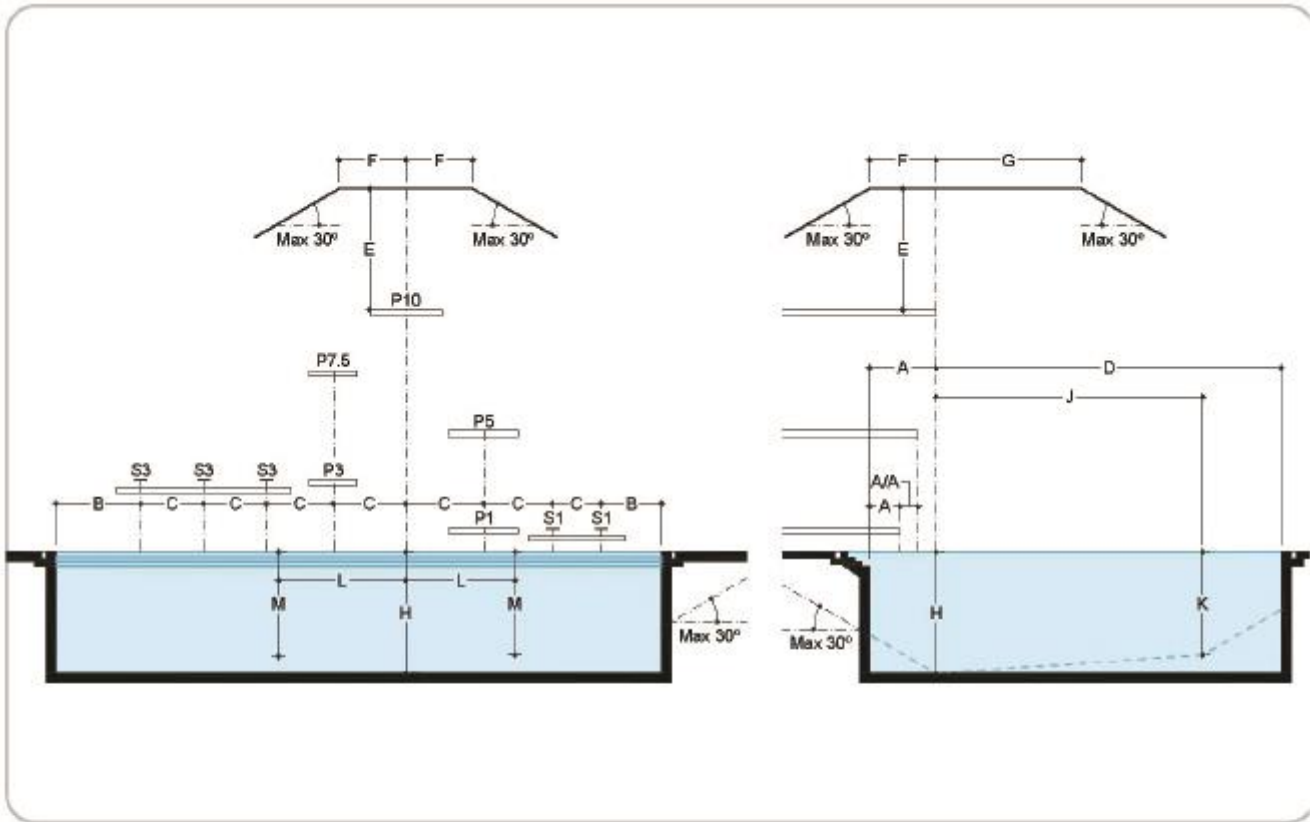



15.2 APPENDIX 2 - Table Diving Facilities

Dimensions for Diving Facilities		SPRINGBOARD				PLATFORM											
		1 metre		3 metres		1 metre		3 metres		5 metres		7.5 metres		10 metres			
	Length	4.88		4.88		5.00		5.00		6.00		6.00		6.00			
	Width	0.50		0.50		1.00 min. 2.90 pref.		1.00 min. 2.00 pref.		2.90		2.00		3.00			
	Height	1.00		3.00		0.60 min. 1.00 pref.		2.60 min. 3.00 pref.		5.00		7.50		10.00			
		Horiz	Vert	Horiz	Vert	Horiz	Vert	Horiz	Vert	Horiz	Vert	Horiz	Vert	Horiz	Vert		
A	From plumbet back to pool wall platform edge for <b>Concrete Platform</b>	Designation	A-1		A-3		A-1P		A-3P		A-5		A-7.5		A-10		
		Minimum	2.22		2.22		0.75		1.25		1.25		1.25		1.50		
		Preferred	2.22		2.22		0.75		1.25		1.25		1.25		1.50		
A/A	From plumbet back to pool wall for <b>Pedestals and Metal Stands</b>	Minimum	1.50		1.50												
		Preferred	1.83		1.83												
		Designation	A-1		A-3		A-1P		A-3P		A-5		A-7.5		A-10		
B	From plumbet to <b>Pool Wall at Side</b>	Designation	B-1		B-3		B-1P		B-3P		B-5		B-7.5		B-10		
		Minimum	2.50		3.50		2.50		3.00		4.00		4.50		5.75		
		Preferred	2.50		3.50		2.50		3.60		4.50		4.75		5.75		
C	From plumbet to <b>Adjacent Plumbet</b>	Designation	C1-1		C3-3, 3-1		C1-1P		C3-3P, 1P		C5-3, 5-1		C7.5-5, 3, 1		C10-7.5, 5, 3, 1		
		Minimum	2.00		2.20		1.85		2.20*		2.85*		2.75*		3.00*		
		Preferred	2.00		2.60		2.15		2.35*		2.85*		2.75*		3.00*		
D	From plumbet to <b>Minimum Pool Wall Ahead</b>	Designation	D-1		D-3		D-1P		D-3P		D-5		D-7.5		D-10		
		Minimum	9.00		10.25		8.00		9.50		10.25		11.00		13.50		
		Preferred	9.00		10.25		8.00		9.50		10.25		11.00		13.50		
E	On plumbet from <b>Board to Ceiling</b>	Designation	E-1		E-3		E-1P		E-3P		E-5		E-7.5		E-10		
		Minimum	5.00		5.00		3.25		3.25		3.25		3.25		4.00		
		Preferred	5.00		5.00		3.50		3.50		3.50		3.50		5.00		
F	<b>Clear Overhead</b> behind and each side of plumbet	Designation	F-1	E-1	F-3	E-3	F-1P	E-1P	F-3P	E-3P	F-5	E-5	F-7.5	E-7.5	F-10	E-10	
		Minimum	2.50	5.00	2.50	5.00	2.75	3.25	2.75	3.25	2.75	3.25	2.75	3.25	2.75	3.25	4.00
		Preferred	2.50	5.00	2.50	5.00	2.75	3.50	2.75	3.50	2.75	3.50	2.75	3.50	2.75	3.50	5.00
G	<b>Clear Overhead</b> ahead of plumbet	Designation	G-1	E-1	G-3	E-3	G-1P	E-1P	G-3P	E-3P	G-5	E-5	G-7.5	E-7.5	G-10	E-10	
		Minimum	5.00	5.00	5.00	5.00	5.00	3.25	5.00	3.25	5.00	3.25	5.00	3.25	5.00	4.00	
		Preferred	5.00	5.00	5.00	5.00	5.00	3.50	5.00	3.50	5.00	3.50	5.00	3.50	5.00	5.00	
H	<b>Depth of Water</b> at plumbet	Designation	H-1		H-3		H-1P		H-3P		H-5		H-7.5		H-10		
		Minimum	3.50		3.80		3.30		3.60		3.80		4.30		5.00		
		Preferred	5.00		5.00		5.00		5.00		5.00		5.00		5.00		
J K	<b>Distance and Depth</b> ahead of plumbet for all stands	Designation	J-1	K-1	J-3	K-3	J-1P	K-1P	J-3P	K-3P	J-5	K-5	J-7.5	K-7.5	J-10	K-10	
		Minimum	5.00	3.30	6.00	3.60	4.50	3.10	5.50	3.40	6.00	3.60	8.00	4.00	11.00	4.25	
		Preferred	5.00	3.40	6.00	3.70	4.50	3.20	5.50	3.50	6.00	3.70	8.00	4.40	11.00	4.75	
L M	<b>Distance and Depth</b> each side of plumbet	Designation	L-1	M-1	L-3	M-3	L-1P	M-1P	L-3P	M-3P	L-5	M-5	L-7.5	M-7.5	L-10	M-10	
		Minimum	1.50	3.40	2.00	3.70	1.40	3.20	1.80	3.50	3.00	3.70	3.75	4.40	4.50	5.00	
		Preferred	2.00	3.50	2.50	4.10	1.90	4.00	2.30	4.10	3.50	4.00	4.50	4.70	5.25	5.25	
N	Maximum slope to reduce dimensions beyond full requirements for pool depth and ceiling height = 30 Degrees																

Notes:

- The minimum distance between adjacent platforms must be at least 0.25 metres.
- Dimensions B (plumbet to pool wall at side) and C (plumbet to adjacent plumbet) apply to Platforms with widths as detailed in V 13.1.2.2. If Platform widths are increased, then B and C shall be increased by half the additional width(s).
- The 10 metre Platform must project 0.25 metres beyond any adjacent platform.
- All platforms must project 0.75 metres beyond any platform directly below.
- The leading edge of the concrete platforms for springboards must be at least constructed to be directly above the pool wall or beyond.
- V 13.1.3.6. The end of 5, 3 and 1m platforms must not project beyond the ends of the 3m and 1m springboards when they are adjacent to each other.



**15.3 APPENDIX 3 - Diagram Diving Field of Play for Olympic Games and World Championships**

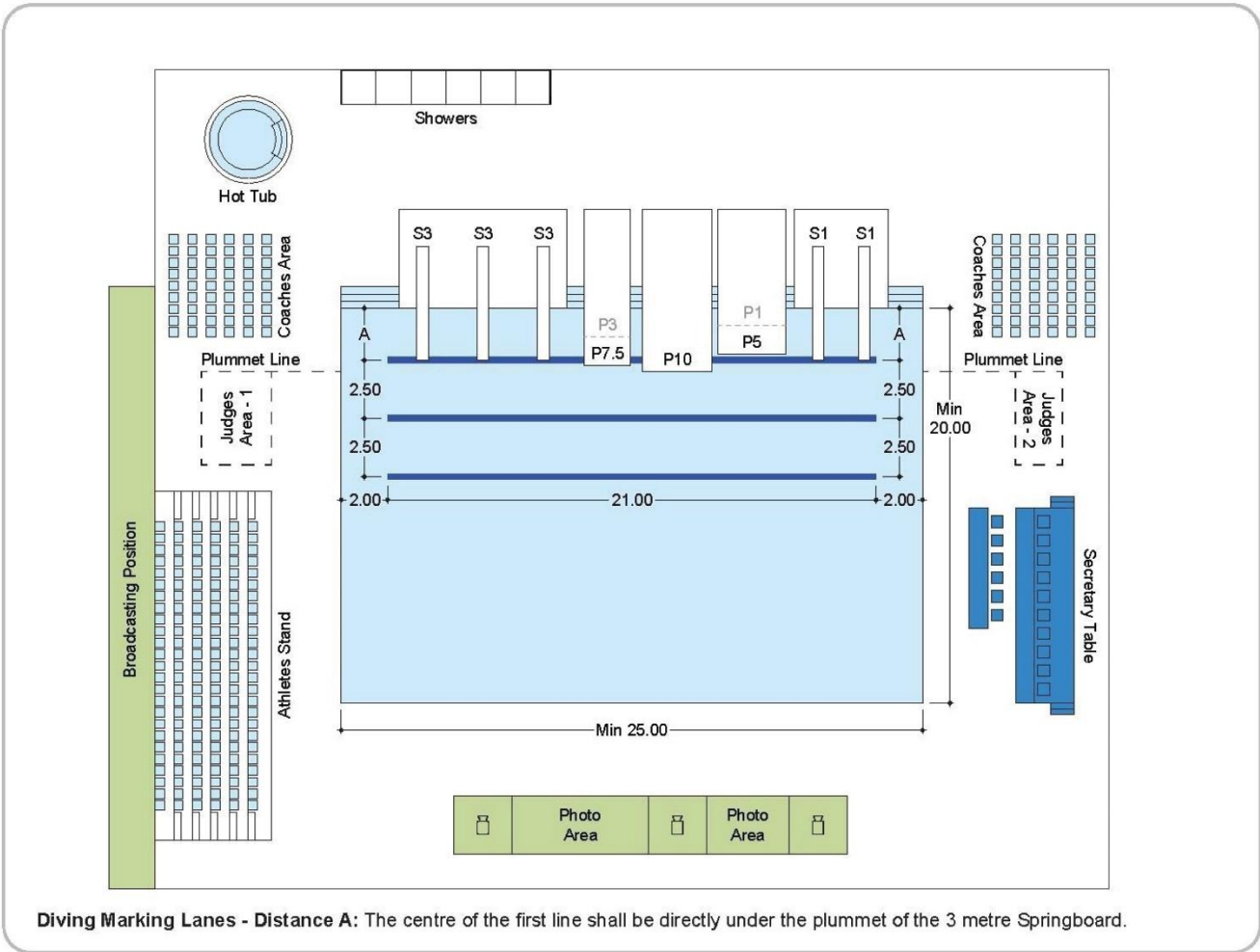

**Diving Marking Lanes - Distance A:** The centre of the first line shall be directly under the plummet of the 3 metre Springboard.

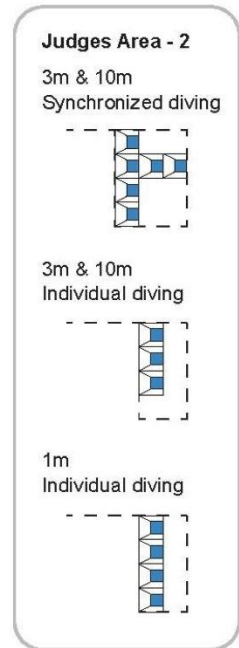
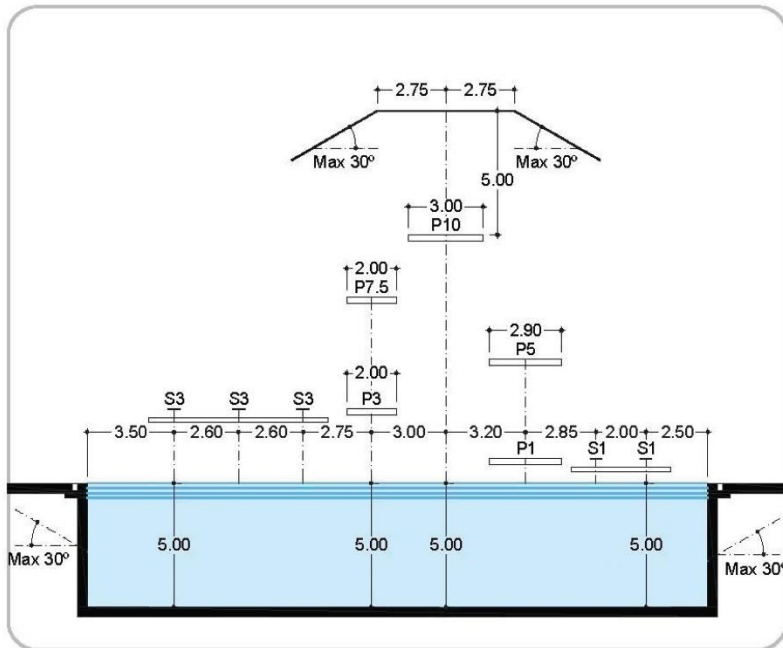
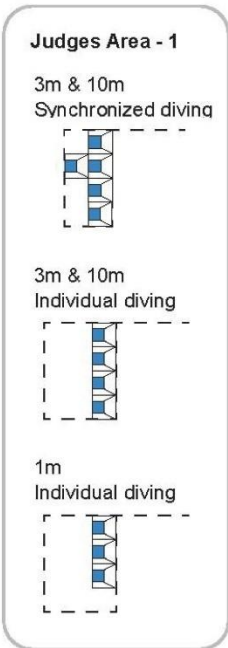



15.4 APPENDIX 4 - Diagram Diving Dry Land Facilities

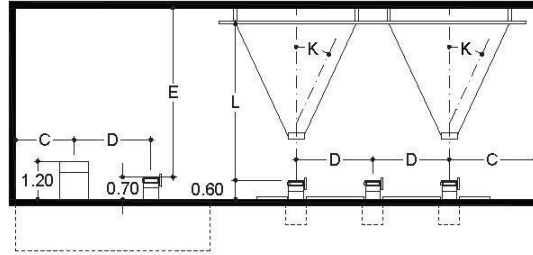

Cross Section - C1

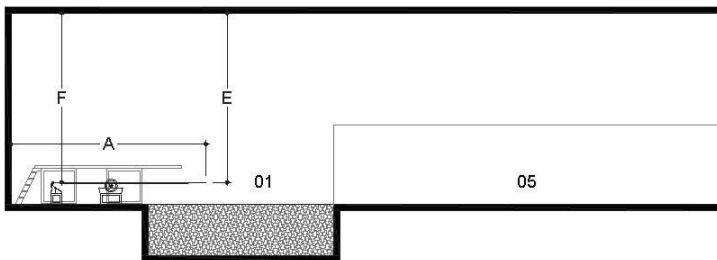

Longitudinal Section - L1

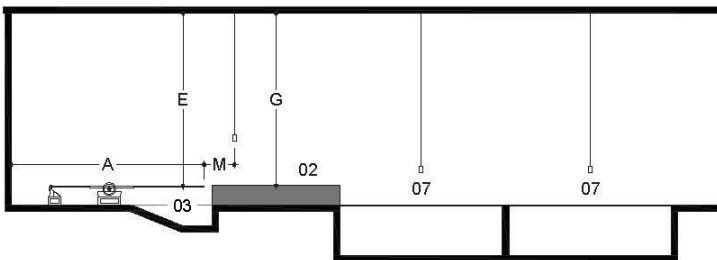

Longitudinal Section - L2

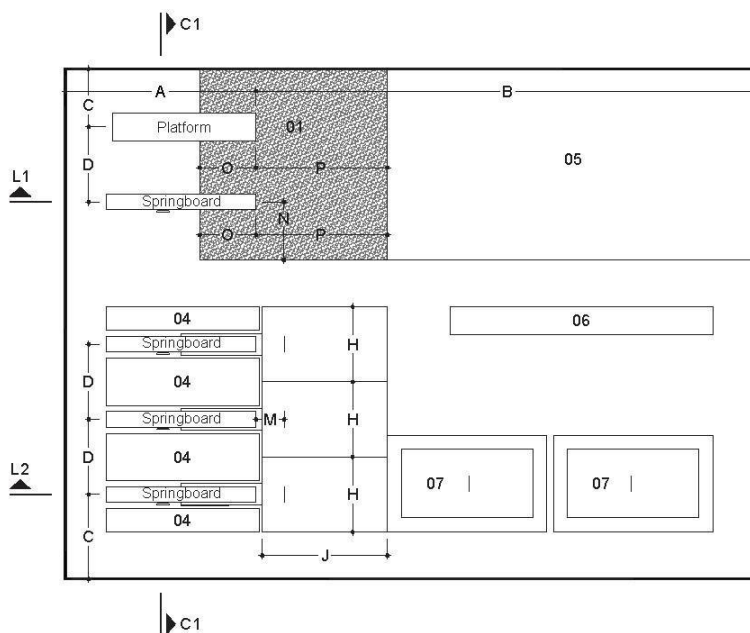

**Diving Dry Land Equipment**

1. Block Foam Land Pit
2. Landing Foam Pit
3. Pit\*
4. Mat
5. Gymnastics Spring Floor
6. Padded Platform Bench
7. Trampoline Bed

\*Minimum Pit Depth= 0.60m  
(Depends on Springboard Supplier)



15.5 APPENDIX 5 - Diagram Diving Dry Land Facilities Details

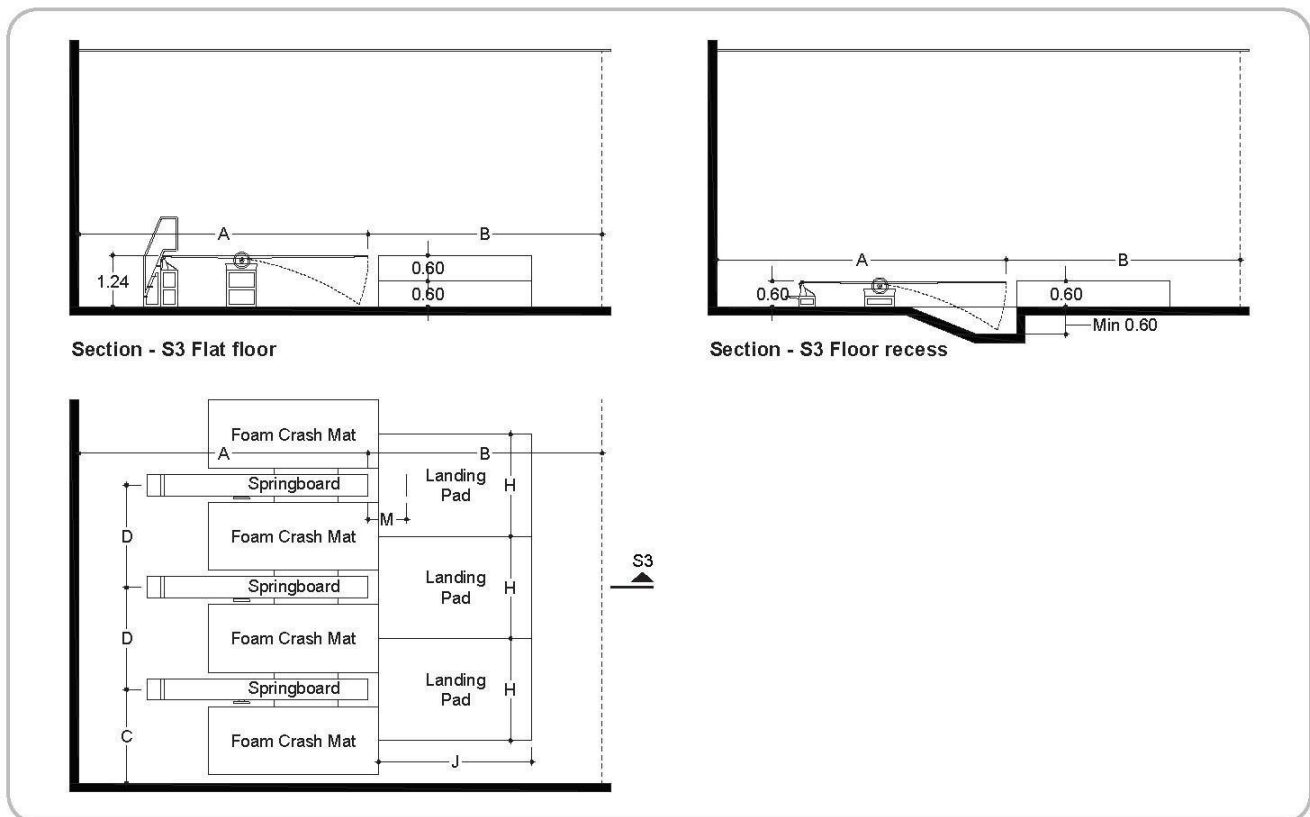
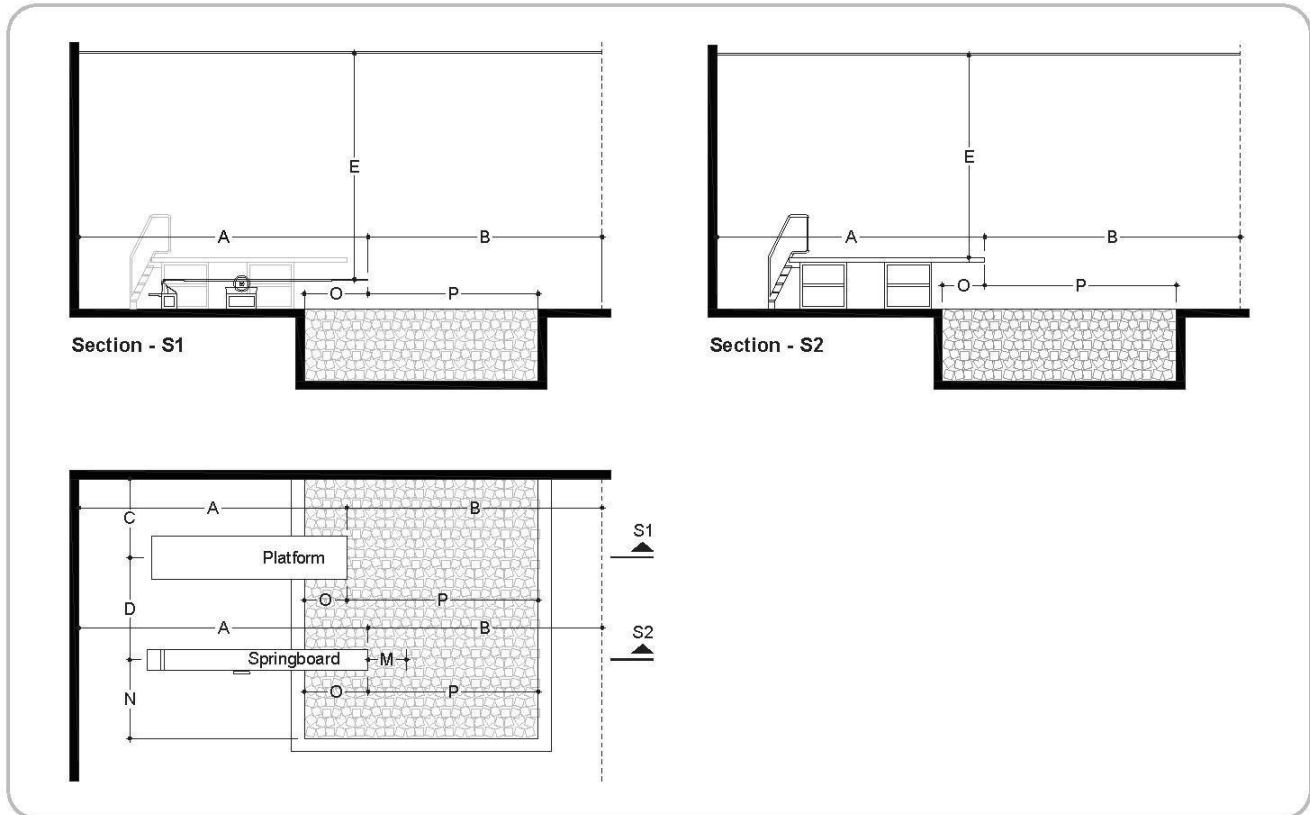

**15.6 APPENDIX 6 - Table Diving Dry land Facilities**

Diving Dry Land Facilities Design Guidelines		Springboard		Platform		
		Length	4.88	Varies		
		Width	0.50	Varies		
		Height	1.24	Varies		
		Horizontal	Vertical	Horizontal	Vertical	
A	From plumbet Back to Building Wall	Designation	A-1		A-PL	
		Minimum	4.88		Varies	
		Preferred	6.10		Infinity	
B	From plumbet to Building Wall at Ahead	Designation	B-1		B-PL	
		Minimum	3.66		3.66	
		Preferred	Infinity		Infinity	
C	From plumbet to Building Wall at Side	Designation	C-1		C-PL	
		Minimum	1.83		1.83	
		Preferred	Infinity		Infinity	
D	From plumbet to Adjacent Plumbet	Designation	D-1		D-PL	
		Minimum	2.00		2.00	
		Preferred	2.40		2.40	
E	On plumbet from Board to Ceiling	Designation		E-1		E-PL
		Minimum		5.00		2.70
		Preferred		6.40		6.40
F	Clear Overhead behind and each side of plumbet	Designation	F-1	F-1	F-PL	F-PL
		Minimum	2.50	4.50	1.50	2.70
		Preferred	Varies	6.40	Varies	6.40
G	Clear Overhead ahead of plumbet	Designation	G-1	G-1	G-PL	G-PL
		Minimum	5.00	4.50	1.50	2.70
		Preferred	Varies	6.40	Varies	6.40
H	Width or Landing Pit in front of plumbet	Designation	H-1		H-PL	
		Minimum	1.83		1.50	
		Preferred	Varies		Varies	
J	Length or Landing Pit in front of plumbet	Designation	J-1		J-PL	
		Minimum	3.66		1.50	
		Preferred	Varies		Varies	
K	Angle or Spotting Rig Ropes	Designation		K-1		K-PL
		Minimum		30°		30°
		Preferred		30° ±		30° ±
L	Height or Spotting Rig above diving board or platform	Designation		L-1		L-PL
		Minimum		4.50		4.50
		Preferred		6.40		6.40
M	Distance in front of Plumbet to Spotting Rig	Designation	M-1		M-PL	
		Minimum	0.76		0.76	
		Preferred	0.91		0.91	
N	From plumbet to Pit Wall at Side	Designation	N-1		N-PL	
		Minimum	1.83		1.83	
		Preferred	Infinity		Infinity	
O	Overhanging	Designation	O-1		O-PL	
		Minimum	1.50		1.00	
		Preferred	1.50		1.00	
P	From Plumbet to Pit Wall at Ahead	Designation	P-1		P-PL	
		Minimum	4.00		3.66	
		Preferred	Infinity		Infinity	

**Use and installation guidelines for dry land facilities with in ground and above ground trampolines.**

Installation and use instructions for trampolines and related equipment, such as frame pads, mats, end decks, and spotting systems, shall be provided by the manufacturer and shall specify the minimum safe area dimensions required for each trampoline type and relating their products to centre or edge of the trampoline.

**Clearance (trampolines):** users should refer to the manufacturer's specifications for all clearance, which may vary depending upon the manufacturer, the size of the trampoline, the type of bed in place, the type of spotting system in place, if any, and other variables. In any event, adequate space should be provided so that intended users and equipment will not come into contact with any obstacles during their anticipated use of the equipment. \*i.e., bottoming out a trampoline or dry land diving board.

**Clearance (platforms):** these specifications apply to facilities used by AQUA level international athletes. Other specifications may be appropriate for junior or development programs, so long as adequate space is provided so that intended users and equipment will not come into contact with any obstacle during their anticipated use of the equipment.

**Caution:** The specifications within this page should be carefully considered in relation to the design of the dryland training site, and all safety aspects should be thoroughly evaluated.



**15.7 APPENDIX 7 - Equipment in Dry Land Facilities**

Recommended Equipment in Dry Land Facility							
For a major event: Minimum of 350-400 square meters will be needed for the equipment. If necessary, the space can be divided in to separate areas. For example, using an existing gymnasium and a separate area for dry boards, pits and other diving related equipment.							
World Aquatics minimum requirement for new and existing dryland facilities are minimum of 275 square meters.							
			Number		Suggested dimensions		
1	<b>Diving Boards</b>	Springboard as FR 5.1.1 mounted on diving stands with movable fulcrums.	Minimum	2			
			Preferred	4			
2	<b>Dry Land Stands</b>		Minimum	2			
			Preferred	4			
3	<b>Diving Board Landing mats</b>	Foam landing mats for Dry land diving boards are located in front of the diving boards	Minimum	2	Floor	Width	Length
			Preferred	4	120cm	1.50m min.	1.50m min.
4	<b>Trampolines</b>		Minimum	2			
			Preferred	4			
5	<b>Spotting rigs</b>	2 rigs over 2 of the 4 trampolines		2			
6	<b>Panel mats</b>		Minimum	8			
			Preferred	8			
7	<b>Stall bars</b>	Stall bars minimum use 4 people					
8	<b>Foam Crash Mats</b>		Minimum	2	Height	Width	Length
			Preferred	4	22cm	2m	3m
9	<b>Somersault Boxes</b>		Minimum	8	Height	Width	Length
			Preferred	8	0.3m	1m	1m
10	<b>Landing mats for somersault boxes</b>		Minimum	8			
			Preferred	8			
11	<b>Platform in to foam pit</b>			1	1-3m		
12	<b>Spring floor or air track one mat</b>				0.2m min.	1m min.	10m min.
13	<b>Stretching Mats</b>		Minimum	2	Height	Width	Length
			Preferred	4	0.3m	1m	2m
14	<b>Large Mirrors</b>	Should be placed on walls so divers can observe body movements while training on equipment.					
15	<b>Video Replay System (Similar to TIVO)</b>	With at least 2 cameras and 2 monitors. This allows divers to review acrobatic skills performed on springboard and trampoline.					
16	<b>Weight Lifting Equipment</b>	Combination of free weights and weight lifting machines.					
17	<b>Cardio Conditioning Equipment</b>	stationary bicycles.	Minimum	2			
			Preferred	4			
*Please note: Foam crash mats may be stacked to a height of 120cm for the foam landing pads, or Foam pits maybe used instead of landing pads.							

**15.8 APPENDIX 8 - Springboard**
**World Aquatics Degree of difficulty – Formula and components**

Note: Degree of Difficulty (DD) is calculated by adding:

$$A + B + C + D + E = DD$$

**A. Somersaults**

Level / Somersault(s)	0	½	1	1½	2	2½	3	3½	4	4½
1m	0.9	1.1	1.2	1.6	2.0	2.4	2.7	3.0	3.3	3.8
3m	1.0	1.3	1.3	1.5	1.8	2.2	2.3	2.8	2.9	3.5

**B. Flight Position For flying dives add fly position (E) to either (B) or (C) Position**

	0 - 1 Somersault				1½ - 2 Somersaults				2½ Somersaults				3 - 3½ Somersaults				4 - 4½ Somersaults			
	Fwd	Back	Rev	Inw	Fwd	Back	Rev	Inw	Fwd	Back	Rev	Inw	Fwd	Back	Rev	Inw	Fwd	Back	Rev	Inw
<b>C = Tuck</b>	0.1	0.1	0.1	-0.3	0	0	0	0.1	0	0.1	0	0.2	0	0	0	0.3	0	0.1	0.2	0.4
<b>B = Pike</b>	0.2	0.2	0.2	-0.2	0.1	0.3	0.3	0.3	0.2	0.3	0.2	0.5	0.3	0.3	0.3	0.6	0.4	0.4	0.5	0.8
<b>A = Str</b>	0.3	0.3	0.3	0.1	0.4	0.5	0.6	0.8	0.6	0.7	0.6	-	-	-	-	-	-	-	-	-
<b>D = Free</b>	0.1	0.1	0.1	-0.1	0	-0.1	-0.1	0.2	0	-0.1	-0.2	0.4	0	0	0	-	-	-	-	-
<b>E = Fly</b>	0.2	0.1	0.1	0.4	0.2	0.2	0.2	0.5	0.3	0.3	0.3	0.7	0.4	-	-	-	-	-	-	-

Seven of the above components have negative values. Dashes indicate dives that currently are not possible.

**C. Twists**

Group	½ Twist ½ - 1 Som.	½ Twist 1½ - 2 Som.	½ Twist 2½ Som.	½ Twist 3 - 3½ Som.	1 Twist	1½ Twists ½ - 2 Som.	1½ Twists 2½-3½ Som.	2 Twists	2½ Twist ½ - 2 Som.	2½ Twists 2½-3½ Som.	3 Twists	3½ Twists	4 Twists	4½ Twists
<b>Fwd.</b>	0.4	0.4	0.4	0.4	0.6	0.8	0.8	1.0	1.2	1.2	1.5	1.6	1.9	2.0
<b>Back</b>	0.2	0.4	0	0	0.4	0.8	0.7	0.8	1.2	1.1	1.4	1.7	1.8	2.1
<b>Rev.</b>	0.2	0.4	0	0	0.4	0.8	0.6	0.8	1.2	1.0	1.4	1.8	1.8	2.1
<b>Inw.</b>	0.2	0.4	0.2	0.4	0.4	0.8	0.8	0.8	1.2	1.2	1.5	1.6	1.9	2.0

Dives with ½ somersault and twists can only be executed in positions A, B, or C,

Dives with 1 or 1½ somersaults and twists can only be executed in position D,

Dives with 2 or more somersaults and twists can only be executed in positions B or C

**D. Approach**

Level	Forward ½ - 3½ Som.	Forward 4 - 4½ Som.	Back ½ - 3 Som.	Back 3½ - 4½ Som.	Reverse ½ - 3 Som.	Reverse 3½ - 4½ Som.	Inward ½ - 1 Som.	Inward 1½ - 4½ Som.
1m	0	0.5	0.2	0.6	0.3	0.5	0.6	0.5
3m	0	0.3	0.2	0.4	0.3	0.3	0.3	0.3

**E. Unnatural Entry (does not apply to twisting dives)**



Group	½ Som.	1 Som.	1½ Som.	2 Som.	2½ Som.	3 Som.	3½ Som.	4 Som.	4½ Som.
<b>Forward / Inward</b>	-	0.1	-	0.2	-	0.2	-	0.2	-
<b>Back / Re-verse</b>	0.1	-	0.2	-	0.3	-	0.4	-	0.4

A value indicates the diver does not see the water before the entry. The component is the same at all levels. (-) indicates the diver does see the water before the entry. The component is the same at all levels.

**Examples**

Dive	Pos	Height	A	B	C	D	E	DD
<b>207</b>	B	3	2.8	0.3	0.0	0.4	0.4	<b>3.9</b>
<b>207</b>	C	3	2.8	0.0	0.0	0.4	0.4	<b>3.6</b>
<b>5253</b>	B	3	2.2	0.3	0.7	0.2	0	<b>3.4</b>
<b>5355</b>	B	3	2.2	0.2	1.0	0.2	0	<b>3.7</b>

Dive	Pos	Height	A	B	C	D	E	DD
<b>309</b>	B	3	3.5	0.5	0.0	0.3	0.4	<b>4.7</b>
<b>309</b>	C	3	3.5	0.2	0.0	0.3	0.4	<b>4.4</b>
<b>5255</b>	B	3	2.2	0.3	1.1	0.2	0	<b>3.8</b>
<b>313</b>	C	3	1.5	0.2	0	0.3	0.2	<b>2.2</b>

**15.9 APPENDIX 9 - Springboard**
**World Aquatics Table of Degree of difficulty**

In the following table, a dive with (-) is not possible and dives with empty spaces have not been calculated.

SPRINGBOARD		1 METER				3 METER			
		STR	PIKE	TUCK	FREE	STR	PIKE	TUCK	FREE
Forward Group		A	B	C	D	A	B	C	D
101	Forward Dive	1.4	1.3	1.2	-	1.6	1.5	1.4	-
102	Forward Somersault	1.6	1.5	1.4	-	1.7	1.6	1.5	-
103	Forward 1½ Somersaults	2.0	1.7	1.6	-	1.9	1.6	1.5	-
104	Forward 2 Somersaults	2.6	2.3	2.2	-	2.4	2.1	2.0	-
105	Forward 2½ Somersaults		2.6	2.4	-	2.8	2.4	2.2	-
106	Forward 3 Somersaults		3.2	2.9	-		2.8	2.5	-
107	Forward 3½ Somersaults		3.3	3.0	-		3.1	2.8	-
108	Forward 4 Somersaults			4.0	-		3.8	3.4	-
109	Forward 4½ Somersaults			4.3	-		4.2	3.8	-
112	Forward Flying Somersault	-	1.7	1.6	-	-	1.8	1.7	-
113	Forward Flying 1½ Somersaults	-	1.9	1.8	-	-	1.8	1.7	-
115	Forward Flying 2½ Somersaults	-			-	-	2.7	2.5	-

Back Group		A	B	C	D	A	B	C	D
201	Back Dive	1.7	1.6	1.5	-	1.9	1.8	1.7	-
202	Back Somersault	1.7	1.6	1.5	-	1.8	1.7	1.6	-
203	Back 1½ Somersaults	2.5	2.3	2.0	-	2.4	2.2	1.9	-
204	Back 2 Somersaults		2.5	2.2	-	2.5	2.3	2.0	-
205	Back 2½ Somersaults		3.2	3.0	-		3.0	2.8	-
206	Back 3 Somersaults		3.2	2.9	-		2.8	2.5	-
207	Back 3½ Somersaults				-		3.9	3.6	-
208	Back 4 Somersaults				-		3.7	3.4	-
209	Back 4½ Somersaults				-		4.7	4.4	-
212	Back Flying Somersault	-	1.7	1.6	-	-	1.8	1.7	-
213	Back Flying 1½ Somersaults	-			-	-	2.4	2.1	-
215	Back Flying 2½ Somersaults	-			-	-	3.3	3.1	-

Reverse Group		A	B	C	D	A	B	C	D
301	Reverse Dive	1.8	1.7	1.6	-	2.0	1.9	1.8	-
302	Reverse Somersault	1.8	1.7	1.6	-	1.9	1.8	1.7	-
303	Reverse 1½ Somersaults	2.7	2.4	2.1	-	2.6	2.3	2.0	-
304	Reverse 2 Somersaults	2.9	2.6	2.3	-	2.7	2.4	2.1	-
305	Reverse 2½ Somersaults		3.2	3.0	-	3.4	3.0	2.8	-
306	Reverse 3 Somersaults		3.3	3.0	-		2.9	2.6	-
307	Reverse 3½ Somersaults				-		3.8	3.5	-
308	Reverse 4 Somersaults				-		3.7	3.4	-
309	Reverse 4½ Somersaults				-		4.7	4.4	-
312	Reverse Flying Somersault	-	1.8	1.7	-	-	1.9	1.8	-
313	Reverse Flying 1½ Somersaults	-	2.6	2.3	-	-	2.5	2.2	-



SPRINGBOARD		1 METER				3 METER			
		STR	PIKE	TUCK	FREE	STR	PIKE	TUCK	FREE
Inward Group		A	B	C	D	A	B	C	D
401	Inward Dive	1.8	1.5	1.4	-	1.7	1.4	1.3	-
402	Inward Somersault	2.0	1.7	1.6	-	1.8	1.5	1.4	-
403	Inward 1½ Somersaults		2.4	2.2	-		2.1	1.9	-
404	Inward 2 Somersaults		3.0	2.8	-		2.6	2.4	-
405	Inward 2½ Somersaults		3.4	3.1	-		3.0	2.7	-
407	Inward 3½ Somersaults				-		3.7	3.4	-
409	Inward 4½ Somersaults				-		4.6	4.2	--
412	Inward Flying Somersault	-	2.1	2.0	-	-	1.9	1.8	-
413	Inward Flying 1½ Somersaults	-	2.9	2.7	-	-	2.6	2.4	-

Twisting Group (Forward)		A	B	C	D	A	B	C	D
5111	Forward Dive ½ Twist	1.8	1.7	1.6	-	2.0	1.9	1.8	-
5112	Forward Dive 1 Twist	2.0	1.9		-	2.2	2.1		-
5121	Forward Somersault ½ Twist	-	-	-	1.7	-	-	-	1.8
5122	Forward Somersault 1 Twist	-	-	-	1.9	-	-	-	2.0
5124	Forward Somersault 2 Twists	-	-	-	2.3	-	-	-	2.4
5126	Forward Somersault 3 Twists	-	-	-	2.8	-	-	-	2.9
5131	Forward 1½ Somersaults ½ Twist	-	-	-	2.0	-	-	-	1.9
5132	Forward 1½ Somersaults 1 Twist	-	-	-	2.2	-	-	-	2.1
5134	Forward 1½ Somersaults 2 Twists	-	-	-	2.6	-	-	-	2.5
5136	Forward 1½ Somersaults 3 Twists	-	-	-	3.1	-	-	-	3.0
5138	Forward 1½ Somersaults 4 Twists	-	-	-	3.5	-	-	-	3.4
5151	Forward 2½ Somersaults ½ Twist	-	3.0	2.8	-	-	2.8	2.6	-
5152	Forward 2½ Somersaults 1 Twist	-	3.2	3.0	-	-	3.0	2.8	-
5154	Forward 2½ Somersaults 2 Twists	-	3.6	3.4	-	-	3.4	3.2	-
5156	Forward 2½ Somersaults 3 Twists	-			-	-	3.9	3.7	-
5172	Forward 3½ Somersaults 1 Twist	-			-	-	3.7	3.4	-

Twisting Group (Back)		A	B	C	D	A	B	C	D
5211	Back Dive ½ Twist	1.8	1.7	1.6	-	2.0	1.9	1.8	-
5212	Back Dive 1 Twist	2.0			-	2.2			-
5221	Back Somersault ½ Twist	-	-	-	1.7	-	-	-	1.8
5222	Back Somersault 1 Twist	-	-	-	1.9	-	-	-	2.0
5223	Back Somersault 1½ Twists	-	-	-	2.3	-	-	-	2.4
5225	Back Somersault 2½ Twists	-	-	-	2.7	-	-	-	2.8
5227	Back Somersault 3½ Twists	-	-	-	3.2	-	-	-	3.3
5231	Back 1½ Somersaults ½ Twist	-	-	-	2.1	-	-	-	2.0
5233	Back 1½ Somersaults 1½ Twists	-	-	-	2.5	-	-	-	2.4
5235	Back 1½ Somersaults 2½ Twists	-	-	-	2.9	-	-	-	2.8
5237	Back 1½ Somersaults 3½ Twists	-	-	-	-	-	-	-	3.3
5239	Back 1½ Somersaults 4½ Twists	-	-	-	-	-	-	-	3.7
5251	Back 2½ Somersaults ½ Twist	-	2.9	2.7	-	-	2.7	2.5	-
5253	Back 2½ Somersaults 1½ Twists	-			-	-	3.4	3.2	-
5255	Back 2½ Somersaults 2½ Twists	-			-	-	3.8	3.6	-



SPRINGBOARD		1 METER				3 METER			
		STR	PIKE	TUCK	FREE	STR	PIKE	TUCK	FREE
Twisting Group (Reverse)		A	B	C	D	A	B	C	D
5311	Reverse Dive ½ Twist	1.9	1.8	1.7	-	2.1	2.0	1.9	-
5312	Reverse Dive 1 Twist	2.1			-	2.3			-
5321	Reverse Somersault ½ Twist	-	-	-	1.8	-	-	-	1.9
5322	Reverse Somersault 1 Twist	-	-	-	2.0	-	-	-	2.1
5323	Reverse Somersault 1½ Twists	-	-	-	2.4	-	-	-	2.5
5325	Reverse Somersault 2½ Twists	-	-	-	2.8	-	-	-	2.9
5331	Reverse 1½ Somersaults ½ Twist	-	-	-	2.2	-	-	-	2.1
5333	Reverse 1½ Somersaults 1½ Twists	-	-	-	2.6	-	-	-	2.5
5335	Reverse 1½ Somersaults 2½ Twists	-	-	-	3.0	-	-	-	2.9
5337	Reverse 1½ Somersaults 3½ Twists	-	-	-	3.6	-	-	-	3.5
5339	Reverse 1½ Somersaults 4½ Twists	-	-	-	-	-	-	-	3.8
5351	Reverse 2½ Somersaults ½ Twist	-	2.9	2.7	-	-	2.7	2.5	-
5353	Reverse 2½ Somersaults 1½ Twists	-	3.5	3.3	-	-	3.3	3.1	-
5355	Reverse 2½ Somersaults 2½ Twists	-	3.9	3.7	-	-	3.7	3.5	-
5371	Reverse 3½ Somersaults ½ Twist	-			-	-	3.4	3.1	-
5373	Reverse 3½ Somersaults 1½ Twists	-			-	-		3.7	-
5375	Reverse 3½ Somersaults 2 ½ Twists	-			-	-		4.1	-

Twisting Group (Inward)		A	B	C	D	A	B	C	D
5411	Inward Dive ½ Twist	2.0	1.7	1.6	-	1.9	1.6	1.5	-
5412	Inward Dive 1 Twist	2.2	1.9	1.8	-	2.1	1.8	1.7	-
5421	Inward Somersault ½ Twist	-	-	-	1.9	-	-	-	1.7
5422	Inward Somersault 1 Twist	-	-	-	2.1	-	-	-	1.9
5432	Inward 1½ Somersaults 1 Twist	-	-	-	2.7	-	-	-	2.4
5434	Inward 1½ Somersaults 2 Twists	-	-	-	3.1	-	-	-	2.8
5436	Inward 1½ Somersaults 3 Twists	-	-	-		-	-	-	3.5

**15.10 APPENDIX 10 - Platform**
**World Aquatics Degree of difficulty – Formula and components**

Note: Degree of Difficulty (DD) is calculated by adding:

$$A + B + C + D + E = DD$$

**A. Somersaults**

Level	Somersault(s)										
	0	½	1	1½	2	2½	3	3½	4	4½	5½
5 m	0.9	1.1	1.2	1.6	2.0	2.4	2.7	3.0	-	-	-
7½ m	1.0	1.3	1.3	1.5	1.8	2.2	2.3	2.8	3.5	3.5	-
10 m	1.0	1.3	1.4	1.5	1.9	2.1	2.5	2.7	3.5	3.5	4.5

**B. Flight Position For flying dives add fly position (E) to either (B) or (C) Position**

	0 - 1 Somersault					1½ - 2 Somersaults					2½ Somersaults				
	Fwd	Back	Rev	Inw	Arm	Fwd	Back	Rev	Inw	Arm	Fwd	Back	Rev	Inw	Arm
<b>C = Tuck</b>	0.1	0.1	0.1	-0.3	0.1	0	0	0	0.1	0	0	0.1	0	0.2	0.1
<b>B = Pike</b>	0.2	0.2	0.2	-0.2	0.3	0.1	0.3	0.3	0.3	0.3	0.2	0.3	0.2	0.5	0
<b>A = Str</b>	0.3	0.3	0.3	0.1	0.4	0.4	0.5	0.6	0.8	0.5	0.6	0.7	0.6	-	-
<b>D = Free</b>	0.1	0.1	0.1	-0.1	0	0	-0.1	-0.1	0.2	0	0	-0.1	-0.2	0.4	0
<b>E = Fly</b>	0.2	0.1	0.1	0.4	-	0.2	0.2	0.2	0.5	-	0.3	0.3	0.3	0.7	-

	3 - 3½ Somersaults					4 - 4½ Somersaults					5½ Som
	Fwd	Back	Rev	Inw	Arm	Fwd	Back	Rev	Inw	Arm	Fwd
<b>C = Tuck</b>	0	0	0	0.3	0.2	0	0.1	0.3	0.4	0.3	0
<b>B = Pike</b>	0.3	0.3	0.3	0.6	0.4	0.4	0.4	0.6	0.7	0.5	-
<b>A = Str</b>	-	-	-	-	-	-	-	-	-	-	-
<b>D = Free</b>	0	0	0	-	-	-	-	-	-	-	-
<b>E = Fly</b>	0.4	-	-	-	-	-	-	-	-	-	-

Seven of the above components have negative values. Dashes indicate dives that currently are not possible.

**C. Twists**

Group	½ Twist ½ - 1 Som.	½ Twist 1½ - 2 Som.	½ Twist 2½ Som.	½ Twist 3 - 3½ Som.	1 Twist	1½ Twists ½ - 2 Som.	1½ Twists 2½ - 3½ Som.	2 Twists	2½ Twists ½ - 2 Som.	2½ Twists 2½ - 3½ Som.	3 Twists	3½ Twists ½ - 2 Som.	3½ Twists 2½ - 3½ Som.	4 Twists	4½ Twists ½ - 2 Som.	4½ Twists 2½ - 3½ Som.
<b>Forward</b>	0.4	0.4	0.4	0.4	0.6	0.8	0.8	1.0	1.2	1.2	1.5	1.6	1.6	1.9	2.0	2.0
<b>Back</b>	0.2	0.4	0	0	0.4	0.8	0.6	0.8	1.2	1.0	1.4	1.7	1.5	1.8	2.1	1.9
<b>Reverse</b>	0.2	0.4	0	0	0.4	0.8	0.6	0.8	1.2	1.0	1.4	1.7	1.5	1.8	2.1	1.9
<b>Inward</b>	0.2	0.4	0.2	0.4	0.4	0.8	0.8	0.8	1.2	1.2	1.5	1.6	1.6	1.9	2.0	2.0
<b>Arm. Forw.</b>	0.4	0.5	0.5	0.4	1.2	1.3	1.3	1.5	1.7	1.7	1.9	2.1	2.1	2.3	2.5	2.5
<b>Arm. Back / Rev</b>	0.4	0.5	0.5	0.5	1.2	1.3	1.3	1.3	1.7	1.7	1.9	2.1	2.1	2.3	2.5	2.5

Dives with ½ somersault and twists can only be executed in positions A, B, or C,

Dives with 1 or 1½ somersaults and twists can only be executed in position D,

Dives with 2 or more somersaults and twists can only be executed in positions B or C,

Armstand dives with 1, 1½, or 2 somersaults and one or more twists can only be executed in position D, and

Armstand dives with 2½ or more somersaults and twist can only be executed in positions B or C

**D. Approach Forward-, Back-, Reverse-, Inward-, and Twisting Groups**

Level	Forward ½ - 3½ Soms.	Forward 4 - 5½ Soms.	Back ½ - 3 Soms.	Back 3½ - 4½ Soms.	Reverse ½ - 2 Soms.	Reverse 2½ - 3 Soms.	Reverse 3½ - 4½ Soms.	Inward ½ - 1 Soms.	Inward 1½ - 4½ Soms.
<b>5 m</b>	0	0.5	0.2	0.5	0.3	0.4	0.6	0.6	0.5
<b>7.5 m</b>	0	0.3	0.2	0.3	0.3	0.4	0.4	0.3	0.3
<b>10 m</b>	0	0.2	0.2	0.2	0.3	0.4	0.3	0.3	0.2

**E. Approach Armstand Group** (Does not apply to armstand dives with twists).

Level	Armstand Forward With 0 - 2 Soms.	Armstand Forward with more than 2 Soms	Armstand Back with 0 - ½ Soms.	Armstand Back With 1 - 4 Soms.	Armstand Reverse With 0 - ½ Som.	Armstand Reverse With 1 - 4 Soms.	Armstand Inward with 0-2 Soms.	Armstand Inward with more than 2 Soms.
<b>5m/7.5m/10m</b>	0.2	0.4	0.2	0.4	0.3	0.5	0.3	0.5



**F. Unnatural Entry (does not apply to twisting dives)**

Group	½ Som.	1 Som.	1½ Som.	2 Som.	2½ Som.	3 Som.	3½ Som.	4 Som.	4½ Som.	5½ Som.
<b>Forward / Inward</b>	-	0.1	-	0.2	-	0.2	-	0.0	-	-
<b>Back / Reverse</b>	0.1	-	0.2	-	0.3	-	0.4	-	0.4	0.0
<b>Armstand Back / Reverse</b>	-	0.1	-	0.2	-	0.2	-	0.3	-	-
<b>Armstand Forward/Inward</b>	0.1	-	0.2	-	0.3	-	0.4	-	0.4	0.0

A value indicates the diver does not see the water before the entry. The component is the same at all levels.  
 (-) indicates the diver does see the water before the entry. The component is the same at all levels.

**Examples**

Dive	Pos	Height	A	B	C	D	E	DD
307	B	10	2.7	0.3	0.0	0.3	0.4	3.7
307	C	10	2.7	0.0	0.0	0.3	0.4	3.4
5371	B	10	2.7	0.3	0.0	0.3	0.0	3.3
5371	B	10	2.1	0.3	1.5	0.2	0.0	4.1

Dive	Pos	Height	A	B	C	D	E	DD
309	B	10	3.5	0.6	0.0	0.3	0.4	4.8
309	C	10	3.5	0.3	0.0	0.3	0.4	4.5
5371	C	10	2.7	0.0	0.0	0.3	0.0	3.0
6247	D	10	1.9	0.0	2.1	0.0	0.0	4.0

**15.11 APPENDIX 11 - Platform**
**World Aquatics Table of Degree of Difficulty**

In the following table, a dive with (-) is not possible and dives with empty spaces have not been calculated.

PLATFORM		10 METER				7.5 METER				5 METER			
		STR	PIKE	TUCK	FREE	STR	PIKE	TUCK	FREE	STR	PIKE	TUCK	FREE
<b>Forward Group</b>		<b>A</b>	<b>B</b>	<b>C</b>	<b>D</b>	<b>A</b>	<b>B</b>	<b>C</b>	<b>D</b>	<b>A</b>	<b>B</b>	<b>C</b>	<b>D</b>
101	Forward Dive	1.6	1.5	1.4	-	1.6	1.5	1.4	-	1.4	1.3	1.2	-
102	Forward 1 Somersault	1.8	1.7	1.6	-	1.7	1.6	1.5	-	1.6	1.5	1.4	-
103	Forward 1½ Somersaults	1.9	1.6	1.5	-	1.9	1.6	1.5	-	2.0	1.7	1.6	-
104	Forward 2 Somersaults	2.5	2.2	2.1	-	2.4	2.1	2.0	-	2.6	2.3	2.2	-
105	Forward 2½ Somersaults	2.7	2.3	2.1	-		2.4	2.2	-		2.6	2.4	-
106	Forward 3 Somersaults		3.0	2.7	-		2.8	2.5	-		3.2	2.9	-
107	Forward 3½ Somersaults		3.0	2.7	-		3.1	2.8	-			3.0	-
108	Forward 4 Somersaults		4.1	3.7	-				-				-
109	Forward 4½ Somersaults		4.1	3.7	-				-				-
1011	Forward 5½ Somersaults			4.7	-				-				-
112	Forward Flying Somersaults	-	1.9	1.8	-	-	1.8	1.7	-	-	1.7	1.6	-
113	Forward Flying 1½ Somersaults	-	1.8	1.7	-	-	1.8	1.7	-	-	1.9	1.8	-
114	Forward Flying 2 Somersaults	-	2.4	2.3	-	-	2.3	2.2	-	-	2.5	2.4	-
115	Forward Flying 2½ Somersaults	-	2.6	2.4	-	-		2.5	-	-			-

<b>Back Group</b>		<b>A</b>	<b>B</b>	<b>C</b>	<b>D</b>	<b>A</b>	<b>B</b>	<b>C</b>	<b>D</b>	<b>A</b>	<b>B</b>	<b>C</b>	<b>D</b>
201	Back Dive	1.9	1.8	1.7	-	1.9	1.8	1.7	-	1.7	1.6	1.5	-
202	Back 1 Somersault	1.9	1.8	1.7	-	1.8	1.7	1.6	-	1.7	1.6	1.5	-
203	Back 1½ Somersaults	2.4	2.2	1.9	-	2.4	2.2	1.9	-	2.5	2.3	2.0	-
204	Back 2 Soms Somersaults	2.6	2.4	2.1	-	2.5	2.3	2.0	-		2.5	2.2	-
205	Back 2½ Somersaults	3.3	2.9	2.7	-		3.0	2.8	-		3.2	3.0	-
206	Back 3 Somersaults		3.0	2.7	-		2.8	2.5	-		3.2	2.9	-
207	Back 3½ Somersaults		3.6	3.3	-			3.5	-				-
208	Back 4 Somersaults		4.1	3.8	-		4.2	3.9	-		4.4	4.1	-
209	Back 4½ Somersaults		4.5	4.2	-				-				-
212	Back Flying Somersaults	-	1.9	1.8	-	-	1.8	1.7	-	-	1.7	1.6	-
213	Back Flying 1½ Somersaults	-	2.4	2.1	-	-	2.4	2.1	-	-	2.5	2.2	-
215	Back Flying 2½ Somersaults	-	3.2	3.0	-	-			-	-			-



PLATFORM		10 METER				7.5 METER				5 METER			
		STR	PIKE	TUCK	FREE	STR	PIKE	TUCK	FREE	STR	PIKE	TUCK	FREE
<b>Reverse Group</b>		<b>A</b>	<b>B</b>	<b>C</b>	<b>D</b>	<b>A</b>	<b>B</b>	<b>C</b>	<b>D</b>	<b>A</b>	<b>B</b>	<b>C</b>	<b>D</b>
301	Reverse Dive	2.0	1.9	1.8	-	2.0	1.9	1.8	-	1.8	1.7	1.6	-
302	Reverse 1 Somersault	2.0	1.9	1.8	-	1.9	1.8	1.7	-	1.8	1.7	1.6	-
303	Reverse 1½ Somersaults	2.6	2.3	2.0	-	2.6	2.3	2.0	-	2.7	2.4	2.1	-
304	Reverse 2 Somersaults	2.8	2.5	2.2	-	2.7	2.4	2.1	-	2.9	2.6	2.3	-
305	Reverse 2½ Somersaults	3.4	3.0	2.8	-	3.5	3.1	2.9	-		3.3	3.1	-
306	Reverse 3 Somersaults		3.2	2.9	-		3.0	2.7	-		3.4	3.1	-
307	Reverse 3½ Somersaults		3.7	3.4	-				-				-
308	Reverse 4 Somersaults		4.4	4.1	-		4.5	4.2	-				-
309	Reverse 4½ Somersaults		4.8	4.5	-				-				-
312	Reverse Flying Somersaults	-	2.0	1.9	-	-	1.9	1.8	-	-	1.8	1.7	-
313	Reverse Flying 1½ Somersaults	-	2.5	2.2	-	-	2.5	2.2	-	-	2.6	2.3	-

<b>Inward Group</b>		<b>A</b>	<b>B</b>	<b>C</b>	<b>D</b>	<b>A</b>	<b>B</b>	<b>C</b>	<b>D</b>	<b>A</b>	<b>B</b>	<b>C</b>	<b>D</b>
401	Inward Dive	1.7	1.4	1.3	-	1.7	1.4	1.3	-	1.8	1.5	1.4	-
402	Inward 1 Somersault	1.9	1.6	1.5	-	1.8	1.5	1.4	-	2.0	1.7	1.6	-
403	Inward 1½ Somersault		2.0	1.8	-		2.1	1.9	-		2.4	2.2	-
404	Inward 2 Somersaults		2.6	2.4	-		2.6	2.4	-		3.0	2.8	-
405	Inward 2½ Somersaults		2.8	2.5	-		3.0	2.7	-		3.4	3.1	-
406	Inward 3 Somersaults		3.5	3.2	-		3.4	3.1	-		4.0	3.7	-
407	Inward 3½ Somersaults		3.5	3.2	-			3.4	-				-
408	Inward 4 Somersaults		4.4	4.1	-				-				-
409	Inward 4½ Somersaults		4.4	4.1	-				-				-
412	Inward Flying Somersaults	-	2.0	1.9	-	-	1.9	1.8	-	-	2.1	2.0	-
413	Inward Flying 1½ Somersaults	-	2.5	2.3	-	-	2.6	2.4	-	-	2.9	2.7	-

<b>Twisting Group (Forward)</b>		<b>A</b>	<b>B</b>	<b>C</b>	<b>D</b>	<b>A</b>	<b>B</b>	<b>C</b>	<b>D</b>	<b>A</b>	<b>B</b>	<b>C</b>	<b>D</b>
5111	Fwd Dive ½ Twist	2.0	1.9	1.8	-	2.0	1.9	1.8	-	1.8	1.7	1.6	-
5112	Fwd Dive 1 Twist	2.2	2.1		-	2.2	2.1		-	2.0	1.9		-
5121	Fwd Somersault ½ Twist	-	-	-	1.9	-	-	-	1.8	-	-	-	1.7
5122	Fwd Somersault 1 Twist	-	-	-	2.1	-	-	-	2.0	-	-	-	1.9
5124	Fwd Somersault 2 Twists	-	-	-	2.5	-	-	-	2.4	-	-	-	2.3
5131	Fwd 1½ Somersaults ½ Twist	-	-	-	1.9	-	-	-	1.9	-	-	-	2.0
5132	Fwd 1½ Somersaults 1 Twist	-	-	-	2.1	-	-	-	2.1	-	-	-	2.2
5134	Fwd 1½ Somersaults 2 Twists	-	-	-	2.5	-	-	-	2.5	-	-	-	2.6
5136	Fwd 1½ Somersaults 3 Twists	-	-	-	3.0	-	-	-	3.0	-	-	-	3.1
5138	Fwd 1½ Somersaults 4 Twists	-	-	-	3.4	-	-	-	3.4	-	-	-	3.5
5152	Fwd 2½ Somersaults 1 Twist	-	2.9	2.7	-	-	3.0	2.8	-	-	3.2	3.0	-
5154	Fwd 2½ Somersaults 2 Twists	-	3.3	3.1	-	-	3.4	3.2	-	-	3.6	3.4	-
5156	Fwd 2½ Somersaults 3 Twists	-	3.8	3.6	-	-			-	-			-
5172	Fwd 3½ Somersaults 1 Twist	-	3.6	3.3	-	-	3.7	3.4	-	-	-	-	-



PLATFORM		10 METER				7.5 METER				5 METER			
		STR	PIKE	TUCK	FREE	STR	PIKE	TUCK	FREE	STR	PIKE	TUCK	FREE
<b>Twisting Group (Back)</b>		<b>A</b>	<b>B</b>	<b>C</b>	<b>D</b>	<b>A</b>	<b>B</b>	<b>C</b>	<b>D</b>	<b>A</b>	<b>B</b>	<b>C</b>	<b>D</b>
5211	Back Dive ½ Twist	2.0	1.9	1.8	-	2.0	1.9	1.8	-	1.8	1.7	1.6	-
5212	Back Dive 1 Twist	2.2			-	2.2			-	2.0			-
5221	Back Somersault ½ Twist	-	-	-	1.9	-	-	-	1.8	-	-	-	1.7
5222	Back Somersault 1 Twist	-	-	-	2.1	-	-	-	2.0	-	-	-	1.9
5223	Back Somersault 1½ Twists	-	-	-	2.5	-	-	-	2.4	-	-	-	2.3
5225	Back Somersault 2½ Twists	-	-	-	2.9	-	-	-	2.8	-	-	-	2.7
5231	Back 1½ Somersaults ½ Twist	-	-	-	2.0	-	--	-	2.0	-	-	-	2.1
5233	Back 1½ Somersaults 1½ Twists	-	-	-	2.4	-	-	-	2.4	-	-	-	2.5
5235	Back 1½ Somersaults 2½ Twists	-	-	-	2.8	-	-	-	2.8	-	-	-	2.9
5237	Back 1½ Somersaults 3½ Twists	-	-	-	3.3	-	-	-	3.3	-	-	-	3.4
5239	Back 1½ Somersaults 4½ Twists	-	-	-	3.7	-	-	-	3.7	-	-	-	3.8
5251	Back 2½ Somersaults ½ Twist	-	2.6	2.4	-	-	2.7	2.5	-	-	2.9	2.7	-
5253	Back 2½ Somersaults 1½ Twists	-	3.2	3.0	-	-	3.3	3.1	-	-			-
5255	Back 2½ Somersaults 2½ Twists	-	3.6	3.4	-	-			-	-			-
5257	Back 2½ Somersaults 3½ Twists	-	4.1	3.9	-	-			-	-			-
5271	Back 3½ Somersaults ½ Twist	-	3.2	2.9	-	-			-	-			-
5273	Back 3½ Somersaults 1½ Twist	-	3.8	3.5	-	-			-	-			-
5275	Back 3½ Somersaults 2½ Twist	-	4.2	3.9	-	-			-	-			-

<b>Twisting Group (Reverse)</b>		<b>A</b>	<b>B</b>	<b>C</b>	<b>D</b>	<b>A</b>	<b>B</b>	<b>C</b>	<b>D</b>	<b>A</b>	<b>B</b>	<b>C</b>	<b>D</b>
5311	Reverse Dive ½ Twist	2.1	2.0	1.9	-	2.1	2.0	1.9	-	1.9	1.8	1.7	-
5312	Reverse Dive 1 Twist	2.3			-	2.3			-	2.1			-
5321	Reverse Somersault ½ Twist	-	-	-	2.0	-	-	-	1.9	-	-	-	1.8
5322	Reverse Somersault 1 Twist	-	-	-	2.2	-	-	-	2.1	-	-	-	2.0
5323	Reverse Somersault 1½ Twists	-	-	-	2.6	-	-	-	2.5	-	-	-	2.4
5325	Reverse Somersault 2½ Twists	-	-	-	3.0	-	-	-	2.9	-	-	-	2.8
5331	Reverse 1½ Soms. ½ Twists	-	-	-	2.1	-	-	-	2.1	-	-	-	2.2
5333	Reverse 1½ Soms. 1½ Twists	-	-	-	2.5	-	-	-	2.5	-	-	-	2.6
5335	Reverse 1½ Soms. 2½ Twists	-	-	-	2.9	-	-	-	2.9	-	-	-	3.0
5337	Reverse 1½ Soms. 3½ Twists	-	-	-	3.4	-	-	-	3.4	-	-	-	3.5
5339	Reverse 1½ Soms. 4½ Twists	-	-	-	3.8	-	-	-	3.8	-	-	-	-
5351	Reverse 2½ Soms. ½ Twists	-	2.7	2.5	-	-	2.8	2.6	-	-	3.0	2.8	-
5353	Reverse 2½ Soms. 1½ Twists	-	3.3	3.1	-	-	3.4	3.2	-	-		3.4	-
5355	Reverse 2½ Soms. 2½ Twists	-	3.7	3.5	-	-	3.8	3.6	-	-		3.8	-
5371	Reverse 3½ Soms. ½ Twists	-	3.3	3.0	-	-			-	-			-
5373	Reverse 3½ Soms. 1½ Twist	-		3.6	-	-			-	-			-
5375	Reverse 3½ Soms. 2½ Twist	-		4.0	-	-			-	-			-



PLATFORM		10 METER				7.5 METER				5 METER			
		STR	PIKE	TUCK	FREE	STR	PIKE	TUCK	FREE	STR	PIKE	TUCK	FREE
<b>Twisting Group (Inward)</b>		<b>A</b>	<b>B</b>	<b>C</b>	<b>D</b>	<b>A</b>	<b>B</b>	<b>C</b>	<b>D</b>	<b>A</b>	<b>B</b>	<b>C</b>	<b>D</b>
5411	Inward Dive ½ Twist	1.9	1.6	1.5	-	1.9	1.6	1.5	-	2.0	1.7	1.6	-
5412	Inward Dive 1 Twist	2.1	1.8	1.7	-	2.1	1.8	1.7	-	2.2	1.9	1.8	-
5421	Inward Somersault ½ Twist	-	-	-	1.8	-	-	-	1.7	-	-	-	1.9
5422	Inward Somersault 1 Twist	-	-	-	2.0	-	-	-	1.9	-	-	-	2.1
5432	Inward 1½ Somersaults 1 Twist	-	-	-	2.3	-	-	-	2.4	-	-	-	2.7
5434	Inward 1½ Somersaults 2 Twists	-	-	-	2.7	-	-	-	2.8	-	-	-	3.1
5436	Inward 1½ Somersaults 3 Twists	-	-	-	3.4	-	-	-	-	-	-	-	-

Armstand Group		A	B	C	D	A	B	C	D	A	B	C	D
610	Armstand Dive (armstand with body back to water)	1.6	-	-	-	1.6	-	-	-	1.5	-	-	-
611	Armstand Forward ½ Somersault	2.0	1.9	1.7	-	2.0	1.9	1.7	-	1.8	1.7	1.5	-
612	Armstand Forward 1 Somersault	2.0	1.9	1.7	-	1.9	1.8	1.6	-	1.8	1.7	1.5	-
614	Armstand Forward 2 Somersaults	-	2.4	2.1	-	-	2.3	2.0	-	-	2.5	2.2	-
616	Armstand Forward 3 Somersaults	-	3.3	3.1	-	-	-	-	-	-	-	-	-

621	Armstand Back ½ Somersault	1.9	1.8	1.6	-	1.9	1.8	1.6	-	1.7	1.6	1.4	-
622	Armstand Back Somersault	2.3	2.2	2.0	-	2.2	2.1	1.9	-	2.1	2.0	1.8	-
623	Armstand Back 1½ Somersaults	-	2.2	1.9	-	-	2.2	1.9	-	-	2.3	2.0	-
624	Armstand Back 2 Somersaults	3.0	2.8	2.5	-	2.9	2.7	2.4	-	3.1	2.9	2.6	-
626	Armstand Back 3 Somersaults	-	3.5	3.3	-	-	3.3	3.1	-	-	-	3.5	-
628	Armstand Back 4 Somersaults	-	4.7	4.5	-	-	-	-	-	-	-	-	-

631	Armstand Reverse ½ Somersault	2.0	1.9	1.7	-	2.0	1.9	1.7	-	1.8	1.7	1.5	-
632	Armstand Reverse 1 Somersault	-	2.3	2.1	-	-	2.2	2.0	-	-	2.1	1.9	-
633	Armstand Reverse 1½ Somersaults	-	2.3	2.0	-	-	2.3	2.0	-	-	2.4	2.1	-
634	Armstand Reverse 2 Somersaults	-	2.9	2.6	-	-	2.8	2.5	-	-	3.0	2.7	-
636	Armstand Reverse 3 Somersaults	-	3.6	3.4	-	-	-	3.2	-	-	-	-	-
638	Armstand Reverse 4 Somersaults	-	4.8	4.6	-	-	-	-	-	-	-	-	-

640	Armstand Dive (armstand with body front to water)	1.7	-	-	-	1.7	-	-	-	1.6	-	-	-
641	Armstand Inward 1/2 Somersault	-	2.0	1.8	-	-	2.0	1.8	-	-	1.8	1.6	-
642	Armstand Inward 1 Somersault	-	2.0	1.8	-	-	1.9	1.7	-	-	1.8	1.6	-
644	Armstand Inward 2 Somersaults	-	2.5	2.2	-	-	2.4	2.1	-	-	2.6	2.3	-
646	Armstand Inward 3 Somersaults	-	3.4	3.2	-	-	-	-	-	-	-	-	-



6122	Armstand Fwd Som. 1 Twist	-	-	-	2.6	-	-	-	2.5	-	-	-	2.4
6124	Armstand Fwd Som. 2 Twists	-	-	-	2.9	-	-	-	2.8	-	-	-	2.7
6142	Armstand Fwd 2 Soms. 1 Twist	-	-	-	3.1	-	-	-	3.0	-	-	-	3.2
6144	Armstand Fwd 2 Soms. 2 Twists	-	-	-	3.4	-	-	-	3.3	-	-	-	3.5
6162	Armstand Fwd 3 Soms. 1 Twist	-		3.9	-	-			-	-			-
6221	Armstand Back Som. ½ Twist	-	-	-	1.8	-	-	-	1.7	-	-	-	1.6
6241	Armstand Back 2 Soms. ½ Twist	-	2.7	2.4	-	-	2.6	2.3	-	-	2.8	2.5	-
6243	Armstand Back 2 Soms 1½ Twists	-	-	-	3.2	-	-	-	3.1	-	-	-	3.3
6245	Armstand Back 2 Soms 2½ Twists	-	-	-	3.6	-	-	-	3.5	-	-	-	3.7
6247	Armstand Back 2 Soms 3½ Twists	-	-	-	4.0	-	-	-		-	-	-	
6261	Armstand Back 3 Soms. ½ Twist	-	3.4	3.2	-	-	3.2	3.0	-	-	3.6	3.4	-
6263	Armstand Back 3 Soms 1½ Twists	-	4.2	4.0	-	-			-	-			-
6265	Armstand Back 3 Soms 2½ Twists	-	4.6	4.4	-	-			-	-			-



WORLD  
AQUATICS

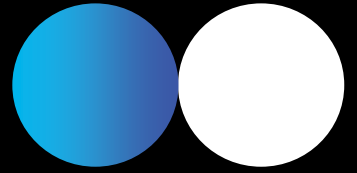

# HIGH DIVING

COMPETITION  
REGULATIONS

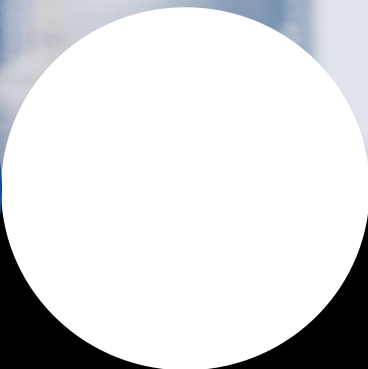
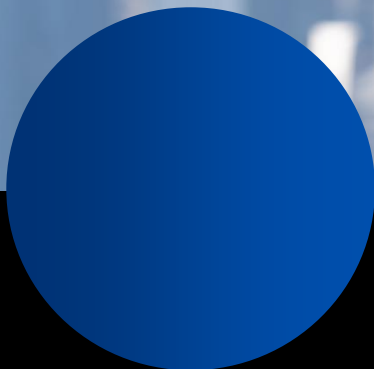



## TABLE OF CONTENTS

### PART FIVE: HIGH DIVING RULES

<b>PART FIVE: HIGH DIVING RULES</b> .....	<b>185</b>
<b>1</b> GENERAL .....	<b>185</b>
<b>2</b> COMPETITIONS .....	<b>186</b>
<b>3</b> COMPETITION FORMAT .....	<b>187</b>
<b>4</b> STATEMENT OF DIVES .....	<b>187</b>
<b>5</b> COMPETITION PROCEDURE .....	<b>188</b>
<b>6</b> DUTIES OF THE REFEREE AND ASSISTANT REFEREES .....	<b>188</b>
<b>7</b> DUTIES OF THE SECRETARIAT .....	<b>190</b>
<b>8</b> JUDGING .....	<b>191</b>
<b>9</b> SUMMARY OF THE PENALTIES .....	<b>193</b>
<b>10</b> AGE GROUP RULES .....	<b>195</b>
<b>11</b> HIGH DIVING FACILITIES AND EQUIPMENT .....	<b>196</b>
11.5.1 APPENDIX 1 - Diagram / General Standard Facilities .....	202
11.5.2 APPENDIX 2 - Table / General Standard Facilities Dimensions .....	203
11.5.3 APPENDIX 3 - Diagram / Temporary Round Pools .....	205
11.5.4 APPENDIX 4 - Table / Temporary Round Pools / Dimensions .....	206
11.5.5 APPENDIX 5 - Diagram / General Standard Facilities combined with Diving .....	207
<b>12</b> DEGREE OF DIFFICULTY - FORMULA AND TABLES .....	<b>208</b>
12.1 Degree of Difficulty - Formula and Components .....	208
12.2 Tables of Degree of Difficulties .....	212





## PART FIVE: HIGH DIVING RULES

### 1 GENERAL

**1.1** These Rules shall govern all World Aquatics High Diving competitions including World Aquatics Championships and High Diving World Cups.

**1.2** All High Diving installations shall be in accordance with the World Aquatics Facilities Rules, inspected and approved by World Aquatics Delegate, and a member of the Technical High Diving Commission no later than 120 days prior to the start of the competitions. Construction of new installations should be subject to an inspection of the proposed site and environmental conditions prior to commencement.

**1.3** Divers younger than 18 years on December 31<sup>st</sup> in the year of the competition shall not be permitted to compete at the World Aquatics Championships or World Cups.

#### 1.4 Diving Number Designations

**1.4.1** All dives shall be designated by a system of 3, 4 or 5 numerals followed by a single letter.

**1.4.2** The dives are divided into five (5) groups. The first digit (or the first two digits) shall indicate the group to which the dive belongs:

<b>Front and front twist:</b>	1 or 51
<b>Back and back twist:</b>	2 or 52
<b>Reverse and reverse twist:</b>	3 or 53
<b>Inward and inward twist:</b>	4 or 54
<b>Armstand and armstand twist:</b>	6 or 61 – 62 – 63 – 64

**1.4.3** In the Front, Back, Reverse and Inward group with three (3) numerals, a one (1) in the second digit indicates that the dive has a flying action during the dive. When there is no flying action the second digit shall be 0. The third digit shall indicate the number of half somersaults to be performed. For example: 2 = 1 somersault, 8 = 4 somersaults. When there are 5 or more somersaults there will be four digits with the third and fourth digit indicating the number of half somersaults. For example 10 = 5 somersaults as 10(10) in a forward 5 somersaults.

**1.4.4** In the Front, Back, Reverse and Inward group with four (4) numerals, a five (5) in the first digit indicates that the dive includes a twist. The second digit indicates the group or direction to which the dive belongs (for Example 5163 = front). The third digit indicates the number of half somersaults to be performed (for example 6 = 3 somersaults). The fourth digit indicates the number of half twists to be performed (for example 3 = 1 ½ twists). When there are five (5) or more twists, the last two digits indicates the number of ½ twists. For example, 524(10) in 2 somersaults back with five twists. In this case the number designation contains 5 numerals.

**1.4.5** In the Armstand group with three digits (with the first digit 6) the second digit indicates the group or direction to which the dive belongs:

61 = Front

62 = Back

63 = Reverse

64 = Inward

The third digit indicates the number of ½ somersault.

**1.4.6** In the Armstand group with four digits, the fourth digit indicates the number of half twists to be performed. When there are 5 or more twists the last two digits indicate the number of ½ twists. For example, 625(10) in Armstand back 2 ½ somersaults with 5 twists. In this case the number designation contains 5 numerals.

**1.4.7** The letter at the end of the dive number shall indicate the position in which the dive is performed:

A = Straight

B = Pike

C = Tuck



D = Free

E = 3 positions

**1.4.8** "Free" position means any combination of one or more positions and is restricted in its use in some dive with twist.

**1.4.9** 3 positions means that during the dive all positions A, B and C must be shown. The straight position (A) must be shown as second position.

**1.5 Degree of Difficulty**

**1.5.1** The degree of difficulty of each dive is calculated using the following formula (the component values of the formula are outlined in Part Five, Article 12.1):

$$\mathbf{A + B + C + D + E + F = \text{DEGREE OF DIFFICULTY (DD)}}$$

**1.5.2** As a guide, dives with their numbers and DD are tabled in Part Five, Article 12.2.

**1.5.3** Any dive which is not tabled in Part Five, Article 12.2, but is used in a competition, shall be given the dive number and DD as determined in accordance with Part Five, Articles 1.4 and 1.5.

**1.5.3.1** In calculating the degree of difficulty for dives with twists, the following needs to be noted to determine the position:

Note: Dives with somersaults and Barani only are not considered as twisting dives. Barani is considered as control position.

Somersaults	twisting dives			
1 or 2	D			
3	Forward and Inward		Back and Reverse	
	From 1 to 2 ½ twists	3 or more twists	From ½ to 3 twists	3 ½ or more twists
	B or C	D	B or C	D
4 or more	B or C			

Somersaults	Armstand twisting dives			
1 ½	D			
2 ½	Forward		Back	
	From 1 to 1 ½ twists	2 or more twists	From ½ to 1 ½ twists	2 or more twists
	B or C	D	B or C	D
3 1/2	B or C			

**1.5.4** The Part Five, *Articles* 12.1 and 12.2 of these Competition Regulations are established by the World Aquatics Technical High Diving Committee (THDC) and approved by the World Aquatics Bureau.

## 2 COMPETITIONS

### 2.1 General

**2.1.1** All entered high divers must submit evidence of safely executed dives for approval by the World Aquatics THDC in order to compete.

*Note: The THDC appoints a "Safe to dive" panel to determine a diver's ability to safely compete, to approve new dives for competition, and to exclude divers from competition based on observation during training and / or competition days.*

**2.1.2** The order of diving shall be determined by a random draw. This shall be held at a Technical Meeting immediately after the final training session and prior to the first day of competition. When available an electronic draw shall be used.



- 2.1.3** At the World Aquatics Championships and other World Aquatics events there shall be a direct final competition. The last round of dives shall be performed in the reverse order of the ranking at the end of the previous round. In the case of a tie, the dive order shall be determined by a draw between the affected divers.

*Note: The THDC may establish a special competition format for the World Aquatics Championships. The special competition format must be approved by the World Aquatics Bureau.*

- 2.1.4** To determine the result, the scores of the dives of a diver are added. When two or more divers score the same number of points, a tie shall be declared for that particular place.

- 2.1.5** In all events, the diver with the highest total points shall be declared the winner of that event. Their final points shall rank the remaining divers.

- 2.1.6** The procedure for protests is outlined in Part One, Article 13.

## **2.2 Women 20m Platform**

- 2.2.1** The height of the Women's competition shall be 20 metres. In special surroundings (i.e. natural), the height tolerance can be +/- 0.50 meter.

## **2.3 Men 27m Platform**

- 2.3.1** The height of the Men's competition shall be 27 metres. In special surroundings (i.e. natural), the height tolerance can be +/- 0.50 meter.

# **3 COMPETITION FORMAT**

- 3.1** The Men's and Women's competition is divided into two (2) sessions in a two (2) or three (3) day program as agreed between World Aquatics and the OC.

- 3.2** The competitions for men and women shall comprise four (4) dives. A dive of the same number shall be regarded as the same dive.

## **3.3 Women 20m Platform**

- 3.3.1** The Women's competitions shall comprise four (4) dives. One (1) required dive with a maximum Degree of Difficulty (DD) of 2.6 and one (1) intermediate dive with a maximum DD of 3.4 from two (2) different groups, and two (2) optional dives without limit of DD from two (2) different groups.

- 3.3.2** If the DD of the required dive is less than 2.6 or of the intermediate dive less than 3.4, the calculated DD following Part Five, Articles 1.4, 1.5 and 12.2 will be used. If a diver performs a dive above 2.6 respectively 3.4 they will only receive 2.6 respectively 3.4.

## **3.4 Men 27m Platform**

- 3.4.1** The Men's competitions shall comprise four (4) dives. One (1) required dives with a maximum DD of 2.8 and one (1) intermediate dive with a maximum DD of 3.6 from two (2) different groups, and two (2) optional dives without limit of DD from two (2) different groups.

- 3.4.2** If the DD of a required dive is less than 2.8 or of the intermediate dive less than 3.6, the calculated DD following Part Five, Articles 1.4, 1.5 and 12.2 will be used. If a diver performs a dive above 2.8 respectively 3.6 they will only receive 2.8 respectively 3.6.

# **4 STATEMENT OF DIVES**

- 4.1** Each diver shall deliver to the Referee, a complete statement of the selected dives on the official form of the event for the competition. A diver may provide two (2) reserve dives which may be substituted five (5) minutes before commencement of the final round of dives subject to the dive being compliant with the competition rules.

- 4.2** The diver is responsible for the accuracy of the statement in the list and the diver shall sign the statement of dives.

- 4.3** The statement of dives shall be submitted 24 hours before commencement of the competition.



- 4.4** The Referee may accept changes up to one hour after the end of the final published training session for each event. Changes may be made up to three (3) hours prior to the commencement of the competition, provided a fee accompanies it equivalent of two-hundred-fifty (250) Swiss Francs.
- 4.5** Unless the statement is presented within the time prescribed, a diver shall not be admitted to the competition.
- 4.6** When the closing times have passed, no change in the statement of dives shall be permitted.
- 4.7** The statement of dives shall contain the following information in the order of execution of the dives:
- The number of each dive according to Part Five, Articles 1.4.1 to 1.4.6.
  - The execution or position of the dive according to Part Five, Article 1.4.7.
  - The degree of difficulty as determined by the Formula described in Part Five, Article 1.5.
- 4.8** The dives in each round shall be executed by all the divers consecutively, according to the starting order.
- 4.9** The statement of dives shall take precedence over the scoreboard and any announcement.

## **5 COMPETITION PROCEDURE**

### **5.1 Control of Competition**

- 5.1.1** Every competition shall be controlled by a Referee, supported by Assistant Referees, together with Judges and a Secretariat.
- 5.1.2** The number of the dive to be performed and the position of execution shall be displayed on an indicator board visible to both divers and judges.
- 5.1.3** A computer programme with adequate capability to produce a judging analysis shall be used.
- 5.1.4** When electronic scoring equipment is not available the judges must have flash cards to display their awards. These flash cards must be capable of showing awards from 0 to 10 by half points.

### **5.2 Composition of the Judges Panels**

- 5.2.1** Whenever possible, seven (7) judges from different Federations shall be used.
- 5.2.2** If not enough judges are available, five (5) judges from different Federations may be used.
- 5.2.3** The Referee shall place the judges on one side of the platform (for detailed specifications see Part Five, Article 11.1.5).
- 5.2.4** Once placed, a judge shall not change position unless at the discretion of the Referee, and then only in exceptional circumstances.
- 5.2.5** When a judge is unable to continue to function after the competition has started, this judge shall be replaced by the reserve judge, preferably at the end of a round.
- 5.2.6** After each dive, on a signal given by the Referee, each judge shall immediately and simultaneously, without communicating with one another, and in a distinct manner, indicate the award for the dive. When an electronic judging device is used, the judges shall enter their awards into their electronic score pads immediately after the performance of the dive.
- 5.2.7** The judges' awards shall be displayed on the electronic scoreboard, preferably unseen by the judges. The awards (without any other information about the standing of the competition) must be seen by the judges on their electronic score pads.

## **6 DUTIES OF THE REFEREE AND ASSISTANT REFEREES**

- 6.1** The Referee shall be in control of the competition and located in a position so that the Referee can manage the competition and ensure that the Rules are observed.
- 6.2** The Referee may designate Assistant Referees.
- 6.3** **Duties of the Referee before the competition**



**6.3.1** The Referee shall inspect the statements of dives. If the statement does not comply with the Rules, the Referee shall have it corrected before the beginning of the competition but in accordance with the rules of the event.

**6.3.2** The diver shall be informed of the Referee's decision, that a correction is required, as soon as possible.

**6.4 Duties of the Referee during the competition**

**6.4.1** In the case of unforeseen circumstances, the Referee may declare a short break, a postponement or a discontinuation of the competition. If possible, the break should be done after a full round of dives.

**6.4.2** Following an interruption, the competition shall be continued from where it was stopped. The points scored before the interruption shall be carried forward into the remaining portion of the competition, whenever it is held. The final results must be based on the last complete round of dives.

*NOTE: If the competition cannot be continued, the result will be determined by the Jury of Appeal.*

**6.4.3** When there is a strong wind, the Referee may give a diver the right to make a re-start without deduction of points.

**6.4.4** Before each dive, the official announcer shall announce in the language of the host country the name of the diver and the dive to be executed. If a scoreboard is used, all information concerning the dive shall be displayed and the announcement may be restricted to the identification of the diver.

**6.4.5** When a dive is incorrectly announced, the diver or their representative shall advise the Referee immediately, who shall then confirm the diver's statement of dives.

**6.4.6** If the incorrectly announced dive is executed by the diver, the Referee may cancel it and have the correct dive announced and performed immediately. The awards for the first dive must be noted should a protest be lodged.

**6.4.7** The dive shall be executed after a signal given by the Referee. The signal shall be given as soon as the diver has checked the position of the safety swimmers and has informed the Referee that they is ready to perform the dive, and after the Referee has checked the indicator board.

**6.4.8** Each diver shall be given sufficient time for the preparation and execution of the dive. If it takes more than one minute after the Referee has given a warning, the diver shall receive zero (0) points for the dive announced.

**6.4.9** When a diver refuses to execute a dive, the Referee shall declare a failed dive.

**6.4.10** If a diver in a competition disturbs a contest, the Referee may exclude this diver from that competition. If a member of a team, a coach or an official disturbs a contest; the Referee may exclude that person from the competition area.

**6.4.11** The Referee may remove any judge from the competition whose judgement the Referee regards as unsatisfactory and may appoint another judge to replace this judge. At the end of the competition the Referee shall make a written report to the Jury of Appeal.

**6.4.12** Such a change of judge shall take place only at the end of a session or round of dives.

**6.5 Duties of the Referee during the dive**

**6.5.1** When the Referee is certain that a diver has performed a dive of a number other than that announced, the Referee shall declare it a failed dive.

**6.5.2** When it is quite clear that the dive has been performed in a position other than that announced, the Referee shall repeat the announcement, and declare that the maximum award shall be 2 points, before giving the judges the signal to show their marks. If a judge then awards more than 2 points, the Referee shall declare the award from that judge to be 2 points.

**6.5.3** When a dive is performed with a break of position during the flight, the Referee shall declare the maximum award to be 4 ½.

**6.5.4** When the Referee is certain that a diver has performed a dive with one (1) back or reverse somersault in the straight position where this straight position is shown for less than 270° (3/4 of a somersault), the Referee shall declare it a failed dive.

**6.5.5** When the Referee is certain that in a dive with a flying action, the straight position is not shown for at least (90°), the Referee shall declare a maximum award of 4 ½ points.



- 6.5.6** If during the execution of a dive, a diver is unsafely close to the platform or touches the end of the platform with their head, the Referee shall declare a maximum award of 2 points. Preferable the Referee's decision is based on a measurement of the distance by a camera.
- 6.5.7** When a twist is greater or less than 90° at the entry, the Referee shall declare it a failed dive.
- 6.5.8** When one or both arms are held above the shoulder line at the entry, the Referee shall declare the maximum award to be 4½ points. If a judge then awards more than 4 ½ points, the Referee shall declare the award from that judge to be 4½ points.
- 6.5.9** During the execution of a dive, there shall be no assistance given to the diver from any person. Assistance between dives shall be permitted.
- 6.5.10** The Referee may declare a dive to be failed if they considers that assistance has been given to the diver after the starting signal.
- 6.5.11** When there is a restart in a running, standing or armstand dive, the Referee shall deduct 2 points from the award of each judge.
- 6.5.12** When a second attempt (a re-start) is unsuccessful the Referee shall deduct 4 points from the award of each judge.
- 6.5.13** When a third attempt is unsuccessful, the Referee shall declare a failed dive.

**6.6 Duties of the Referee after the competition**

- 6.6.1** At the end of the competition the Referee shall confirm the final results by the signature.

**6.7 Duties of the Assistant Referees**

- 6.7.1** The Assistant Referee, positioned on the platform, shall:
- observe if the armstand is executed as prescribed,
  - observe the air speed indicator,
  - fulfil any other task delegated from the Referee to the Assistant Referee.
- 6.7.2** The Assistant Referee, positioned on the platform, shall report to the Referee:
- a re-start or failed dive in an armstand dive,
  - when the average wind speed exceeds 40 km per hour.

**7 DUTIES OF THE SECRETARIAT**

- 7.1** The records of the competitions shall be kept by two independent secretaries.
- 7.2** In order to facilitate the scoring, a computer, a rapid calculator, or a chart may be used.
- 7.3** The judges' awards shall be announced in their seating order and the first secretary shall record all awards as announced on the diver's statement of dives. When a computer and a scoreboard are used, the announcement of the judges' awards is not necessary and the secretary may record the awards directly from the monitor.
- 7.4** The second secretary shall enter the judges' awards on the diver's statement of dives. When a computer is used to determine the scores, the second secretary may record the awards directly from the monitor.
- 7.5** When seven (7) judges are used the secretaries shall cancel the two (2) highest and the two (2) lowest judges' awards. When more than two (2) awards are equal only two of the equal awards shall be cancelled. If only five (5) judges are used, the secretaries shall cancel the highest and the lowest award.
- 7.6** The secretaries shall independently add the remaining awards and multiply this total by the degree of difficulty for the dive to determine the score of the dive according to the following examples:

<b>Five (5) judges:</b>	8.0, 7.5, 7.5, 7.5, 7.0 = 22.5 x 3.8 = 85.5
<b>Seven (7) judges:</b>	8.0, 7.5, 7.5, 7.5, 7.5, 7.5, 7.0 = 22.5 x 3.8 = 85.5



- 7.7** When a judge by reason of illness or any other unforeseen circumstances, has made no award for a particular dive, the average of the awards of the other judges shall be adopted as the missing award. The award shall be rounded up or down to the nearest half point or whole point. Averages ending in .01 to .24 shall be lost. Averages ending in .25 to .74 shall be rounded to .50. Averages ending in .75 or higher shall be rounded up to the next whole point.
- 7.8** At the end of the competition the two secretaries shall compare the score sheets.
- 7.9** The result of the competition shall be obtained from the score sheets.
- 7.10** If electronic officiating equipment is in use, it is allowable to use only one secretariat. The secretariat records the awards and the electronic result only, to make sure that the final result can be calculated in a case that the electronic officiating equipment breaks down.
- 7.11** The final result shall be announced in one of the official languages of World Aquatics (English or French).

## **8 JUDGING**

### **8.1 General**

- 8.1.1** A judge, seated at the side of the platform, shall award from 0 to 10 points for a dive according to their overall impression within the following criteria:

<b>Excellent</b>	10
<b>Very Good</b>	8.5 – 9.5
<b>Good</b>	7.0 – 8.0
<b>Satisfactory</b>	5.5 – 6.5
<b>Deficient</b>	4.0 – 5.0
<b>Very Deficient</b>	2.5 – 3.5
<b>Unsatisfactory</b>	0.5 – 2.0
<b>Completely failed</b>	0

- 8.1.2** When judging a dive, the judge must not be influenced by any factor other than the technique and execution of the dive. The dive must be considered without regard to the approach to the starting position, the difficulty of the dive, or any movement beneath the surface of the water.
- 8.1.3** The points to be considered in judging the overall impression of a dive are the technique and grace of:
- the starting position and the take-off
  - the flight
  - the entry

### **8.2 Starting position**

- 8.2.1** The starting position in standing dives shall be assumed when the diver stands at the front edge of the platform, in a running dive when the diver is ready to take the first step of the run and in an armstand dive when both hands are on the front end of the platform and both feet are off the platform.
- 8.2.2** When, in an armstand dive, a stationary and steady balance in the straight vertical position is not shown, each judge shall deduct from ½ to 2 points, according to their opinion.
- 8.2.3** A re-start shall be allowed when a diver:
- in a standing or running dive stops and then continues,
  - in an armstand dive loses the balance, one or both feet return to the platform, or any other part of the body other than the hands touches the platform,
  - in an armstand dive loses the balance and moves one or both hands from the original position at the front end of the platform.
  - This shall be deemed a re-start and the Referee shall declare a 2 point deduction from each judge and a 4 point deduction after the second re- start.

**8.3 The take-off**

**8.3.1** The take-off in forward dives may be performed either standing or running at the option of the diver. The take-off in backward, reverse and inward dives must be performed standing.

**8.3.2** The take-off shall be balanced, powerful and with an appropriate distance to the platform.

**8.3.3** When the take-off is not balanced, powerful and with an appropriate distance to the platform, the judges shall deduct from ½ to 2 points according to their opinion.

**8.3.4** In dives with twist, the twisting shall not be manifestly done from the platform. If the twisting is manifestly done from the platform, the judges shall deduct ½ to 2 points, according to their opinion.

**8.3.5** Crow-hop: A crow-hop, before leaving the platform on backward standing dives, is a potentially dangerous movement. If a diver shows a crow-hop, the judges shall deduct 0.5 to 2 points, according to their opinion.

**8.4 The flight**

The dive can be executed in the following positions:

**8.4.1 Straight (A)**

**8.4.1.1** In the straight position, the body shall not be bent either at the knees or hips. The feet shall be together and the toes pointed. The position of the arms is at the option of the diver.

**8.4.1.2** If the straight position is not shown as prescribed, the judges shall deduct from ½ to 2 points, according to their opinion.

**8.4.1.3** In dives with one (1) back or reverse somersault in the straight position, the straight position must be shown for at least 270° (¾ of a somersault), otherwise the judges may award zero (0) points, notwithstanding that the Referee has not declared it to be a failed dive.

**8.4.2 Pike (B)**

**8.4.2.1** In the pike position, the body shall be bent at the hips, but the legs must be kept straight at the knees, the feet shall be together, and the toes pointed. The position of the arms is at the option of the diver.



*These diving illustrations serve as a guide only and the position of the arms is at the choice of the diver except in the entry.*

**8.4.2.2** If the pike position is not shown as prescribed, the judges shall deduct from ½ to 2 points, according to their opinion.

**8.4.3 Tuck (C)**

**8.4.3.1** In the tuck position, the body shall be compact, bent at the knees and hips with the knees and feet together. The hands shall be on the lower legs and the toes pointed.



*These diving illustrations serve as a guide only and the position of the arms is at the choice of the diver except in the case of the hands in the tuck and the entry.*

**8.4.3.2** If the tuck position is not shown as prescribed, the judges shall deduct from ½ to 2 points, according to their opinion.

**8.4.4 Free position (D)**

**8.4.4.1** In the free position, the body position is optional but the legs shall be together and the toes pointed.

**8.4.4.2** In somersault dives with twist, the twist may be performed at any time during the flight.

**8.4.4.3** If the free position is not shown as prescribed, the judges shall deduct from ½ to 2 points, according to their opinion.



**8.4.5 Three (3) positions (E)**

**8.4.5.1** During the dive all three positions (A, B and C) must be shown. The straight position (A) must be shown as second position.

**8.4.5.2** If the 3 positions are not shown as prescribed, judges shall deduct from ½ to 2 points, according to their opinion.

**8.4.6 Flying (F)**

**8.4.6.1** In all flying dives a straight position shall be clearly shown and that position shall be assumed from the take-off. When the straight position is not shown for at least one quarter of a somersault (90°) the maximum award by the judges shall be 4½ points, notwithstanding that the Referee has not declared maximum 4 ½ points.

**8.4.6.2** When a diver touches the platform during the flight with the feet or hands, the judges shall deduct according to their opinion.

**8.4.6.3** When a diver is unsafely close to the platform or touches the end of the platform during the flight with the head, the judges shall award up to 2 points, notwithstanding that the Referee has not declared a maximum award of 2 points. If the majority of the judges (at least three (3) in a 5 judge panel / at least four (4) in a 7 judge panel) award two (2) or less points, all higher scores shall be two (2) points.

**8.4.6.4** When a judge considers that a dive of a different number has been performed the judge may award zero (0) points, notwithstanding that the Referee has not declared it to be a failed dive.

**8.4.6.5** When a dive is performed clearly in a position other than that announced the dive shall be deemed unsatisfactory. The highest award for such a dive is 2 points, notwithstanding that the Referee has not repeated the announcement and declared maximum 2 points.

**8.4.6.6** When a dive is performed with a break of position during the flight, the highest award for such a dive is 4 ½ points, notwithstanding that the Referee has not declared maximum 4 ½ points.

**8.4.6.7** When a dive has a break in the position just at or before the entry, the judges shall deduct from ½ to 3 points, according to their discretion.

**8.5 The entry**

**8.5.1** The entry into the water shall in all cases be vertical, not twisted, with the body straight and the feet together.

**8.5.2** When the entry is short or over or twisted the judges shall deduct according to their opinion

**8.5.3** At the entry the arms shall be at the body below the navel. If one or both arms are held above the shoulder line on entry, the highest award for such an entry is 4½ points, notwithstanding that the Referee has not declared maximum 4½ points.

**8.5.4** Other than as provided in Part Five, Article 8.5.3, when the arms are not in the correct position, the judges shall deduct from ½ to 2 points, according to their opinion.

**8.5.5** When a twist is greater or less than that announced by 90 degrees or more, the judges shall award zero (0) points, notwithstanding that the Referee has not declared it to be a failed dive.

**8.5.6** The dive is considered to have been completed, when the whole of the body is completely under the surface of the water.

**9 SUMMARY OF THE PENALTIES**
**9.1 Referee to declare "Failed Dive"; 0 points**

Part Five, Article 6.4.8 If a diver use more than one minute after the Referee has given warning.

Part Five, Article 6.4.9 If a diver refuses to execute a dive.

Part Five, Article 6.5.1 If a diver has performed a dive of a number other than that announced.

Part Five, Article 6.5.4 If in a back or reverse somersault in the straight position the straight position is shown for less than 270° (3/4 of a somersault).

Part Five, Article 6.5.7 If a twist is more or less than 90° at the entry than that announced.

Part Five, Article 6.5.10 If assistance has been given to the diver after the starting signal.



Part Five, Article 6.5.13 When a third attempt (a re-start) is unsuccessful.

**9.2 Referee to declare "2 points deduction"**

Part Five, Article 6.5.10 (also Article 8.2.3) If there is a re-start in a standing, running, or armstand dive.

**9.3 Referee to declare "4 points deduction"**

Part Five, Article 6.5.11 If there is a second re-start in a standing, running, or armstand dive.

**9.4 Referee to declare "2 points maximum"**

Part Five, Article 6.5.2 If a diver performs a dive in a position other than that announced.

Part Five, Article 6.5.5 If a diver is unsafely close to the platform or touches the platform with the head.

**9.5 Referee to declare "4 ½ points maximum"**

Part Five, Article 6.5.3 If a dive is performed with a break of position during the flight.

Part Five, Article 6.5.4 If the straight position in a dive with flying action is not shown for at least 90°.

Part Five, Article 6.5.7 If a diver held one or both arms above the shoulder at the entry.

**9.6 Judges to award "0 points"**

Part Five, Article 8.6.4 If a dive of a different number was executed.

Part Five, Article 8.5.5 If a twist is greater or less than that announced by 90° or more.

Part Five, Article 8.4.1.3 If in a back or reverse somersault in the straight position, the straight position is shown for less than 270° (3/4 of a somersault).

**9.7 Judges to award "2 points maximum"**

Part Five, Article 8.4.6.3 If a diver is unsafely close to the platform or touches the platform with the head.

Part Five, Article 8.4.6.5 If a dive is performed clearly in a position other than that announced.

**9.8 Judges to award "4 ½ points maximum"**

Part Five, Article 8.4.6.1 If in a flying dive, a straight position is not clearly shown for at least one-quarter of a somersault (90°).

Part Five, Article 8.4.6.6 If a dive is performed with a break of position during the flight.

Part Five, Article 8.5.3 If the arms are above the shoulder line at the entry.

**9.9 Judges to deduct "from ½ to 2 points"**

Part Five, Article 8.2.2 If in an armstand dive, a stationary and steady balance in the straight vertical position is not shown.

Part Five, Article 8.3.3 If the take-off is not balanced, powerful and with an appropriate distance to the platform.

Part Five, Article 8.3.4 If in a twist, the twisting is manifestly done from the platform.

Part Five, Article 8.3.5 if there is a crow-hop.

Part Five, Article 8.4.1.2 If the straight position is not shown as prescribed.

Part Five, Article 8.4.2.2 If the pike position is not shown as prescribed.

Part Five, Article 8.4.3.2 If the tuck position is not shown as prescribed.

Part Five, Article 8.4.4.3 If the free position is not shown as prescribed.

Part Five, Article 8.4.5.2 If the 3 positions are not shown as prescribed.

Part Five, Article 8.5.4 If the arms are not in the correct position at the entry.

**9.10 Judges to deduct "from ½ to 3 points"**

Part Five, Article 8.4.6.7 If there is a break in the position at, or just before, the entry.

**9.11 Judges to deduct "according to individual opinion"**

Part Five, Article 8.4.6.2 If a diver touches the platform during the flight with the feet or hands.

Part Five, Article 8.5.2 If the entry is short or over or twisted.

**10 AGE GROUP RULES**

**10.1** World Aquatics Competition Regulations will apply in all age group competitions.

**10.2 Age Categories**

All age group high divers remain qualified from the 1st of January to midnight of the following 31<sup>st</sup> of December in the year of competition.

**10.3 High Diving Events**
**10.3.1 Group A**

**10.3.1.1** Age: 17, 18 or 19 years on December 31<sup>st</sup> of the year of the competition.

*Note: The divers at the age of 18 or 19 years would not be restricted from diving in the senior events if they are competent to do so.*

**10.3.1.2 Competition Format**
**10.3.1.2.1 Girls' and Boy's Platform 15 meter**

This competition shall comprise four (4) different dives from at least three (3) groups.

Two (2) dives with an assigned degree of difficulty of 2.5 and two (2) dives without limit of degree of difficulty.

At least one (1) dive must have a Barani and at least one (1) dive must have a back or reverse rotating entry.

**10.3.2 Group B**

**10.3.2.1** Age: 15 or 16 years on December 31<sup>st</sup> of the year of the competition.

**10.3.2.2 Competition Format**
**10.3.2.2.1 Girls' and Boy's Platform 12 meter**

This competition shall comprise four (4) different standing dives from at least two (2) groups.

Two (2) dives with an assigned degree of difficulty of 2.4 and two (2) dives without limit of degree of difficulty.

At least one (1) dive must have a Barani and at least one (1) dive must have a back or reverse rotating entry.

**10.4 General Rules for World Aquatics Junior High Diving Championships**

**10.4.1** World Aquatics Junior High Diving Championships shall be conducted every two years in Groups A and B.

**10.4.2** Each Federation is entitled to enter a maximum of three (3) divers in each event.

**10.4.3** The divers shall only compete in their age group.

**10.4.4** The divers shall perform a full list of dives as indicated in their age group.

**10.4.5** Each event shall be a direct final competition, irrespective of the number of entrants.

**10.4.6** In the fourth and final round, the divers will start in the reverse order of their ranking after the third round.

**10.4.7** The program schedule shall be agreed by the Bureau upon recommendation of the Technical High Diving Committee.

**10.4.8** Preferably seven (7) judges shall officiate.

**10.4.9** The Championships shall be conducted in the period of two (2) days or three (3) days.



## 11 HIGH DIVING FACILITIES AND EQUIPMENT

### 11.1 High Diving Facilities

#### 11.1.1 General requirements and definitions

World Aquatics High Diving is preferably performed in controlled environments with customised from fabricated diving towers in conjunction with fabricated pools. Rectangular dimensions are the preferred option for permanent artificial pools. Temporary round pools can be used in special circumstances.

High Diving can also be performed from fabricated platforms on existing buildings or natural cliff faces into open water (sea, lakes or rivers etc). Special permission and guidance is required from World Aquatics under these circumstances.

Dimensions in metres for all high diving facilities as detailed in the Part Five, Appendix 2 and Appendix 3, shall be observed. The Diagrams in Part Five, Appendices 1, 2, 3, 4 and 5, are established by the World Aquatics experts in cooperation with the World Aquatics THDC and approved by the World Aquatics Bureau.

In special surroundings the dimensions and requirements can be adjusted to the local situation upon recommendation by the World Aquatics facilities experts and the World Aquatics THDC and approved by the World Aquatics Bureau.

Security: The dimensions of these facilities are only for the use of expert athletes and they are not suitable for public use. It is required by the OCs and local authorities to provide security guards and / or lockable structures or gates to prevent any unauthorised persons to climb the diving towers.

#### 11.1.2 Platform High Diving

11.1.2.1 Each platform shall be rigid and horizontal.

11.1.2.2 The dimensions of the platform shall be:

Platform	Width	Length
3 m	2.00 m (1.50 m *)	5.00 m (2.0 m *)
5 m	2.00 m (1.50 m *)	5.00 m (2.0 m *)
7.5 m	2.00 m (1.50 m *)	5.00 m (2.0 m *)
10 m	2.00 m (1.50 m *)	5.00 m (2.0 m *)
15 m (11 m – 19 m)	2.00 m (1.50 m *)	5.00 m (2.0 m *)
20 m	2.00 m	5.00 m
21 m – 26 m	2.00 m (1.50 m *)	5.00 m (2.0 m *)
27 m	2.00 m	5.00 m

\* Accepted for events other than World Aquatics Championships and High Diving World Cups

11.1.2.3 The thickness of the front edge of the platform shall not exceed 0.20 metre and can be vertical or inclined at an angle not greater than 10° to the vertical inside the plummet line.

11.1.2.4 The entire surface of all platforms shall be covered with slip-resistant material that shall have a tread pattern that provides sufficient friction in wet and dry conditions such that the divers are prevented from slipping when performing dives in all directions.

11.1.2.4.1 If an unknown surface material is proposed, a physical sample must be sent to the World Aquatics THDC for testing and approval before it can be used.

11.1.2.4.2 Terracotta is the preferred colour of the platform surface material. Black, white and blue coloured surface material is not permitted.

11.1.2.4.3 The colour of the carpet on the pool deck must not be blue. Grey is the preferred option.

11.1.2.5 The back and sides of each platform shall be surrounded by handrails up to 1m from the edge of the platform with a minimum clearance of 1.8 metres between vertical pairs. The minimum height shall be 1.0 metre and they shall be with at least two horizontal crossbars placed outside the platform beginning 1.00 metre from the front edge of the platform.

11.1.2.6 Each platform shall be accessible by suitable slip-resistant stairs (not ladders) as required by the country's building regulations and or health and safety standards that are applicable.



- 11.1.2.7** It is preferable that a platform is not constructed directly under any other platform however in circumstances where this cannot be avoided then the dimensions in Part Five, Article 11.5.2 (Appendix 2) must be observed.
- 11.1.2.8** The platform shall be a concrete, steel or other rigid material construction as approved by World Aquatics. The longitude and latitude movement/oscillation allowance for the entire 27 metres high tower structure shall be 2.7 cm (1/1000 from 27m). The maximum wind speed for the tower oscillation stability is 54km/hour (banners will affect the stability). The downward flex at the diving end of the platform shall not exceed 2-3mm and approved by the local authority of the area.
- 11.1.3** **General Requirements**
- 11.1.3.1** For High Diving platforms designed and constructed after 31st December 2017 the minimum dimensions in metres for high diving facilities as detailed on the tables in Appendix 2 and Appendix 4 shall prevail, using, as a basic measuring point of reference, the plummet line, which is a vertical line extending through the centre of the front edge of the platforms.
- 11.1.3.2** The platforms shall face north in the northern hemisphere and south in the southern hemisphere where possible.
- 11.1.3.3** The water temperature should be not less than 18°C in open water venues and preferable not less than 26°C degrees in venues with an artificial pool.
- 11.1.3.4** A certificate of suitability for use of the venue shall be issued by the appropriate local health and safety authorities. In general terms the certification must also relate to the general water quality for human use.
- 11.1.3.5** The surface agitation shall be done by a strong horizontal water spray and the scuba divers must also provide additional splash when necessary. The water spray must not be mounted higher than 1.50m above the water level. The water spray should be strong and provide foamy white water for better visibility for the athletes. The spray or the foam must be strong enough to cover the landing area.
- 11.1.3.6** If the wind speed exceeds 40kph (kph= kilometre per hour) then the Referee shall decide if the competition can continue or must be interrupted until the wind speed is below 40kph. A transportable air speed indicator must be available for use on the 20m and 27m platforms.
- If lightning strikes are within 3km of the dive site then the training or the competition must be suspended until the storm distance is greater than 3km.
- 11.1.4** **Security and Emergency Rescue Requirements**
- 11.1.4.1** To take into consideration the different facilities in High Diving (natural surroundings with open water, temporary or permanent facilities with artificial pools and clear water and line of site of the pool), the security and emergency rescue requirements may vary.



**11.1.4.2** The requirements for different High Diving facilities are described in the following table.

	Facilities with open water		Temporary Facilities with artificial pool <sup>8)</sup>		Permanent Facilities	
	Training	Competition	Training	Competition	Training	Competition
<b>Medical staff</b>						
Doctors <sup>1)</sup>	1 to 2	2	1 to 2	2		1 to 2
Staffed ambulance	1	2	1	2	<sup>2)</sup>	1 to 2
Designated hospital <sup>3)</sup>	1	1	1	1	1	1
<b>Safety Team</b>						
Safety captain	1	1	1	1	4)	1 <sup>5)</sup>
Scuba diver	1	1	1 <sup>6)</sup>	1 <sup>6)</sup>		1 <sup>6)</sup>
Apnea swimmer	3	3	2	2		2 <sup>5)</sup>
Reserve apnea sw.	2 to 3	2 to 3	1 to 2	2		1 to 2 <sup>5)</sup>
<b>Rescue equipment</b>						
Rescue boats	2	2				
Spinal boards	2	2	2	2	2	2
Stiff neck collars	5	5	5	5	5	5
Defibrillators	2	2	2	2	2	2
Oxygen tanks	2	2	2	2	2	2
Blankets	4 to 5	4 to 5	4 to 5	4 to 5	4 to 5	4 to 5
General first aid kit	1	1	1	1	1	1
<b>For recovery</b>						
Ice baths <sup>7)</sup>	2	2	2	2	2	2

<sup>1)</sup> Doctors with knowledge in trauma injuries.

<sup>2)</sup> Staffed ambulance on alert within 15 minutes

<sup>3)</sup> Hospital on alert with orthopedic surgery.

<sup>4)</sup> For all High Diving training sessions from heights ranging from 10m up to 27m in permanent High Dive facilities with a constructed pool with clear water and line of site to the bottom of the pool it is recommended that at least two lifeguards should be dedicated to the High Diving pool and a third lifeguard on duty that can be called in to assist via radio, verbal call or via hand signals. The two lifeguards at the High Dive Pool should be stationed as close the pool edge as possible to minimize the response time in case of emergency. It is recommended that pool management conduct regular deep water rescue rehearsals.

<sup>5)</sup> Facilities may implement qualified local staffing to cover part of, or all of these water safety requirements.

<sup>6)</sup> In Facilities that are Temporary with an artificial pool or Permanent, the scuba safety diver is not required, unless specified by the water safety captain.

<sup>7)</sup> minimum width 0.8 m, length 1.2 m, depth 1 m or 14 ° C water tubs.

<sup>8)</sup> Upon the occasion of a Temporary Platform constructed in a Permanent facility, the Safety Requirements outlined under Permanent Facilities would apply.

### **11.1.4.3 Location of the Field of Play First Aid Treatment Area**

The Medical Station and/or the Field of Play (FoP) Treatment Area are to be designated at each competitive venue. Due to the outdoor nature of the sport, it may happen that the Medical Station will not be nearby the competition venue. Therefore, the FoP Treatment Area should be organized based on the specificity of each site. For instance, it could be a Medical Boat in sea/ocean environment or on a temporary platform where the divers exit the water.

In indoor and controlled environment, the Medical Station and/or the FoP Treatment Area are easier to set up and the Area should be clearly labelled and be within easy access from the Field of Play.

Access to ambulance transport (whatever it may be: road, boat, helicopter) should also be easily reached from the treatment area.

### **11.1.4.4 Water Safety Team, Standard Procedure for each dive**

#### **11.1.4.4.1 General instructions**



Instructions for the members of the water safety team (in the water):

- Determine the proper alignment around the point of entry of the High Divers. Return as quickly as possible to your position after any “action”.
- Find reference points to make sure you are in the right spot.
- Be aware of any currents that can pull you out of position.
- Always look up to the platform to know when the divers are planning to dive.
- The High Divers will sometimes indicate to the water safety team members to move closer or further away from the point of entry with hand signals.
- The members of the water safety team must try to see the whole dive of the High Diver. As soon as the High Diver hits the water, the members of the water safety team dive down to approximately 3 meters in the direction of the High Diver and estimate the condition of the High Diver. Thereafter they come up to the surface with the High Diver.
- Once the High Diver gives the ‘OK’ sign on the surface of the water, the water safety members return to their position quickly and look back up at the platform.

#### **11.1.4.4.2 Hazardous Entry or Landing**

If the referee calls out on the emergency channel on the radio, ‘BAD LANDING’:

- The water safety captain in the boat or on the pool deck must signal the water safety team with a loud whistle or with a hand signal to immediately secure the High Diver on a spinal board with a stiff neck collar. If the High Diver is unable to breathe, turn him/her on his/her back and keep the nose and mouth well out of the water. The High Diver must be secured on a spinal board while still in the water and only thereafter transferred onto land (deep water spinal injury management). Then proceed to the doctor’s area or ambulance immediately.
- The doctor will make the call about further treatment. This could be treatment in the competition area (and no hospitalization), or transportation to a hospital. It is highly unlikely that the doctor will allow the diver to continue competition after a bad landing.

It’s important that a designated World Aquatics representative could travel with the High Diver to the hospital.

Note: even without a bad landing a diver may sustain a serious injury or even be knocked unconscious.

It is important that High Divers are allowed to consult with medical professionals on site during the competition whether it is medically responsible to continue with the competition. High Divers can inform the referee at any time that they wish to withdraw from the competition.

#### **11.1.4.4.3 Rescue Map**

A clear evacuation path – which may vary at each event location – shall be clearly known by the rescue team.

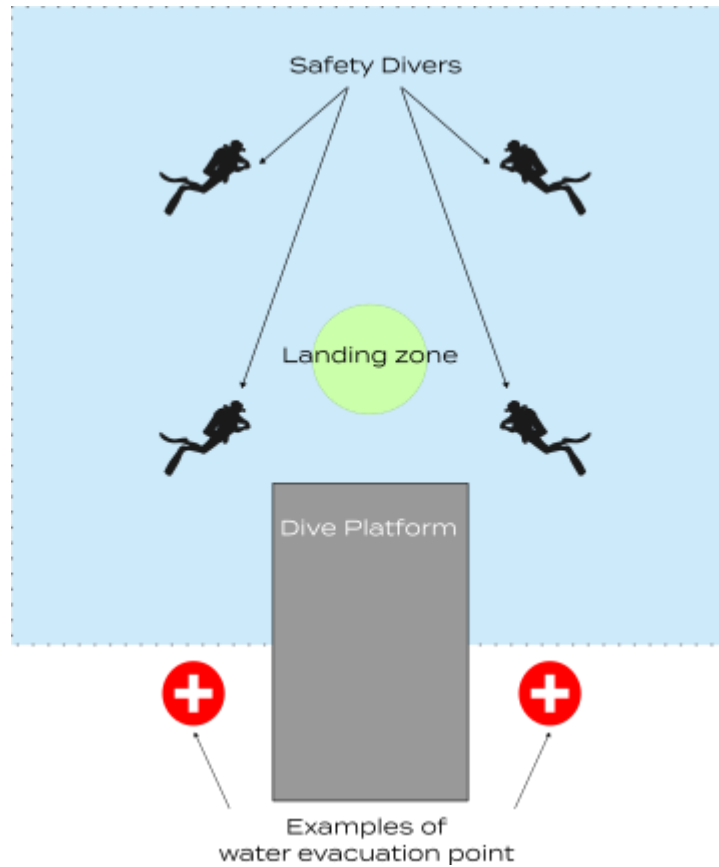

### 11.1.5 Judges Seating

**11.1.5.1** The judges shall be placed side by side in two lines on one side of the platform with the sunlight in the back or above the judges. In indoor facilities and special circumstances, the Referee may decide that the judges are placed on both sides of the platforms.

**11.1.5.2** No judge shall be seated behind the front edge of the platform.

**11.1.5.3** The judges shall be seated at a distance of not less than 30 meters and not more than 40 meters from the entry point of the platforms, and in a position elevated between three (3) and six (6) metres above the water level. Special local circumstances may influence the position of the judges.

### 11.2 High Diving Facilities for World Aquatics Championships

Provisions in Part Five, Articles 11.1 to 11.1.5.3 apply to the World Aquatics Championships.

### 11.3 Automatic Officiating Equipment for High Diving

**11.3.1** Electronic Officiating equipment records the judges awards for each diver and determines the final score for each dive as required by Part Five, Article 7.

**11.3.2** Preferred Equipment must be able to:

**11.3.2.1** Record judges awards by whole and half points.

**11.3.2.2** Be able to display all recorded and calculated information for each diver both before and after each dive.

**11.3.2.3** Be able to display the scores for all divers before and after each dive.

**11.3.2.4** Be able to display the rank order and scores for all divers after each round of dives.

**11.3.2.5** The equipment must provide each judge with an electronic judging device that will permit each judge to enter their award and to see their award on a window on the device. After the referee has accepted the judges awards, all awards shall be displayed on each electronic judging device.





- 11.3.2.6** Judges analysis is to be provided at the conclusion of each event or series.
- 11.3.2.7** The referee must be provided with a monitor on which he/she will be able to view the awards of all the judges prior to the awards then being displayed on the score board, and preferable with a video camera, to observe the divers performance if needed.
- 11.3.2.8** There is a requirement for a print out of the following information:
- The draw for the diving order.
  - A start list for each session or event.
  - A ranking of dives at the end of each round.
  - A ranking of dives at the end of each event.
  - Judges awards and scores for each diver at the end of each session and event.
- 11.4** **Dry Land Facilities**
- 11.4.1** For the safety, practice and development of high divers and competitions, it is strongly recommended that the guidelines presented below be incorporated into the facility and placed adjacent to the competitive High Diving area/facilities.
- 11.4.2** Recommended equipment in dry land area
- 1 x Trampoline, Olympic standard,
  - length 5.2 m, width 3.05 m, height 1.15 m
  - 4 x Foam Crash Mats,
  - minimum length 1.4 m, width 1.0 m, height 0.25 m
  - 2 x Somersault Boxes,
  - minimum length 1.0 m, width 1.0 m, height 0.3 m
  - 25 x Exercise mats,
  - length 1.8 m, width 0.5 m, height 0.02 m
  - 5 x Spinning Bikes
- 11.5** **APPENDICES**
- 11.5.1 APPENDIX 1 - Diagram / General Standard Facilities
- 11.5.2 APPENDIX 2 - Table / General Standard Facilities Dimensions
- 11.5.3 APPENDIX 3 - Diagram / Temporary Round Pools
- 11.5.4 APPENDIX 4 - Table / Temporary Round Pools / Dimensions
- 11.5.5 APPENDIX 5 - Diagram / General Standard Facilities combined with Diving
- 12** **DEGREE OF DIFFICULTY - FORMULA AND TABLES**
- 12.1 Degree of Difficulty - Formula and Components
- 12.2 Tables of Degree of Difficulties



**11.5.1 APPENDIX 1 - Diagram / General Standard Facilities**

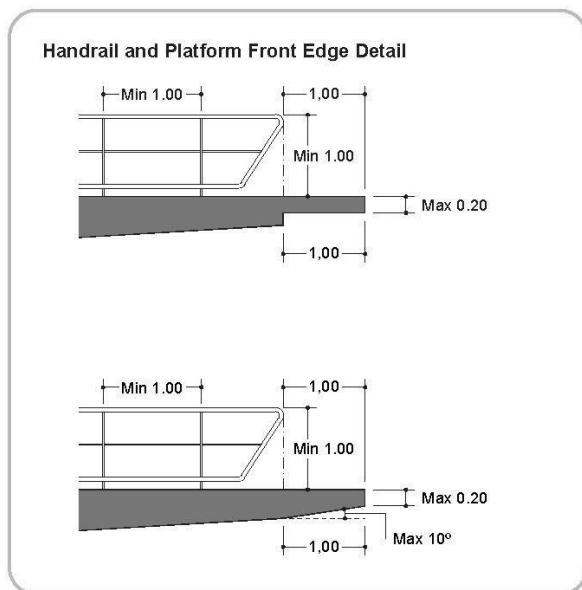
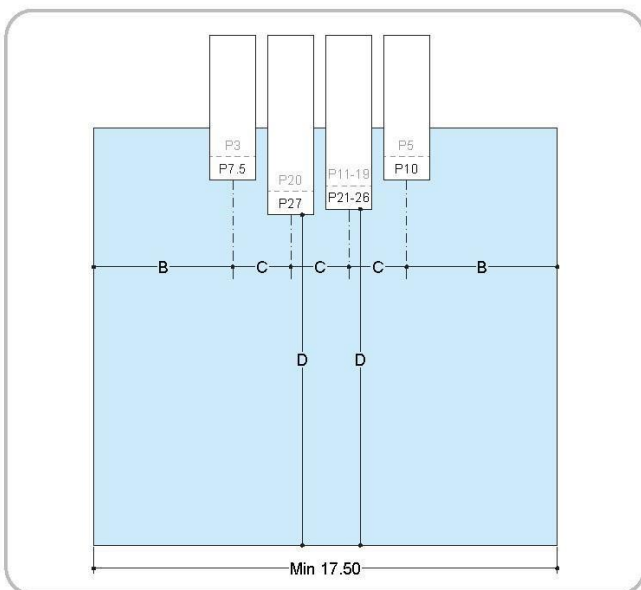
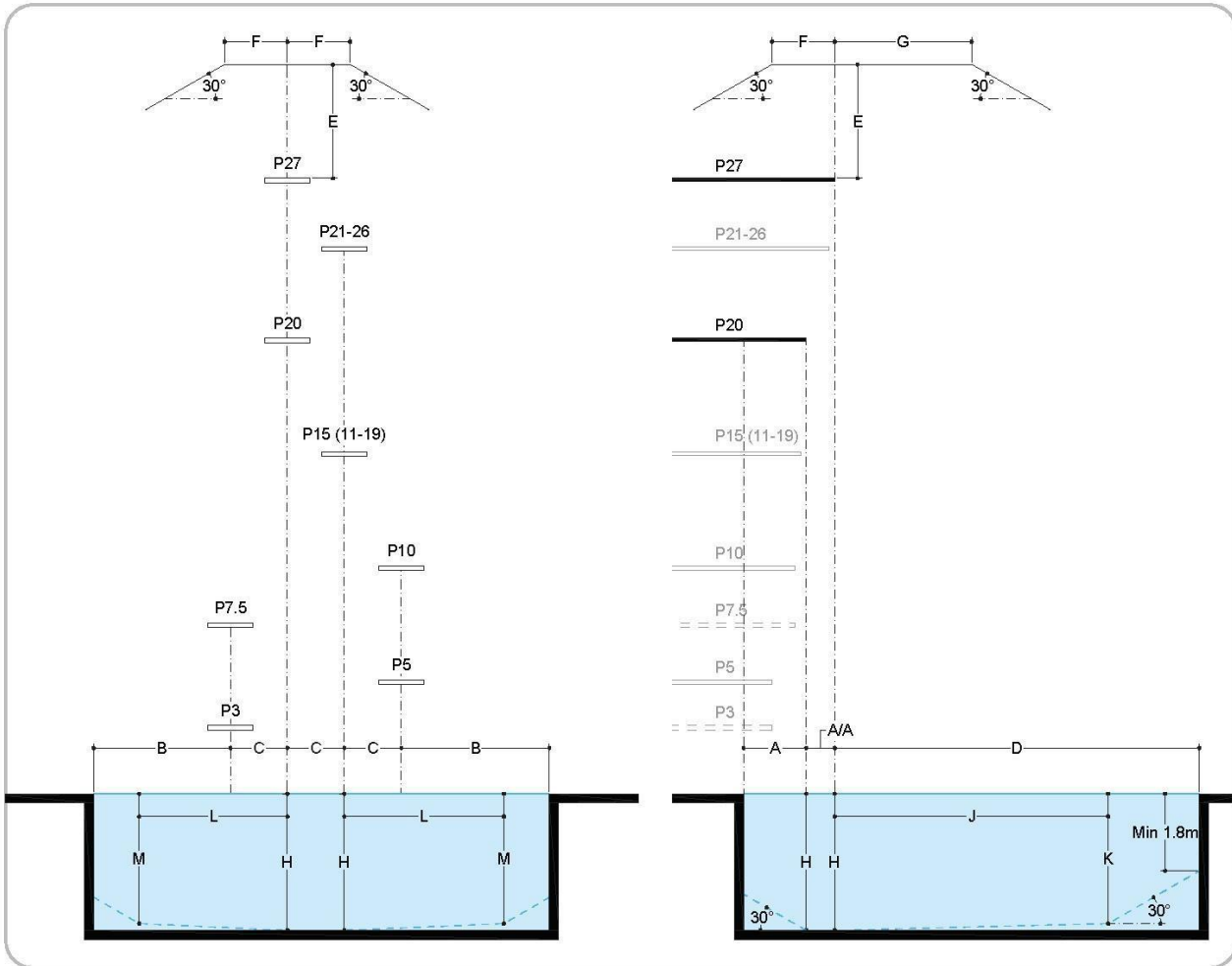



11.5.2 APPENDIX 2 - Table / General Standard Facilities Dimensions

WORLD AQUATICS Dimensions for High Diving Facilities			PLATFORM															
			P 3		P 5		P 7.5		P 10		P 15 (P 11-19) 4)		P 20		P 21-26 5)		P 27	
	Length	Minimum 2)	5.00		5.00		5.00		5.00		5.00		5.00		5.00		5.00	
	Width	Minimum 2)	2.00		2.00		2.00		2.00		2.00		2.00		2.00		2.00	
	Height		3.00		5.00		7.50		10.00		15.00		20.00		21.00 - 26.00		27.00	
Tolerance 3)		± 0.50		± 0.50		± 0.50		± 0.50		± 0.50		± 0.50		± 0.50		± 0.50		
			Horiz	Vert	Horiz	Vert	Horiz	Vert	Horiz	Vert	Horiz	Vert	Horiz	Vert	Horiz	Vert	Horiz	Vert
A	From plumbet <b>BACK TO POOL WALL or OBSTACLE</b>	Designation	A-P3		A-P5		A-P7.5		A-P10		A-P15		A-P20		A-(P21-26)		A-P27	
		Minimum	1.25		1.25		1.25		1.50		1.75		2.00		2.00		2.00	
A/A	From plumbet <b>BACK TO PLATFORM</b> plumbet directly below	Designation	A/A-P5		A/A-P7.5		A/A-P10		A/A-P15		A/A-P20		A/A-(P21-26)		A/A-P27			
		Minimum	1.00		1.00		1.00		1.00		1.00		1.00		1.00			
B	From plumbet <b>POOL WALL or OBSTACLE AT SIDE</b>	Designation	B-P3		B-P5		B-P7.5		B-P10		B-P15		B-P20		C-(P21-26)		B-P27	
		Minimum	3.50		3.75		4.50		5.50		5.50		6.00		6.50		7.00	
C	From plumbet to <b>ADJACENT PLUMBET 1)</b>	Designation	C-P3		C-P5		C-P7.5		C-P10		C-P15		C-P20		C-(P21-26)		C-P27	
		Minimum	2.50		2.50		2.50		2.50		2.50		2.50		2.50		2.50	
D	From plumbet to <b>POOL WALL or OBSTACLE AHEAD</b>	Designation	D-P3		D-P5		D-P7.5		D-P10		D-P15		D-P20		D-(P21-26)		D-P27	
		Minimum	9.50		10.25		11.00		13.50		14.00		14.00		15.00		15.00	
E	On plumbet, from <b>PLATFORM TO CEILING/ PLATFORM ABOVE</b>	Designation	E-P3		E-P5		E-P7.5		E-P10		E-P15		E-P20		E-(P21-26)		E-P27	
		Minimum	4.00		4.00		4.00		4.00		4.00		4.00		4.00		4.00	
F	Clear Overhead <b>BEHIND AND EACH SIDE</b> of plumbet	Designation	F-P3	E-P3	F-P5	E-P5	F-P7.5	E-P7.5	F-P10	E-P10	F-P15	E-P15	F-P20	E-P20	F-(P21-26)	E-(P21-26)	F-P27	E-P27
		Minimum	2.75	3.50	2.75	4.00	2.75	4.00	2.75	4.00	2.75	4.00	2.75	4.00	2.75	4.00	2.75	4.00
G	Clear Overhead <b>AHEAD</b> of plumbet	Designation	G-P3	E-P3	G-P5	E-P5	G-P7.5	E-P7.5	G-P10	E-P10	G-P15	E-P15	G-P20	E-P20	G-(P21-26)	E-(P21-26)	G-P27	E-P27
		Minimum	5.00	4.00	5.00	4.00	5.00	4.00	6.00	4.00	6.00	4.00	6.00	4.00	6.00	4.00	6.00	4.00
H	<b>DEPTH OF WATER</b> at plumbet	Designation	H-P3		H-P5		H-P7.5		H-P10		H-P15		H-P20		H-P24		H-P27	
		Minimum	3.60		3.80		4.00		5.00		5.00		5.00		5.00		5.00	
		Preferred	4.00		4.00		4.50		5.00		5.50		5.80		5.80		5.80	
J K	<b>DISTANCE and DEPTH</b>  <b>AHEAD</b> of plumbet for all stands	Designation	J-P3	K-P3	J-P5	K-P5	J-P7.5	K-P7.5	J-P10	K-P10	J-P15	K-P15	J-P20	K-P20	J-(P21-26)	K-(P21-26)	J-P27	K-P27
		Minimum	5.50	3.40	6.00	3.60	8.00	4.30	11.00	4.80	11.50	5.30	12.00	5.60	12.00	5.60	12.00	5.60
L M	<b>DISTANCE and DEPTH</b>  <b>EACH SIDE</b> of plumbet	Designation	L-P3	M-P3	L-P5	M-P5	L-P7.5	M-P7.5	L-P10	M-P10	L-P15	M-P15	L-P20	M-P20	L-(P21-26)	M-(P21-26)	L-P27	M-P27
		Minimum	2.30	3.40	3.50	3.60	4.50	4.30	5.25	4.80	5.50	5.30	6.00	5.60	6.50	5.60	7.00	5.60
N 30**Degrees			Maximum Slope to reduce dimensions beyond full requirements for pool depth and ceiling height =															

**Notes**

The appropriate local authorities must certify that the minimum requirements are observed.

- 1) The side distance between platforms must not be less than 0.50 metre.
- 2) For High Diving events other than World Aquatics Championships and World Aquatics World Cups the following minimum platform dimensions are accepted: Length 2.0m / width 1.5m; adjacent platform distances between platforms to be adjusted accordingly with the respect of 0.50 metre distance between the platforms.
- 3) In natural surroundings (sea, lakes, rivers etc.) height tolerance:  $\pm$  0.5 metre.
- 4) 15.00m is an official height for Junior A competitions and dimensions valid for all heights between 11.00 - 19.00 metres.
- 5) The value for a 24m platform is valid for all heights between 21.00 - 26.00 metres.



**11.5.3 APPENDIX 3 - Diagram / Temporary Round Pools**

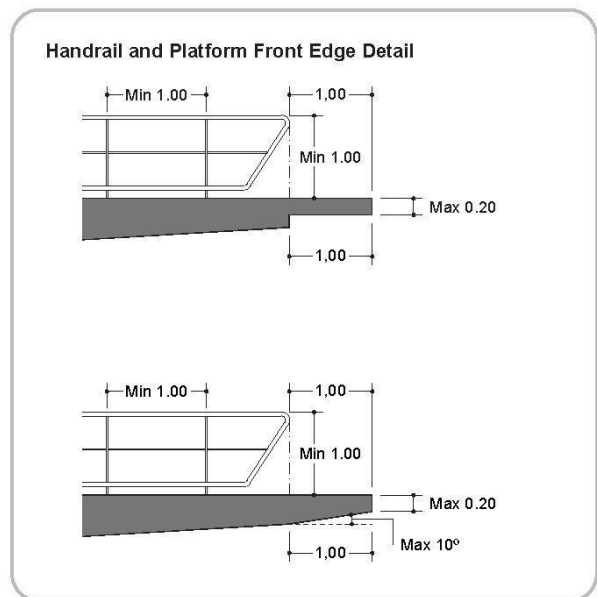
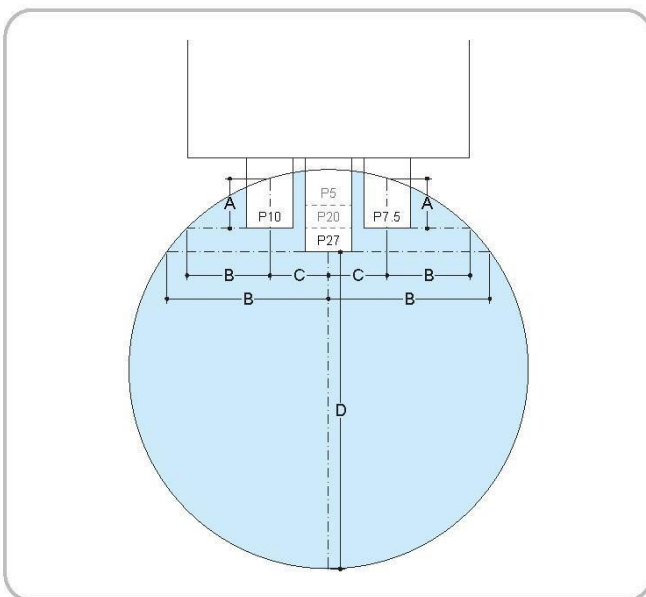
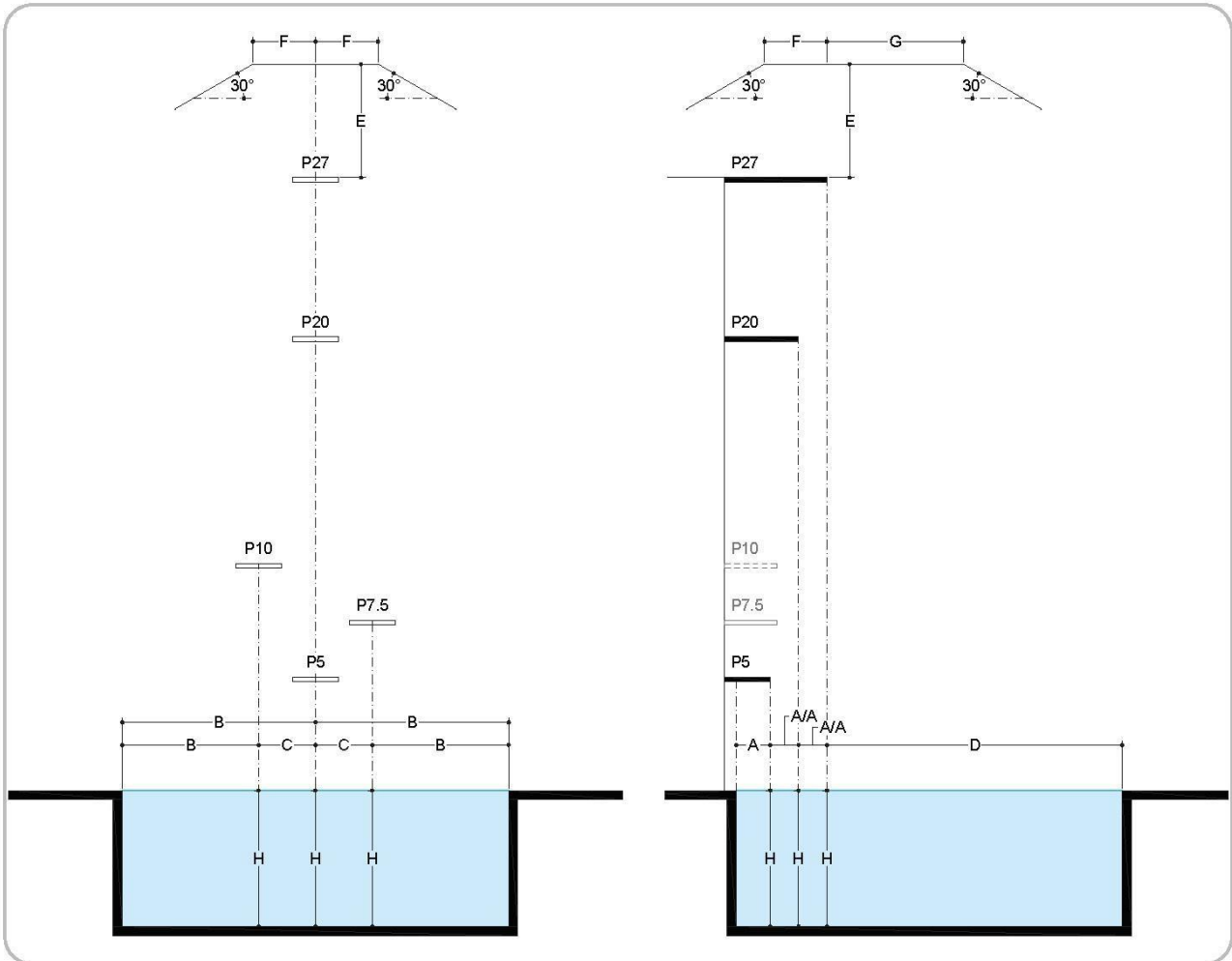

**11.5.4 APPENDIX 4 - Table / Temporary Round Pools / Dimensions**

WORLD AQUATICS Dimensions for High Diving temporary round pools			PLATFORM				
			P 5	P 7.5	P 10	P 20	P 27
Round pool diameter 17 m	Length	Minimum	5.00	5.00	5.00	5.00	5.00
	Width	Minimum	2.00	2.00	2.00	2.00	2.00
	Height		5.00	7.50	10.00	20.00	27.00
		Tolerance		± 0.05	± 0.05	± 0.05	± 0.05
<b>A</b>	From plummet <b>BACK TO POOL WALL</b>		1.50	1.85	1.85	2.25	3.00
<b>A/A</b>	From plummet <b>BACK TO PLATFORM</b> plummet direct below					0.75	0.75
<b>B</b>	From plummet to <b>POOL WALL AT SIDE</b>		4.80	3.20	3.20	5.70	6.40
<b>C</b>	From plummet to <b>ADJACENT PLUMMET <sup>1)</sup></b>		2.50	2.50	2.50	2.50	2.50
<b>D</b>	From plummet to <b>POOL WALL AHEAD</b>		14.00	14.00	14.00	14.00	14.00
<b>H</b>	<b>DEPTH OF WATER</b> at plummet		5.80	5.80	5.80	5.80	5.80

**Notes**

The appropriate local authorities must certify that the minimum requirements are observed.

<sup>1)</sup> The side distance between platforms must not be less than 0.50 metre.

The use of temporary round pools (TRP) is restricted to sanctioned World Aquatics competitions.

**Comment**

The same dimensions and configuration of the platforms can be achieved in a rectangular pool with the following dimensions: 14.00 x 17.00 metres.



**11.5.5 APPENDIX 5 - Diagram / General Standard Facilities combined with Diving**

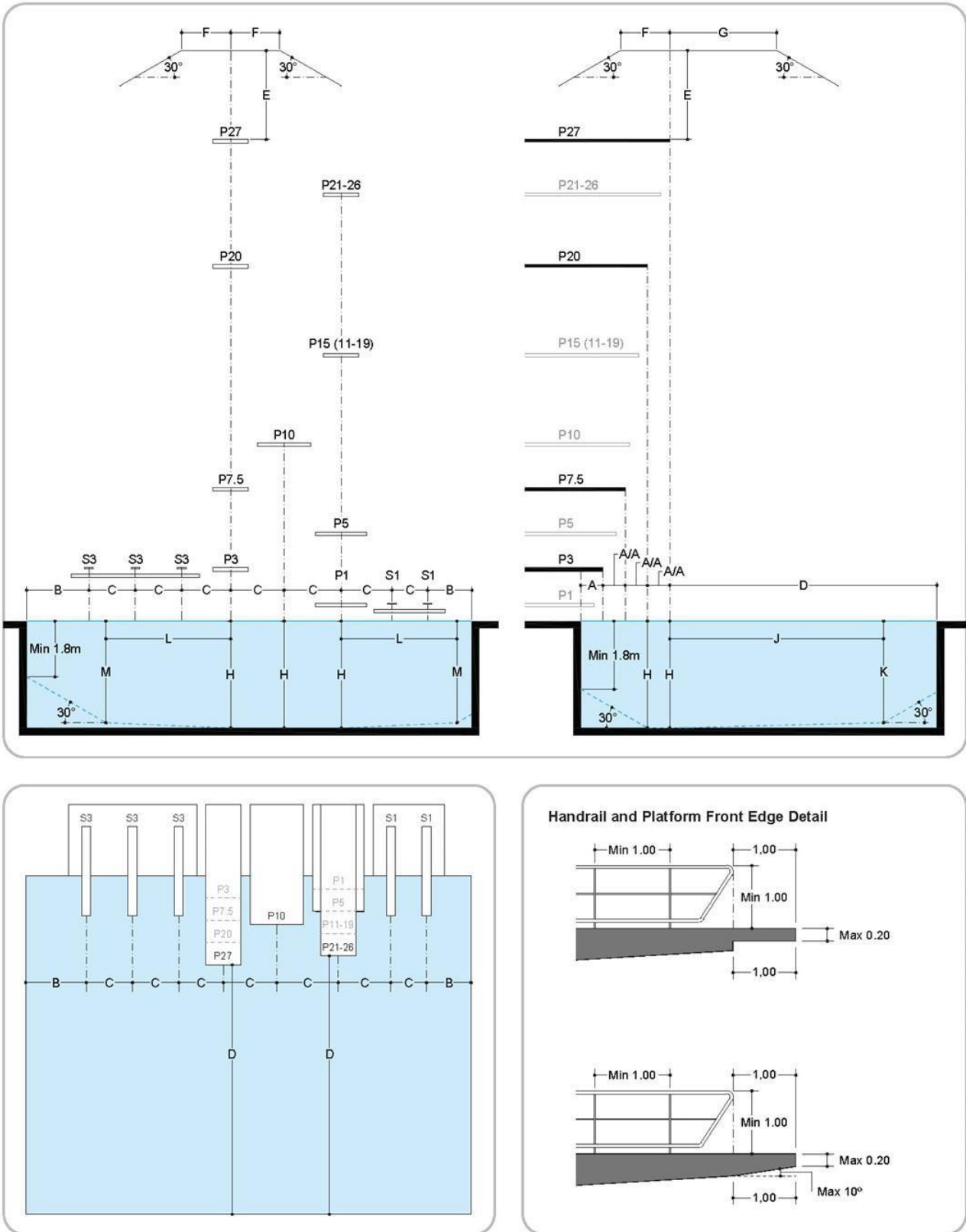



# 12 DEGREE OF DIFFICULTY - FORMULA AND TABLES

## 12.1 Degree of Difficulty - Formula and Components

### HIGH DIVING: 12 METERS

STANDING DIVES A+B+C+D+E+F=DD		ARMSTAND DIVES A+B+C+D+E+F=DD																																																																																																																																																																																																																																																																																																																																																																																																																																																																																																																					
<b>FORWARD (GROUP 1)</b> <b>1 - 51</b> A. SOMERSAULTS <table border="1"> <tr><td>2</td><td>4</td><td>6</td><td>8</td><td>10</td></tr> <tr><td>2,3</td><td>2,6</td><td>3,4</td><td>4,7</td><td>-</td></tr> </table> B. APPROACH <table border="1"> <tr><td>2</td><td>4</td><td>6</td><td>8</td><td>10</td></tr> <tr><td>0,0</td><td>0,0</td><td>0,0</td><td>0,0</td><td>-</td></tr> </table> C. TWISTS BARANI ENTRY <table border="1"> <tr><td>1/2 tw</td><td>2</td><td>4</td><td>6</td><td>8</td><td>10</td></tr> <tr><td>1</td><td>0,0</td><td>0,2</td><td>0,4</td><td>0,6</td><td>-</td></tr> <tr><td>3</td><td>-</td><td>0,5</td><td>0,9</td><td>1,5</td><td>-</td></tr> <tr><td>5</td><td>-</td><td>1,0</td><td>1,6</td><td>-</td><td>-</td></tr> <tr><td>7</td><td>-</td><td>1,7</td><td>-</td><td>-</td><td>-</td></tr> <tr><td>9</td><td>-</td><td>2,5</td><td>-</td><td>-</td><td>-</td></tr> </table> D. TWISTS BLIND ENTRY <table border="1"> <tr><td>1/2 tw</td><td>2</td><td>4</td><td>6</td><td>8</td><td>10</td></tr> <tr><td>2</td><td>-</td><td>0,8</td><td>1,3</td><td>2,1</td><td>-</td></tr> <tr><td>4</td><td>-</td><td>1,4</td><td>2,1</td><td>-</td><td>-</td></tr> <tr><td>6</td><td>-</td><td>2,2</td><td>-</td><td>-</td><td>-</td></tr> </table> E. BLIND ENTRY <table border="1"> <tr><td>1/2 ss</td><td>2</td><td>4</td><td>6</td><td>8</td><td>10</td></tr> <tr><td>0,2</td><td>0,5</td><td>0,8</td><td>1,2</td><td>-</td><td>-</td></tr> </table>		2	4	6	8	10	2,3	2,6	3,4	4,7	-	2	4	6	8	10	0,0	0,0	0,0	0,0	-	1/2 tw	2	4	6	8	10	1	0,0	0,2	0,4	0,6	-	3	-	0,5	0,9	1,5	-	5	-	1,0	1,6	-	-	7	-	1,7	-	-	-	9	-	2,5	-	-	-	1/2 tw	2	4	6	8	10	2	-	0,8	1,3	2,1	-	4	-	1,4	2,1	-	-	6	-	2,2	-	-	-	1/2 ss	2	4	6	8	10	0,2	0,5	0,8	1,2	-	-	<b>INWARD (GROUP 4)</b> <b>4 - 54</b> A. SOMERSAULTS <table border="1"> <tr><td>2</td><td>4</td><td>6</td><td>8</td><td>10</td></tr> <tr><td>2,3</td><td>2,6</td><td>3,4</td><td>4,7</td><td>-</td></tr> </table> B. APPROACH <table border="1"> <tr><td>2</td><td>4</td><td>6</td><td>8</td><td>10</td></tr> <tr><td>0,2</td><td>0,4</td><td>0,6</td><td>0,8</td><td>-</td></tr> </table> C. TWISTS BARANI ENTRY <table border="1"> <tr><td>1/2 tw</td><td>2</td><td>4</td><td>6</td><td>8</td><td>10</td></tr> <tr><td>1</td><td>0,1</td><td>0,2</td><td>0,4</td><td>0,7</td><td>-</td></tr> <tr><td>3</td><td>-</td><td>0,6</td><td>1,0</td><td>1,6</td><td>-</td></tr> <tr><td>5</td><td>-</td><td>1,2</td><td>1,8</td><td>-</td><td>-</td></tr> <tr><td>7</td><td>-</td><td>2,0</td><td>-</td><td>-</td><td>-</td></tr> <tr><td>9</td><td>-</td><td>-</td><td>-</td><td>-</td><td>-</td></tr> </table> D. TWISTS BLIND ENTRY <table border="1"> <tr><td>1/2 tw</td><td>2</td><td>4</td><td>6</td><td>8</td><td>10</td></tr> <tr><td>2</td><td>-</td><td>1,0</td><td>1,5</td><td>2,3</td><td>-</td></tr> <tr><td>4</td><td>-</td><td>1,7</td><td>2,4</td><td>-</td><td>-</td></tr> <tr><td>6</td><td>-</td><td>2,5</td><td>-</td><td>-</td><td>-</td></tr> </table> E. BLIND ENTRY <table border="1"> <tr><td>1/2 ss</td><td>2</td><td>4</td><td>6</td><td>8</td><td>10</td></tr> <tr><td>0,4</td><td>0,6</td><td>0,9</td><td>1,4</td><td>-</td><td>-</td></tr> </table>		2	4	6	8	10	2,3	2,6	3,4	4,7	-	2	4	6	8	10	0,2	0,4	0,6	0,8	-	1/2 tw	2	4	6	8	10	1	0,1	0,2	0,4	0,7	-	3	-	0,6	1,0	1,6	-	5	-	1,2	1,8	-	-	7	-	2,0	-	-	-	9	-	-	-	-	-	1/2 tw	2	4	6	8	10	2	-	1,0	1,5	2,3	-	4	-	1,7	2,4	-	-	6	-	2,5	-	-	-	1/2 ss	2	4	6	8	10	0,4	0,6	0,9	1,4	-	-	<b>FORWARD (GROUP 5)</b> <b>6 - 61</b> A1. SOMERSAULTS <table border="1"> <tr><td>1</td><td>3</td><td>5</td><td>7</td><td>9</td></tr> <tr><td>2,3</td><td>2,6</td><td>3,4</td><td>4,7</td><td>-</td></tr> </table> B1. APPROACH <table border="1"> <tr><td>1</td><td>3</td><td>5</td><td>7</td><td>9</td></tr> <tr><td>0,0</td><td>0,1</td><td>0,3</td><td>0,5</td><td>-</td></tr> </table> C1. TWISTS BARANI ENTRY <table border="1"> <tr><td>1/2 tw</td><td>1</td><td>3</td><td>5</td><td>7</td><td>9</td></tr> <tr><td>1</td><td>0,0</td><td>0,1</td><td>0,3</td><td>0,5</td><td>-</td></tr> <tr><td>3</td><td>-</td><td>0,6</td><td>1,0</td><td>1,6</td><td>-</td></tr> <tr><td>5</td><td>-</td><td>1,3</td><td>-</td><td>-</td><td>-</td></tr> <tr><td>7</td><td>-</td><td>-</td><td>-</td><td>-</td><td>-</td></tr> <tr><td>9</td><td>-</td><td>-</td><td>-</td><td>-</td><td>-</td></tr> </table> D1. TWISTS BLIND ENTRY <table border="1"> <tr><td>1/2 tw</td><td>1</td><td>3</td><td>5</td><td>7</td><td>9</td></tr> <tr><td>2</td><td>-</td><td>0,9</td><td>1,5</td><td>2,3</td><td>-</td></tr> <tr><td>4</td><td>-</td><td>1,7</td><td>-</td><td>-</td><td>-</td></tr> <tr><td>6</td><td>-</td><td>-</td><td>-</td><td>-</td><td>-</td></tr> </table> E1. BLIND ENTRY <table border="1"> <tr><td>1/2 ss</td><td>1</td><td>3</td><td>5</td><td>7</td><td>9</td></tr> <tr><td>0,1</td><td>0,4</td><td>0,8</td><td>1,2</td><td>-</td><td>-</td></tr> </table>		1	3	5	7	9	2,3	2,6	3,4	4,7	-	1	3	5	7	9	0,0	0,1	0,3	0,5	-	1/2 tw	1	3	5	7	9	1	0,0	0,1	0,3	0,5	-	3	-	0,6	1,0	1,6	-	5	-	1,3	-	-	-	7	-	-	-	-	-	9	-	-	-	-	-	1/2 tw	1	3	5	7	9	2	-	0,9	1,5	2,3	-	4	-	1,7	-	-	-	6	-	-	-	-	-	1/2 ss	1	3	5	7	9	0,1	0,4	0,8	1,2	-	-	<b>BACK (GROUP 2)</b> <b>2 - 52</b> A. SOMERSAULTS <table border="1"> <tr><td>2</td><td>4</td><td>6</td><td>8</td><td>10</td></tr> <tr><td>2,3</td><td>2,6</td><td>3,4</td><td>4,7</td><td>-</td></tr> </table> B. APPROACH <table border="1"> <tr><td>2</td><td>4</td><td>6</td><td>8</td><td>10</td></tr> <tr><td>0,2</td><td>0,3</td><td>0,5</td><td>0,7</td><td>-</td></tr> </table> C. TWISTS BARANI ENTRY <table border="1"> <tr><td>1/2 tw</td><td>2</td><td>4</td><td>6</td><td>8</td><td>10</td></tr> <tr><td>2</td><td>0,1</td><td>0,2</td><td>0,3</td><td>0,4</td><td>-</td></tr> <tr><td>4</td><td>-</td><td>0,6</td><td>0,9</td><td>-</td><td>-</td></tr> <tr><td>6</td><td>-</td><td>1,2</td><td>1,7</td><td>-</td><td>-</td></tr> <tr><td>8</td><td>-</td><td>2,0</td><td>2,7</td><td>-</td><td>-</td></tr> </table> D. TWISTS BLIND ENTRY <table border="1"> <tr><td>1/2 tw</td><td>2</td><td>4</td><td>6</td><td>8</td><td>10</td></tr> <tr><td>1</td><td>0,3</td><td>0,5</td><td>0,8</td><td>1,1</td><td>-</td></tr> <tr><td>3</td><td>-</td><td>0,9</td><td>1,4</td><td>-</td><td>-</td></tr> <tr><td>5</td><td>-</td><td>1,6</td><td>2,3</td><td>-</td><td>-</td></tr> <tr><td>7</td><td>-</td><td>2,5</td><td>3,4</td><td>-</td><td>-</td></tr> </table> F. BACK ROTATION CONTROL ENTRY <table border="1"> <tr><td>1/2 ss</td><td>2</td><td>4</td><td>6</td><td>8</td><td>10</td></tr> <tr><td>0,1</td><td>0,2</td><td>0,5</td><td>0,8</td><td>-</td><td>-</td></tr> </table>		2	4	6	8	10	2,3	2,6	3,4	4,7	-	2	4	6	8	10	0,2	0,3	0,5	0,7	-	1/2 tw	2	4	6	8	10	2	0,1	0,2	0,3	0,4	-	4	-	0,6	0,9	-	-	6	-	1,2	1,7	-	-	8	-	2,0	2,7	-	-	1/2 tw	2	4	6	8	10	1	0,3	0,5	0,8	1,1	-	3	-	0,9	1,4	-	-	5	-	1,6	2,3	-	-	7	-	2,5	3,4	-	-	1/2 ss	2	4	6	8	10	0,1	0,2	0,5	0,8	-	-	<b>REVERSE (GROUP 3)</b> <b>3 - 53</b> A. SOMERSAULTS <table border="1"> <tr><td>2</td><td>4</td><td>6</td><td>8</td><td>10</td></tr> <tr><td>2,3</td><td>2,6</td><td>3,4</td><td>4,7</td><td>-</td></tr> </table> B. APPROACH <table border="1"> <tr><td>2</td><td>4</td><td>6</td><td>8</td><td>10</td></tr> <tr><td>0,2</td><td>0,3</td><td>0,5</td><td>0,7</td><td>-</td></tr> </table> C. TWISTS BARANI ENTRY <table border="1"> <tr><td>1/2 tw</td><td>2</td><td>4</td><td>6</td><td>8</td><td>10</td></tr> <tr><td>2</td><td>0,2</td><td>0,3</td><td>0,4</td><td>0,6</td><td>-</td></tr> <tr><td>4</td><td>-</td><td>0,7</td><td>1,1</td><td>-</td><td>-</td></tr> <tr><td>6</td><td>-</td><td>1,4</td><td>-</td><td>-</td><td>-</td></tr> <tr><td>8</td><td>-</td><td>2,4</td><td>-</td><td>-</td><td>-</td></tr> </table> D. TWISTS BLIND ENTRY <table border="1"> <tr><td>1/2 tw</td><td>2</td><td>4</td><td>6</td><td>8</td><td>10</td></tr> <tr><td>1</td><td>0,4</td><td>0,6</td><td>0,9</td><td>1,3</td><td>-</td></tr> <tr><td>3</td><td>-</td><td>1,0</td><td>1,6</td><td>-</td><td>-</td></tr> <tr><td>5</td><td>-</td><td>1,8</td><td>2,4</td><td>-</td><td>-</td></tr> <tr><td>7</td><td>-</td><td>2,9</td><td>-</td><td>-</td><td>-</td></tr> </table> F. BACK ROTATION CONTROL ENTRY <table border="1"> <tr><td>1/2 ss</td><td>2</td><td>4</td><td>6</td><td>8</td><td>10</td></tr> <tr><td>0,2</td><td>0,4</td><td>0,6</td><td>1,0</td><td>-</td><td>-</td></tr> </table>		2	4	6	8	10	2,3	2,6	3,4	4,7	-	2	4	6	8	10	0,2	0,3	0,5	0,7	-	1/2 tw	2	4	6	8	10	2	0,2	0,3	0,4	0,6	-	4	-	0,7	1,1	-	-	6	-	1,4	-	-	-	8	-	2,4	-	-	-	1/2 tw	2	4	6	8	10	1	0,4	0,6	0,9	1,3	-	3	-	1,0	1,6	-	-	5	-	1,8	2,4	-	-	7	-	2,9	-	-	-	1/2 ss	2	4	6	8	10	0,2	0,4	0,6	1,0	-	-	<b>REVERSE (GROUP 5)</b> <b>6 - 63</b> A1. SOMERSAULTS <table border="1"> <tr><td>1</td><td>3</td><td>5</td><td>7</td><td>9</td></tr> <tr><td>2,3</td><td>2,6</td><td>3,4</td><td>4,7</td><td>-</td></tr> </table> B1. APPROACH <table border="1"> <tr><td>1</td><td>3</td><td>5</td><td>7</td><td>9</td></tr> <tr><td>0,1</td><td>0,3</td><td>0,5</td><td>0,8</td><td>-</td></tr> </table> F1. BACK ROTATION CONTROL ENTRY <table border="1"> <tr><td>1/2 ss</td><td>1</td><td>3</td><td>5</td><td>7</td><td>9</td></tr> <tr><td>0,2</td><td>0,4</td><td>0,6</td><td>0,8</td><td>-</td><td>-</td></tr> </table>		1	3	5	7	9	2,3	2,6	3,4	4,7	-	1	3	5	7	9	0,1	0,3	0,5	0,8	-	1/2 ss	1	3	5	7	9	0,2	0,4	0,6	0,8	-	-
2	4	6	8	10																																																																																																																																																																																																																																																																																																																																																																																																																																																																																																																			
2,3	2,6	3,4	4,7	-																																																																																																																																																																																																																																																																																																																																																																																																																																																																																																																			
2	4	6	8	10																																																																																																																																																																																																																																																																																																																																																																																																																																																																																																																			
0,0	0,0	0,0	0,0	-																																																																																																																																																																																																																																																																																																																																																																																																																																																																																																																			
1/2 tw	2	4	6	8	10																																																																																																																																																																																																																																																																																																																																																																																																																																																																																																																		
1	0,0	0,2	0,4	0,6	-																																																																																																																																																																																																																																																																																																																																																																																																																																																																																																																		
3	-	0,5	0,9	1,5	-																																																																																																																																																																																																																																																																																																																																																																																																																																																																																																																		
5	-	1,0	1,6	-	-																																																																																																																																																																																																																																																																																																																																																																																																																																																																																																																		
7	-	1,7	-	-	-																																																																																																																																																																																																																																																																																																																																																																																																																																																																																																																		
9	-	2,5	-	-	-																																																																																																																																																																																																																																																																																																																																																																																																																																																																																																																		
1/2 tw	2	4	6	8	10																																																																																																																																																																																																																																																																																																																																																																																																																																																																																																																		
2	-	0,8	1,3	2,1	-																																																																																																																																																																																																																																																																																																																																																																																																																																																																																																																		
4	-	1,4	2,1	-	-																																																																																																																																																																																																																																																																																																																																																																																																																																																																																																																		
6	-	2,2	-	-	-																																																																																																																																																																																																																																																																																																																																																																																																																																																																																																																		
1/2 ss	2	4	6	8	10																																																																																																																																																																																																																																																																																																																																																																																																																																																																																																																		
0,2	0,5	0,8	1,2	-	-																																																																																																																																																																																																																																																																																																																																																																																																																																																																																																																		
2	4	6	8	10																																																																																																																																																																																																																																																																																																																																																																																																																																																																																																																			
2,3	2,6	3,4	4,7	-																																																																																																																																																																																																																																																																																																																																																																																																																																																																																																																			
2	4	6	8	10																																																																																																																																																																																																																																																																																																																																																																																																																																																																																																																			
0,2	0,4	0,6	0,8	-																																																																																																																																																																																																																																																																																																																																																																																																																																																																																																																			
1/2 tw	2	4	6	8	10																																																																																																																																																																																																																																																																																																																																																																																																																																																																																																																		
1	0,1	0,2	0,4	0,7	-																																																																																																																																																																																																																																																																																																																																																																																																																																																																																																																		
3	-	0,6	1,0	1,6	-																																																																																																																																																																																																																																																																																																																																																																																																																																																																																																																		
5	-	1,2	1,8	-	-																																																																																																																																																																																																																																																																																																																																																																																																																																																																																																																		
7	-	2,0	-	-	-																																																																																																																																																																																																																																																																																																																																																																																																																																																																																																																		
9	-	-	-	-	-																																																																																																																																																																																																																																																																																																																																																																																																																																																																																																																		
1/2 tw	2	4	6	8	10																																																																																																																																																																																																																																																																																																																																																																																																																																																																																																																		
2	-	1,0	1,5	2,3	-																																																																																																																																																																																																																																																																																																																																																																																																																																																																																																																		
4	-	1,7	2,4	-	-																																																																																																																																																																																																																																																																																																																																																																																																																																																																																																																		
6	-	2,5	-	-	-																																																																																																																																																																																																																																																																																																																																																																																																																																																																																																																		
1/2 ss	2	4	6	8	10																																																																																																																																																																																																																																																																																																																																																																																																																																																																																																																		
0,4	0,6	0,9	1,4	-	-																																																																																																																																																																																																																																																																																																																																																																																																																																																																																																																		
1	3	5	7	9																																																																																																																																																																																																																																																																																																																																																																																																																																																																																																																			
2,3	2,6	3,4	4,7	-																																																																																																																																																																																																																																																																																																																																																																																																																																																																																																																			
1	3	5	7	9																																																																																																																																																																																																																																																																																																																																																																																																																																																																																																																			
0,0	0,1	0,3	0,5	-																																																																																																																																																																																																																																																																																																																																																																																																																																																																																																																			
1/2 tw	1	3	5	7	9																																																																																																																																																																																																																																																																																																																																																																																																																																																																																																																		
1	0,0	0,1	0,3	0,5	-																																																																																																																																																																																																																																																																																																																																																																																																																																																																																																																		
3	-	0,6	1,0	1,6	-																																																																																																																																																																																																																																																																																																																																																																																																																																																																																																																		
5	-	1,3	-	-	-																																																																																																																																																																																																																																																																																																																																																																																																																																																																																																																		
7	-	-	-	-	-																																																																																																																																																																																																																																																																																																																																																																																																																																																																																																																		
9	-	-	-	-	-																																																																																																																																																																																																																																																																																																																																																																																																																																																																																																																		
1/2 tw	1	3	5	7	9																																																																																																																																																																																																																																																																																																																																																																																																																																																																																																																		
2	-	0,9	1,5	2,3	-																																																																																																																																																																																																																																																																																																																																																																																																																																																																																																																		
4	-	1,7	-	-	-																																																																																																																																																																																																																																																																																																																																																																																																																																																																																																																		
6	-	-	-	-	-																																																																																																																																																																																																																																																																																																																																																																																																																																																																																																																		
1/2 ss	1	3	5	7	9																																																																																																																																																																																																																																																																																																																																																																																																																																																																																																																		
0,1	0,4	0,8	1,2	-	-																																																																																																																																																																																																																																																																																																																																																																																																																																																																																																																		
2	4	6	8	10																																																																																																																																																																																																																																																																																																																																																																																																																																																																																																																			
2,3	2,6	3,4	4,7	-																																																																																																																																																																																																																																																																																																																																																																																																																																																																																																																			
2	4	6	8	10																																																																																																																																																																																																																																																																																																																																																																																																																																																																																																																			
0,2	0,3	0,5	0,7	-																																																																																																																																																																																																																																																																																																																																																																																																																																																																																																																			
1/2 tw	2	4	6	8	10																																																																																																																																																																																																																																																																																																																																																																																																																																																																																																																		
2	0,1	0,2	0,3	0,4	-																																																																																																																																																																																																																																																																																																																																																																																																																																																																																																																		
4	-	0,6	0,9	-	-																																																																																																																																																																																																																																																																																																																																																																																																																																																																																																																		
6	-	1,2	1,7	-	-																																																																																																																																																																																																																																																																																																																																																																																																																																																																																																																		
8	-	2,0	2,7	-	-																																																																																																																																																																																																																																																																																																																																																																																																																																																																																																																		
1/2 tw	2	4	6	8	10																																																																																																																																																																																																																																																																																																																																																																																																																																																																																																																		
1	0,3	0,5	0,8	1,1	-																																																																																																																																																																																																																																																																																																																																																																																																																																																																																																																		
3	-	0,9	1,4	-	-																																																																																																																																																																																																																																																																																																																																																																																																																																																																																																																		
5	-	1,6	2,3	-	-																																																																																																																																																																																																																																																																																																																																																																																																																																																																																																																		
7	-	2,5	3,4	-	-																																																																																																																																																																																																																																																																																																																																																																																																																																																																																																																		
1/2 ss	2	4	6	8	10																																																																																																																																																																																																																																																																																																																																																																																																																																																																																																																		
0,1	0,2	0,5	0,8	-	-																																																																																																																																																																																																																																																																																																																																																																																																																																																																																																																		
2	4	6	8	10																																																																																																																																																																																																																																																																																																																																																																																																																																																																																																																			
2,3	2,6	3,4	4,7	-																																																																																																																																																																																																																																																																																																																																																																																																																																																																																																																			
2	4	6	8	10																																																																																																																																																																																																																																																																																																																																																																																																																																																																																																																			
0,2	0,3	0,5	0,7	-																																																																																																																																																																																																																																																																																																																																																																																																																																																																																																																			
1/2 tw	2	4	6	8	10																																																																																																																																																																																																																																																																																																																																																																																																																																																																																																																		
2	0,2	0,3	0,4	0,6	-																																																																																																																																																																																																																																																																																																																																																																																																																																																																																																																		
4	-	0,7	1,1	-	-																																																																																																																																																																																																																																																																																																																																																																																																																																																																																																																		
6	-	1,4	-	-	-																																																																																																																																																																																																																																																																																																																																																																																																																																																																																																																		
8	-	2,4	-	-	-																																																																																																																																																																																																																																																																																																																																																																																																																																																																																																																		
1/2 tw	2	4	6	8	10																																																																																																																																																																																																																																																																																																																																																																																																																																																																																																																		
1	0,4	0,6	0,9	1,3	-																																																																																																																																																																																																																																																																																																																																																																																																																																																																																																																		
3	-	1,0	1,6	-	-																																																																																																																																																																																																																																																																																																																																																																																																																																																																																																																		
5	-	1,8	2,4	-	-																																																																																																																																																																																																																																																																																																																																																																																																																																																																																																																		
7	-	2,9	-	-	-																																																																																																																																																																																																																																																																																																																																																																																																																																																																																																																		
1/2 ss	2	4	6	8	10																																																																																																																																																																																																																																																																																																																																																																																																																																																																																																																		
0,2	0,4	0,6	1,0	-	-																																																																																																																																																																																																																																																																																																																																																																																																																																																																																																																		
1	3	5	7	9																																																																																																																																																																																																																																																																																																																																																																																																																																																																																																																			
2,3	2,6	3,4	4,7	-																																																																																																																																																																																																																																																																																																																																																																																																																																																																																																																			
1	3	5	7	9																																																																																																																																																																																																																																																																																																																																																																																																																																																																																																																			
0,1	0,3	0,5	0,8	-																																																																																																																																																																																																																																																																																																																																																																																																																																																																																																																			
1/2 ss	1	3	5	7	9																																																																																																																																																																																																																																																																																																																																																																																																																																																																																																																		
0,2	0,4	0,6	0,8	-	-																																																																																																																																																																																																																																																																																																																																																																																																																																																																																																																		

**POSITIONS VALUES FOR ALL GROUPS**

STAND. 1/2 ss	2	4	6	8	10
ARM. 1/2 ss	1	3	5	7	9
A	0,2	0,2	-	-	-
B	0,0	0,0	0,0	0,0	0,0
B Flying	0,1	0,1	0,2	0,4	-
B Mid-tum	-	-	0,1	0,3	0,5
C	-0,1	-0,2	-0,2	-0,3	-0,5
C Flying	0,0	-0,1	-0,1	-0,2	-
C Mid-tum	-	-	0,0	0,0	0,2
D	0,0	0,0	0,0	0,0	0,0
E	0,1	0,1	0,2	0,4	-





# HIGH DIVING: 15 METERS

STANDING DIVES		ARMSTAND DIVES																																																																																																																																																																																																																																																																																																																																																																																																																																																																																																																																													
A+B+C+D+E+H+DD		A+H+B+C+D+H+E+H+DD																																																																																																																																																																																																																																																																																																																																																																																																																																																																																																																																													
<p><b>FORWARD (GROUP 1)</b></p> <p><b>1 - 51</b></p> <p>A. SOMERSAULTS</p> <table border="1"> <tr><td>1/2 SS</td><td>2</td><td>4</td><td>6</td><td>8</td><td>10</td></tr> <tr><td>1/2 SS</td><td>2.4</td><td>2.7</td><td>3.2</td><td>4.2</td><td>5.7</td></tr> </table> <p>B. APPROACH</p> <table border="1"> <tr><td>1/2 SS</td><td>2</td><td>4</td><td>6</td><td>8</td><td>10</td></tr> <tr><td>1/2 SS</td><td>0.0</td><td>0.0</td><td>0.0</td><td>0.0</td><td>0.0</td></tr> </table> <p>C. TWISTS BARANI ENTRY</p> <table border="1"> <tr><td>1/2 SS</td><td>2</td><td>4</td><td>6</td><td>8</td><td>10</td></tr> <tr><td>1/2 TW</td><td>1</td><td>0.0</td><td>0.2</td><td>0.4</td><td>0.7</td></tr> <tr><td>1/2 TW</td><td>3</td><td>-</td><td>0.5</td><td>0.9</td><td>1.4</td></tr> <tr><td>1/2 TW</td><td>5</td><td>-</td><td>0.9</td><td>1.5</td><td>-</td></tr> <tr><td>1/2 TW</td><td>7</td><td>-</td><td>1.4</td><td>-</td><td>-</td></tr> <tr><td>1/2 TW</td><td>9</td><td>-</td><td>2.0</td><td>-</td><td>-</td></tr> </table> <p>D. TWISTS BLIND ENTRY</p> <table border="1"> <tr><td>1/2 SS</td><td>2</td><td>4</td><td>6</td><td>8</td><td>10</td></tr> <tr><td>1/2 TW</td><td>2</td><td>-</td><td>0.8</td><td>1.3</td><td>2.0</td></tr> <tr><td>1/2 TW</td><td>4</td><td>-</td><td>1.3</td><td>2.0</td><td>-</td></tr> <tr><td>1/2 TW</td><td>6</td><td>-</td><td>1.9</td><td>-</td><td>-</td></tr> </table> <p>E. BLIND ENTRY</p> <table border="1"> <tr><td>1/2 SS</td><td>2</td><td>4</td><td>6</td><td>8</td><td>10</td></tr> <tr><td>1/2 TW</td><td>0.2</td><td>0.5</td><td>0.8</td><td>1.2</td><td>1.7</td></tr> </table>		1/2 SS	2	4	6	8	10	1/2 SS	2.4	2.7	3.2	4.2	5.7	1/2 SS	2	4	6	8	10	1/2 SS	0.0	0.0	0.0	0.0	0.0	1/2 SS	2	4	6	8	10	1/2 TW	1	0.0	0.2	0.4	0.7	1/2 TW	3	-	0.5	0.9	1.4	1/2 TW	5	-	0.9	1.5	-	1/2 TW	7	-	1.4	-	-	1/2 TW	9	-	2.0	-	-	1/2 SS	2	4	6	8	10	1/2 TW	2	-	0.8	1.3	2.0	1/2 TW	4	-	1.3	2.0	-	1/2 TW	6	-	1.9	-	-	1/2 SS	2	4	6	8	10	1/2 TW	0.2	0.5	0.8	1.2	1.7	<p><b>FORWARD (GROUP 4)</b></p> <p><b>4 - 54</b></p> <p>A. SOMERSAULTS</p> <table border="1"> <tr><td>1/2 SS</td><td>2</td><td>4</td><td>6</td><td>8</td><td>10</td></tr> <tr><td>1/2 SS</td><td>2.4</td><td>2.7</td><td>3.2</td><td>4.2</td><td>5.7</td></tr> </table> <p>B. APPROACH</p> <table border="1"> <tr><td>1/2 SS</td><td>2</td><td>4</td><td>6</td><td>8</td><td>10</td></tr> <tr><td>1/2 SS</td><td>0.2</td><td>0.4</td><td>0.6</td><td>0.8</td><td>1.0</td></tr> </table> <p>C. TWISTS BARANI ENTRY</p> <table border="1"> <tr><td>1/2 SS</td><td>2</td><td>4</td><td>6</td><td>8</td><td>10</td></tr> <tr><td>1/2 TW</td><td>1</td><td>0.1</td><td>0.2</td><td>0.4</td><td>0.7</td></tr> <tr><td>1/2 TW</td><td>3</td><td>-</td><td>0.6</td><td>1.0</td><td>1.5</td></tr> <tr><td>1/2 TW</td><td>5</td><td>-</td><td>1.1</td><td>1.7</td><td>-</td></tr> <tr><td>1/2 TW</td><td>7</td><td>-</td><td>1.7</td><td>-</td><td>-</td></tr> </table> <p>D. TWISTS BLIND ENTRY</p> <table border="1"> <tr><td>1/2 SS</td><td>2</td><td>4</td><td>6</td><td>8</td><td>10</td></tr> <tr><td>1/2 TW</td><td>2</td><td>-</td><td>1.0</td><td>1.5</td><td>2.2</td></tr> <tr><td>1/2 TW</td><td>4</td><td>-</td><td>1.6</td><td>2.3</td><td>-</td></tr> <tr><td>1/2 TW</td><td>6</td><td>-</td><td>2.3</td><td>-</td><td>-</td></tr> </table> <p>E. BLIND ENTRY</p> <table border="1"> <tr><td>1/2 SS</td><td>2</td><td>4</td><td>6</td><td>8</td><td>10</td></tr> <tr><td>1/2 TW</td><td>0.4</td><td>0.6</td><td>0.9</td><td>1.4</td><td>2.0</td></tr> </table>		1/2 SS	2	4	6	8	10	1/2 SS	2.4	2.7	3.2	4.2	5.7	1/2 SS	2	4	6	8	10	1/2 SS	0.2	0.4	0.6	0.8	1.0	1/2 SS	2	4	6	8	10	1/2 TW	1	0.1	0.2	0.4	0.7	1/2 TW	3	-	0.6	1.0	1.5	1/2 TW	5	-	1.1	1.7	-	1/2 TW	7	-	1.7	-	-	1/2 SS	2	4	6	8	10	1/2 TW	2	-	1.0	1.5	2.2	1/2 TW	4	-	1.6	2.3	-	1/2 TW	6	-	2.3	-	-	1/2 SS	2	4	6	8	10	1/2 TW	0.4	0.6	0.9	1.4	2.0	<p><b>FORWARD (GROUP 5)</b></p> <p><b>6 - 61</b></p> <p>A. SOMERSAULTS</p> <table border="1"> <tr><td>1/2 SS</td><td>1</td><td>3</td><td>5</td><td>7</td><td>9</td></tr> <tr><td>1/2 SS</td><td>2.4</td><td>2.7</td><td>3.2</td><td>4.2</td><td>5.7</td></tr> </table> <p>B. APPROACH</p> <table border="1"> <tr><td>1/2 SS</td><td>1</td><td>3</td><td>5</td><td>7</td><td>9</td></tr> <tr><td>1/2 SS</td><td>0.0</td><td>0.1</td><td>0.3</td><td>0.5</td><td>0.7</td></tr> </table> <p>C. TWISTS BARANI ENTRY</p> <table border="1"> <tr><td>1/2 SS</td><td>1</td><td>3</td><td>5</td><td>7</td><td>9</td></tr> <tr><td>1/2 TW</td><td>1</td><td>0.0</td><td>0.1</td><td>0.3</td><td>0.5</td></tr> <tr><td>1/2 TW</td><td>3</td><td>-</td><td>0.6</td><td>0.9</td><td>1.4</td></tr> <tr><td>1/2 TW</td><td>5</td><td>-</td><td>1.2</td><td>-</td><td>-</td></tr> <tr><td>1/2 TW</td><td>7</td><td>-</td><td>-</td><td>-</td><td>-</td></tr> </table> <p>D. TWISTS BLIND ENTRY</p> <table border="1"> <tr><td>1/2 SS</td><td>1</td><td>3</td><td>5</td><td>7</td><td>9</td></tr> <tr><td>1/2 TW</td><td>1</td><td>-</td><td>0.9</td><td>1.4</td><td>2.1</td></tr> <tr><td>1/2 TW</td><td>3</td><td>-</td><td>1.6</td><td>-</td><td>-</td></tr> <tr><td>1/2 TW</td><td>5</td><td>-</td><td>-</td><td>-</td><td>-</td></tr> </table> <p>E. BLIND ENTRY</p> <table border="1"> <tr><td>1/2 SS</td><td>1</td><td>3</td><td>5</td><td>7</td><td>9</td></tr> <tr><td>1/2 TW</td><td>0.1</td><td>0.4</td><td>0.8</td><td>1.2</td><td>1.6</td></tr> </table>		1/2 SS	1	3	5	7	9	1/2 SS	2.4	2.7	3.2	4.2	5.7	1/2 SS	1	3	5	7	9	1/2 SS	0.0	0.1	0.3	0.5	0.7	1/2 SS	1	3	5	7	9	1/2 TW	1	0.0	0.1	0.3	0.5	1/2 TW	3	-	0.6	0.9	1.4	1/2 TW	5	-	1.2	-	-	1/2 TW	7	-	-	-	-	1/2 SS	1	3	5	7	9	1/2 TW	1	-	0.9	1.4	2.1	1/2 TW	3	-	1.6	-	-	1/2 TW	5	-	-	-	-	1/2 SS	1	3	5	7	9	1/2 TW	0.1	0.4	0.8	1.2	1.6	<p><b>BACK (GROUP 2)</b></p> <p><b>2 - 52</b></p> <p>A. SOMERSAULTS</p> <table border="1"> <tr><td>1/2 SS</td><td>2</td><td>4</td><td>6</td><td>8</td><td>10</td></tr> <tr><td>1/2 SS</td><td>2.4</td><td>2.7</td><td>3.2</td><td>4.2</td><td>5.7</td></tr> </table> <p>B. APPROACH</p> <table border="1"> <tr><td>1/2 SS</td><td>2</td><td>4</td><td>6</td><td>8</td><td>10</td></tr> <tr><td>1/2 SS</td><td>0.2</td><td>0.3</td><td>0.5</td><td>0.7</td><td>0.9</td></tr> </table> <p>C. TWISTS BARANI ENTRY</p> <table border="1"> <tr><td>1/2 SS</td><td>2</td><td>4</td><td>6</td><td>8</td><td>10</td></tr> <tr><td>1/2 TW</td><td>2</td><td>0.1</td><td>0.2</td><td>0.3</td><td>0.4</td></tr> <tr><td>1/2 TW</td><td>4</td><td>-</td><td>0.5</td><td>0.8</td><td>-</td></tr> <tr><td>1/2 TW</td><td>6</td><td>-</td><td>0.9</td><td>1.4</td><td>-</td></tr> <tr><td>1/2 TW</td><td>8</td><td>-</td><td>1.5</td><td>2.1</td><td>-</td></tr> <tr><td>1/2 TW</td><td>10</td><td>-</td><td>-</td><td>-</td><td>-</td></tr> </table> <p>D. TWISTS BLIND ENTRY</p> <table border="1"> <tr><td>1/2 SS</td><td>2</td><td>4</td><td>6</td><td>8</td><td>10</td></tr> <tr><td>1/2 TW</td><td>1</td><td>0.3</td><td>0.5</td><td>0.8</td><td>1.1</td></tr> <tr><td>1/2 TW</td><td>3</td><td>-</td><td>0.8</td><td>1.3</td><td>-</td></tr> <tr><td>1/2 TW</td><td>5</td><td>-</td><td>1.3</td><td>2.0</td><td>-</td></tr> <tr><td>1/2 TW</td><td>7</td><td>-</td><td>2.0</td><td>2.8</td><td>-</td></tr> </table> <p>F. BACK ROTATION CONTROL ENTRY</p> <table border="1"> <tr><td>1/2 SS</td><td>2</td><td>4</td><td>6</td><td>8</td><td>10</td></tr> <tr><td>1/2 TW</td><td>0.1</td><td>0.2</td><td>0.3</td><td>0.5</td><td>0.8</td></tr> </table>		1/2 SS	2	4	6	8	10	1/2 SS	2.4	2.7	3.2	4.2	5.7	1/2 SS	2	4	6	8	10	1/2 SS	0.2	0.3	0.5	0.7	0.9	1/2 SS	2	4	6	8	10	1/2 TW	2	0.1	0.2	0.3	0.4	1/2 TW	4	-	0.5	0.8	-	1/2 TW	6	-	0.9	1.4	-	1/2 TW	8	-	1.5	2.1	-	1/2 TW	10	-	-	-	-	1/2 SS	2	4	6	8	10	1/2 TW	1	0.3	0.5	0.8	1.1	1/2 TW	3	-	0.8	1.3	-	1/2 TW	5	-	1.3	2.0	-	1/2 TW	7	-	2.0	2.8	-	1/2 SS	2	4	6	8	10	1/2 TW	0.1	0.2	0.3	0.5	0.8	<p><b>BACK (GROUP 3)</b></p> <p><b>3 - 53</b></p> <p>A. SOMERSAULTS</p> <table border="1"> <tr><td>1/2 SS</td><td>2</td><td>4</td><td>6</td><td>8</td><td>10</td></tr> <tr><td>1/2 SS</td><td>2.4</td><td>2.7</td><td>3.2</td><td>4.2</td><td>5.7</td></tr> </table> <p>B. APPROACH</p> <table border="1"> <tr><td>1/2 SS</td><td>2</td><td>4</td><td>6</td><td>8</td><td>10</td></tr> <tr><td>1/2 SS</td><td>0.2</td><td>0.3</td><td>0.5</td><td>0.7</td><td>0.9</td></tr> </table> <p>C. TWISTS BARANI ENTRY</p> <table border="1"> <tr><td>1/2 SS</td><td>2</td><td>4</td><td>6</td><td>8</td><td>10</td></tr> <tr><td>1/2 TW</td><td>2</td><td>0.2</td><td>0.3</td><td>0.4</td><td>0.6</td></tr> <tr><td>1/2 TW</td><td>4</td><td>-</td><td>0.7</td><td>1.1</td><td>-</td></tr> <tr><td>1/2 TW</td><td>6</td><td>-</td><td>1.2</td><td>-</td><td>-</td></tr> <tr><td>1/2 TW</td><td>8</td><td>-</td><td>1.8</td><td>-</td><td>-</td></tr> <tr><td>1/2 TW</td><td>10</td><td>-</td><td>-</td><td>-</td><td>-</td></tr> </table> <p>D. TWISTS BLIND ENTRY</p> <table border="1"> <tr><td>1/2 SS</td><td>2</td><td>4</td><td>6</td><td>8</td><td>10</td></tr> <tr><td>1/2 TW</td><td>1</td><td>0.4</td><td>0.6</td><td>0.9</td><td>1.3</td></tr> <tr><td>1/2 TW</td><td>3</td><td>-</td><td>1.0</td><td>1.6</td><td>-</td></tr> <tr><td>1/2 TW</td><td>5</td><td>-</td><td>1.6</td><td>-</td><td>-</td></tr> <tr><td>1/2 TW</td><td>7</td><td>-</td><td>2.3</td><td>-</td><td>-</td></tr> </table> <p>F. BACK ROTATION CONTROL ENTRY</p> <table border="1"> <tr><td>1/2 SS</td><td>2</td><td>4</td><td>6</td><td>8</td><td>10</td></tr> <tr><td>1/2 TW</td><td>0.1</td><td>0.3</td><td>0.5</td><td>0.8</td><td>1.1</td></tr> </table>		1/2 SS	2	4	6	8	10	1/2 SS	2.4	2.7	3.2	4.2	5.7	1/2 SS	2	4	6	8	10	1/2 SS	0.2	0.3	0.5	0.7	0.9	1/2 SS	2	4	6	8	10	1/2 TW	2	0.2	0.3	0.4	0.6	1/2 TW	4	-	0.7	1.1	-	1/2 TW	6	-	1.2	-	-	1/2 TW	8	-	1.8	-	-	1/2 TW	10	-	-	-	-	1/2 SS	2	4	6	8	10	1/2 TW	1	0.4	0.6	0.9	1.3	1/2 TW	3	-	1.0	1.6	-	1/2 TW	5	-	1.6	-	-	1/2 TW	7	-	2.3	-	-	1/2 SS	2	4	6	8	10	1/2 TW	0.1	0.3	0.5	0.8	1.1	<p><b>BACK (GROUP 5)</b></p> <p><b>6 - 63</b></p> <p>A. SOMERSAULTS</p> <table border="1"> <tr><td>1/2 SS</td><td>1</td><td>3</td><td>5</td><td>7</td><td>9</td></tr> <tr><td>1/2 SS</td><td>2.4</td><td>2.7</td><td>3.2</td><td>4.2</td><td>5.7</td></tr> </table> <p>B. SOMERSAULTS</p> <table border="1"> <tr><td>1/2 SS</td><td>1</td><td>3</td><td>5</td><td>7</td><td>9</td></tr> <tr><td>1/2 TW</td><td>0.1</td><td>0.3</td><td>0.5</td><td>0.8</td><td>1.1</td></tr> </table> <p>F. BACK ROTATION CONTROL ENTRY</p> <table border="1"> <tr><td>1/2 SS</td><td>1</td><td>3</td><td>5</td><td>7</td><td>9</td></tr> <tr><td>1/2 TW</td><td>0.2</td><td>0.4</td><td>0.6</td><td>0.8</td><td>1.0</td></tr> </table>		1/2 SS	1	3	5	7	9	1/2 SS	2.4	2.7	3.2	4.2	5.7	1/2 SS	1	3	5	7	9	1/2 TW	0.1	0.3	0.5	0.8	1.1	1/2 SS	1	3	5	7	9	1/2 TW	0.2	0.4	0.6	0.8	1.0
1/2 SS	2	4	6	8	10																																																																																																																																																																																																																																																																																																																																																																																																																																																																																																																																										
1/2 SS	2.4	2.7	3.2	4.2	5.7																																																																																																																																																																																																																																																																																																																																																																																																																																																																																																																																										
1/2 SS	2	4	6	8	10																																																																																																																																																																																																																																																																																																																																																																																																																																																																																																																																										
1/2 SS	0.0	0.0	0.0	0.0	0.0																																																																																																																																																																																																																																																																																																																																																																																																																																																																																																																																										
1/2 SS	2	4	6	8	10																																																																																																																																																																																																																																																																																																																																																																																																																																																																																																																																										
1/2 TW	1	0.0	0.2	0.4	0.7																																																																																																																																																																																																																																																																																																																																																																																																																																																																																																																																										
1/2 TW	3	-	0.5	0.9	1.4																																																																																																																																																																																																																																																																																																																																																																																																																																																																																																																																										
1/2 TW	5	-	0.9	1.5	-																																																																																																																																																																																																																																																																																																																																																																																																																																																																																																																																										
1/2 TW	7	-	1.4	-	-																																																																																																																																																																																																																																																																																																																																																																																																																																																																																																																																										
1/2 TW	9	-	2.0	-	-																																																																																																																																																																																																																																																																																																																																																																																																																																																																																																																																										
1/2 SS	2	4	6	8	10																																																																																																																																																																																																																																																																																																																																																																																																																																																																																																																																										
1/2 TW	2	-	0.8	1.3	2.0																																																																																																																																																																																																																																																																																																																																																																																																																																																																																																																																										
1/2 TW	4	-	1.3	2.0	-																																																																																																																																																																																																																																																																																																																																																																																																																																																																																																																																										
1/2 TW	6	-	1.9	-	-																																																																																																																																																																																																																																																																																																																																																																																																																																																																																																																																										
1/2 SS	2	4	6	8	10																																																																																																																																																																																																																																																																																																																																																																																																																																																																																																																																										
1/2 TW	0.2	0.5	0.8	1.2	1.7																																																																																																																																																																																																																																																																																																																																																																																																																																																																																																																																										
1/2 SS	2	4	6	8	10																																																																																																																																																																																																																																																																																																																																																																																																																																																																																																																																										
1/2 SS	2.4	2.7	3.2	4.2	5.7																																																																																																																																																																																																																																																																																																																																																																																																																																																																																																																																										
1/2 SS	2	4	6	8	10																																																																																																																																																																																																																																																																																																																																																																																																																																																																																																																																										
1/2 SS	0.2	0.4	0.6	0.8	1.0																																																																																																																																																																																																																																																																																																																																																																																																																																																																																																																																										
1/2 SS	2	4	6	8	10																																																																																																																																																																																																																																																																																																																																																																																																																																																																																																																																										
1/2 TW	1	0.1	0.2	0.4	0.7																																																																																																																																																																																																																																																																																																																																																																																																																																																																																																																																										
1/2 TW	3	-	0.6	1.0	1.5																																																																																																																																																																																																																																																																																																																																																																																																																																																																																																																																										
1/2 TW	5	-	1.1	1.7	-																																																																																																																																																																																																																																																																																																																																																																																																																																																																																																																																										
1/2 TW	7	-	1.7	-	-																																																																																																																																																																																																																																																																																																																																																																																																																																																																																																																																										
1/2 SS	2	4	6	8	10																																																																																																																																																																																																																																																																																																																																																																																																																																																																																																																																										
1/2 TW	2	-	1.0	1.5	2.2																																																																																																																																																																																																																																																																																																																																																																																																																																																																																																																																										
1/2 TW	4	-	1.6	2.3	-																																																																																																																																																																																																																																																																																																																																																																																																																																																																																																																																										
1/2 TW	6	-	2.3	-	-																																																																																																																																																																																																																																																																																																																																																																																																																																																																																																																																										
1/2 SS	2	4	6	8	10																																																																																																																																																																																																																																																																																																																																																																																																																																																																																																																																										
1/2 TW	0.4	0.6	0.9	1.4	2.0																																																																																																																																																																																																																																																																																																																																																																																																																																																																																																																																										
1/2 SS	1	3	5	7	9																																																																																																																																																																																																																																																																																																																																																																																																																																																																																																																																										
1/2 SS	2.4	2.7	3.2	4.2	5.7																																																																																																																																																																																																																																																																																																																																																																																																																																																																																																																																										
1/2 SS	1	3	5	7	9																																																																																																																																																																																																																																																																																																																																																																																																																																																																																																																																										
1/2 SS	0.0	0.1	0.3	0.5	0.7																																																																																																																																																																																																																																																																																																																																																																																																																																																																																																																																										
1/2 SS	1	3	5	7	9																																																																																																																																																																																																																																																																																																																																																																																																																																																																																																																																										
1/2 TW	1	0.0	0.1	0.3	0.5																																																																																																																																																																																																																																																																																																																																																																																																																																																																																																																																										
1/2 TW	3	-	0.6	0.9	1.4																																																																																																																																																																																																																																																																																																																																																																																																																																																																																																																																										
1/2 TW	5	-	1.2	-	-																																																																																																																																																																																																																																																																																																																																																																																																																																																																																																																																										
1/2 TW	7	-	-	-	-																																																																																																																																																																																																																																																																																																																																																																																																																																																																																																																																										
1/2 SS	1	3	5	7	9																																																																																																																																																																																																																																																																																																																																																																																																																																																																																																																																										
1/2 TW	1	-	0.9	1.4	2.1																																																																																																																																																																																																																																																																																																																																																																																																																																																																																																																																										
1/2 TW	3	-	1.6	-	-																																																																																																																																																																																																																																																																																																																																																																																																																																																																																																																																										
1/2 TW	5	-	-	-	-																																																																																																																																																																																																																																																																																																																																																																																																																																																																																																																																										
1/2 SS	1	3	5	7	9																																																																																																																																																																																																																																																																																																																																																																																																																																																																																																																																										
1/2 TW	0.1	0.4	0.8	1.2	1.6																																																																																																																																																																																																																																																																																																																																																																																																																																																																																																																																										
1/2 SS	2	4	6	8	10																																																																																																																																																																																																																																																																																																																																																																																																																																																																																																																																										
1/2 SS	2.4	2.7	3.2	4.2	5.7																																																																																																																																																																																																																																																																																																																																																																																																																																																																																																																																										
1/2 SS	2	4	6	8	10																																																																																																																																																																																																																																																																																																																																																																																																																																																																																																																																										
1/2 SS	0.2	0.3	0.5	0.7	0.9																																																																																																																																																																																																																																																																																																																																																																																																																																																																																																																																										
1/2 SS	2	4	6	8	10																																																																																																																																																																																																																																																																																																																																																																																																																																																																																																																																										
1/2 TW	2	0.1	0.2	0.3	0.4																																																																																																																																																																																																																																																																																																																																																																																																																																																																																																																																										
1/2 TW	4	-	0.5	0.8	-																																																																																																																																																																																																																																																																																																																																																																																																																																																																																																																																										
1/2 TW	6	-	0.9	1.4	-																																																																																																																																																																																																																																																																																																																																																																																																																																																																																																																																										
1/2 TW	8	-	1.5	2.1	-																																																																																																																																																																																																																																																																																																																																																																																																																																																																																																																																										
1/2 TW	10	-	-	-	-																																																																																																																																																																																																																																																																																																																																																																																																																																																																																																																																										
1/2 SS	2	4	6	8	10																																																																																																																																																																																																																																																																																																																																																																																																																																																																																																																																										
1/2 TW	1	0.3	0.5	0.8	1.1																																																																																																																																																																																																																																																																																																																																																																																																																																																																																																																																										
1/2 TW	3	-	0.8	1.3	-																																																																																																																																																																																																																																																																																																																																																																																																																																																																																																																																										
1/2 TW	5	-	1.3	2.0	-																																																																																																																																																																																																																																																																																																																																																																																																																																																																																																																																										
1/2 TW	7	-	2.0	2.8	-																																																																																																																																																																																																																																																																																																																																																																																																																																																																																																																																										
1/2 SS	2	4	6	8	10																																																																																																																																																																																																																																																																																																																																																																																																																																																																																																																																										
1/2 TW	0.1	0.2	0.3	0.5	0.8																																																																																																																																																																																																																																																																																																																																																																																																																																																																																																																																										
1/2 SS	2	4	6	8	10																																																																																																																																																																																																																																																																																																																																																																																																																																																																																																																																										
1/2 SS	2.4	2.7	3.2	4.2	5.7																																																																																																																																																																																																																																																																																																																																																																																																																																																																																																																																										
1/2 SS	2	4	6	8	10																																																																																																																																																																																																																																																																																																																																																																																																																																																																																																																																										
1/2 SS	0.2	0.3	0.5	0.7	0.9																																																																																																																																																																																																																																																																																																																																																																																																																																																																																																																																										
1/2 SS	2	4	6	8	10																																																																																																																																																																																																																																																																																																																																																																																																																																																																																																																																										
1/2 TW	2	0.2	0.3	0.4	0.6																																																																																																																																																																																																																																																																																																																																																																																																																																																																																																																																										
1/2 TW	4	-	0.7	1.1	-																																																																																																																																																																																																																																																																																																																																																																																																																																																																																																																																										
1/2 TW	6	-	1.2	-	-																																																																																																																																																																																																																																																																																																																																																																																																																																																																																																																																										
1/2 TW	8	-	1.8	-	-																																																																																																																																																																																																																																																																																																																																																																																																																																																																																																																																										
1/2 TW	10	-	-	-	-																																																																																																																																																																																																																																																																																																																																																																																																																																																																																																																																										
1/2 SS	2	4	6	8	10																																																																																																																																																																																																																																																																																																																																																																																																																																																																																																																																										
1/2 TW	1	0.4	0.6	0.9	1.3																																																																																																																																																																																																																																																																																																																																																																																																																																																																																																																																										
1/2 TW	3	-	1.0	1.6	-																																																																																																																																																																																																																																																																																																																																																																																																																																																																																																																																										
1/2 TW	5	-	1.6	-	-																																																																																																																																																																																																																																																																																																																																																																																																																																																																																																																																										
1/2 TW	7	-	2.3	-	-																																																																																																																																																																																																																																																																																																																																																																																																																																																																																																																																										
1/2 SS	2	4	6	8	10																																																																																																																																																																																																																																																																																																																																																																																																																																																																																																																																										
1/2 TW	0.1	0.3	0.5	0.8	1.1																																																																																																																																																																																																																																																																																																																																																																																																																																																																																																																																										
1/2 SS	1	3	5	7	9																																																																																																																																																																																																																																																																																																																																																																																																																																																																																																																																										
1/2 SS	2.4	2.7	3.2	4.2	5.7																																																																																																																																																																																																																																																																																																																																																																																																																																																																																																																																										
1/2 SS	1	3	5	7	9																																																																																																																																																																																																																																																																																																																																																																																																																																																																																																																																										
1/2 TW	0.1	0.3	0.5	0.8	1.1																																																																																																																																																																																																																																																																																																																																																																																																																																																																																																																																										
1/2 SS	1	3	5	7	9																																																																																																																																																																																																																																																																																																																																																																																																																																																																																																																																										
1/2 TW	0.2	0.4	0.6	0.8	1.0																																																																																																																																																																																																																																																																																																																																																																																																																																																																																																																																										



HIGH DIVING: 20 METRES

STANDING DIVES A+B+C+D+E+H+PO5-DD		ARMSTAND DIVES A1+B1+C1+D1+E1+F1+PO5-DD																																																																																					
FORWARD (GROUP 1)		FORWARD (GROUP 5)																																																																																					
1 - 51		6 - 61																																																																																					
<p><b>A. SOMERSAULTS</b></p> <table border="1"> <tr><th>1/2 ss</th><th>3</th><th>5</th><th>7</th><th>9</th></tr> <tr><td>2</td><td>4</td><td>6</td><td>8</td><td>10</td></tr> <tr><td>2.5</td><td>2.8</td><td>3.4</td><td>4.4</td><td>5.9</td></tr> </table>		1/2 ss	3	5	7	9	2	4	6	8	10	2.5	2.8	3.4	4.4	5.9	<p><b>A1. SOMERSAULTS</b></p> <table border="1"> <tr><th>1/2 ss</th><th>3</th><th>5</th><th>7</th><th>9</th></tr> <tr><td>1</td><td>3</td><td>5</td><td>7</td><td>9</td></tr> <tr><td>2.6</td><td>2.9</td><td>3.4</td><td>4.4</td><td>4.1</td></tr> </table>		1/2 ss	3	5	7	9	1	3	5	7	9	2.6	2.9	3.4	4.4	4.1																																																						
1/2 ss	3	5	7	9																																																																																			
2	4	6	8	10																																																																																			
2.5	2.8	3.4	4.4	5.9																																																																																			
1/2 ss	3	5	7	9																																																																																			
1	3	5	7	9																																																																																			
2.6	2.9	3.4	4.4	4.1																																																																																			
<p><b>B. APPROACH</b></p> <table border="1"> <tr><th>1/2 ss</th><th>3</th><th>5</th><th>7</th><th>9</th></tr> <tr><td>2</td><td>4</td><td>6</td><td>8</td><td>10</td></tr> <tr><td>0.0</td><td>0.0</td><td>0.0</td><td>0.0</td><td>0.0</td></tr> </table>		1/2 ss	3	5	7	9	2	4	6	8	10	0.0	0.0	0.0	0.0	0.0	<p><b>B1. APPROACH</b></p> <table border="1"> <tr><th>1/2 ss</th><th>3</th><th>5</th><th>7</th><th>9</th></tr> <tr><td>1</td><td>3</td><td>5</td><td>7</td><td>9</td></tr> <tr><td>0.1</td><td>0.3</td><td>-</td><td>-</td><td>-</td></tr> </table>		1/2 ss	3	5	7	9	1	3	5	7	9	0.1	0.3	-	-	-																																																						
1/2 ss	3	5	7	9																																																																																			
2	4	6	8	10																																																																																			
0.0	0.0	0.0	0.0	0.0																																																																																			
1/2 ss	3	5	7	9																																																																																			
1	3	5	7	9																																																																																			
0.1	0.3	-	-	-																																																																																			
<p><b>C. TWISTS BARANI ENTRY</b></p> <table border="1"> <tr><th>1/2 ss</th><th>2</th><th>4</th><th>6</th><th>8</th><th>10</th></tr> <tr><td>1</td><td>0.0</td><td>0.0</td><td>0.0</td><td>0.0</td><td>0.0</td></tr> <tr><td>3</td><td>0.2</td><td>0.4</td><td>0.6</td><td>0.8</td><td>1.0</td></tr> <tr><td>5</td><td>0.5</td><td>0.7</td><td>1.1</td><td>1.5</td><td>1.9</td></tr> <tr><td>7</td><td>0.9</td><td>1.2</td><td>1.8</td><td>2.4</td><td>3.0</td></tr> <tr><td>9</td><td>1.4</td><td>1.8</td><td>2.6</td><td>3.4</td><td>4.2</td></tr> </table>		1/2 ss	2	4	6	8	10	1	0.0	0.0	0.0	0.0	0.0	3	0.2	0.4	0.6	0.8	1.0	5	0.5	0.7	1.1	1.5	1.9	7	0.9	1.2	1.8	2.4	3.0	9	1.4	1.8	2.6	3.4	4.2	<p><b>C1. TWISTS BARANI ENTRY</b></p> <table border="1"> <tr><th>1/2 ss</th><th>2</th><th>4</th><th>6</th><th>8</th><th>10</th></tr> <tr><td>1</td><td>0.0</td><td>0.0</td><td>0.0</td><td>0.0</td><td>0.0</td></tr> <tr><td>3</td><td>0.2</td><td>0.3</td><td>0.4</td><td>0.6</td><td>0.8</td></tr> <tr><td>5</td><td>0.5</td><td>0.7</td><td>0.9</td><td>1.3</td><td>1.7</td></tr> <tr><td>7</td><td>0.9</td><td>1.2</td><td>1.5</td><td>2.1</td><td>2.7</td></tr> <tr><td>9</td><td>1.4</td><td>1.8</td><td>2.2</td><td>3.0</td><td>3.8</td></tr> </table>		1/2 ss	2	4	6	8	10	1	0.0	0.0	0.0	0.0	0.0	3	0.2	0.3	0.4	0.6	0.8	5	0.5	0.7	0.9	1.3	1.7	7	0.9	1.2	1.5	2.1	2.7	9	1.4	1.8	2.2	3.0	3.8												
1/2 ss	2	4	6	8	10																																																																																		
1	0.0	0.0	0.0	0.0	0.0																																																																																		
3	0.2	0.4	0.6	0.8	1.0																																																																																		
5	0.5	0.7	1.1	1.5	1.9																																																																																		
7	0.9	1.2	1.8	2.4	3.0																																																																																		
9	1.4	1.8	2.6	3.4	4.2																																																																																		
1/2 ss	2	4	6	8	10																																																																																		
1	0.0	0.0	0.0	0.0	0.0																																																																																		
3	0.2	0.3	0.4	0.6	0.8																																																																																		
5	0.5	0.7	0.9	1.3	1.7																																																																																		
7	0.9	1.2	1.5	2.1	2.7																																																																																		
9	1.4	1.8	2.2	3.0	3.8																																																																																		
<p><b>D. TWISTS BLIND ENTRY</b></p> <table border="1"> <tr><th>1/2 ss</th><th>2</th><th>4</th><th>6</th><th>8</th><th>10</th></tr> <tr><td>1</td><td>0.0</td><td>0.0</td><td>0.0</td><td>0.0</td><td>0.0</td></tr> <tr><td>2</td><td>0.4</td><td>0.6</td><td>0.9</td><td>1.3</td><td>1.7</td></tr> <tr><td>4</td><td>-</td><td>1.1</td><td>1.6</td><td>2.2</td><td>-</td></tr> <tr><td>6</td><td>-</td><td>1.7</td><td>2.4</td><td>3.2</td><td>-</td></tr> <tr><td>8</td><td>-</td><td>2.5</td><td>3.3</td><td>-</td><td>-</td></tr> </table>		1/2 ss	2	4	6	8	10	1	0.0	0.0	0.0	0.0	0.0	2	0.4	0.6	0.9	1.3	1.7	4	-	1.1	1.6	2.2	-	6	-	1.7	2.4	3.2	-	8	-	2.5	3.3	-	-	<p><b>D1. TWISTS BLIND ENTRY</b></p> <table border="1"> <tr><th>1/2 ss</th><th>2</th><th>4</th><th>6</th><th>8</th><th>9</th></tr> <tr><td>1</td><td>0.0</td><td>0.0</td><td>0.0</td><td>0.0</td><td>0.0</td></tr> <tr><td>2</td><td>0.6</td><td>0.9</td><td>1.3</td><td>1.7</td><td>-</td></tr> <tr><td>4</td><td>-</td><td>1.1</td><td>1.5</td><td>2.1</td><td>-</td></tr> <tr><td>6</td><td>-</td><td>-</td><td>2.2</td><td>-</td><td>-</td></tr> <tr><td>8</td><td>-</td><td>-</td><td>-</td><td>-</td><td>-</td></tr> </table>		1/2 ss	2	4	6	8	9	1	0.0	0.0	0.0	0.0	0.0	2	0.6	0.9	1.3	1.7	-	4	-	1.1	1.5	2.1	-	6	-	-	2.2	-	-	8	-	-	-	-	-												
1/2 ss	2	4	6	8	10																																																																																		
1	0.0	0.0	0.0	0.0	0.0																																																																																		
2	0.4	0.6	0.9	1.3	1.7																																																																																		
4	-	1.1	1.6	2.2	-																																																																																		
6	-	1.7	2.4	3.2	-																																																																																		
8	-	2.5	3.3	-	-																																																																																		
1/2 ss	2	4	6	8	9																																																																																		
1	0.0	0.0	0.0	0.0	0.0																																																																																		
2	0.6	0.9	1.3	1.7	-																																																																																		
4	-	1.1	1.5	2.1	-																																																																																		
6	-	-	2.2	-	-																																																																																		
8	-	-	-	-	-																																																																																		
<p><b>E. BLIND ENTRY</b></p> <table border="1"> <tr><th>1/2 ss</th><th>2</th><th>4</th><th>6</th><th>8</th><th>10</th></tr> <tr><td>2</td><td>4</td><td>6</td><td>8</td><td>10</td><td>-</td></tr> <tr><td>0.2</td><td>0.3</td><td>0.4</td><td>0.6</td><td>0.8</td><td>-</td></tr> </table>		1/2 ss	2	4	6	8	10	2	4	6	8	10	-	0.2	0.3	0.4	0.6	0.8	-	<p><b>E1. BLIND ENTRY</b></p> <table border="1"> <tr><th>1/2 ss</th><th>2</th><th>4</th><th>6</th><th>8</th><th>9</th></tr> <tr><td>1</td><td>3</td><td>5</td><td>7</td><td>9</td><td>-</td></tr> <tr><td>0.1</td><td>0.3</td><td>0.5</td><td>0.7</td><td>0.9</td><td>-</td></tr> </table>		1/2 ss	2	4	6	8	9	1	3	5	7	9	-	0.1	0.3	0.5	0.7	0.9	-																																																
1/2 ss	2	4	6	8	10																																																																																		
2	4	6	8	10	-																																																																																		
0.2	0.3	0.4	0.6	0.8	-																																																																																		
1/2 ss	2	4	6	8	9																																																																																		
1	3	5	7	9	-																																																																																		
0.1	0.3	0.5	0.7	0.9	-																																																																																		
FORWARD (GROUP 5)		BACK (GROUP 5)																																																																																					
4 - 54		6 - 63																																																																																					
<p><b>A. SOMERSAULTS</b></p> <table border="1"> <tr><th>1/2 ss</th><th>2</th><th>4</th><th>6</th><th>8</th><th>10</th></tr> <tr><td>2</td><td>4</td><td>6</td><td>8</td><td>10</td><td>-</td></tr> <tr><td>2.5</td><td>2.8</td><td>3.4</td><td>4.4</td><td>5.9</td><td>-</td></tr> </table>		1/2 ss	2	4	6	8	10	2	4	6	8	10	-	2.5	2.8	3.4	4.4	5.9	-	<p><b>A1. SOMERSAULTS</b></p> <table border="1"> <tr><th>1/2 ss</th><th>2</th><th>4</th><th>6</th><th>8</th><th>10</th></tr> <tr><td>1</td><td>3</td><td>5</td><td>7</td><td>9</td><td>-</td></tr> <tr><td>2.5</td><td>2.8</td><td>3.4</td><td>4.4</td><td>5.9</td><td>-</td></tr> </table>		1/2 ss	2	4	6	8	10	1	3	5	7	9	-	2.5	2.8	3.4	4.4	5.9	-																																																
1/2 ss	2	4	6	8	10																																																																																		
2	4	6	8	10	-																																																																																		
2.5	2.8	3.4	4.4	5.9	-																																																																																		
1/2 ss	2	4	6	8	10																																																																																		
1	3	5	7	9	-																																																																																		
2.5	2.8	3.4	4.4	5.9	-																																																																																		
<p><b>B. APPROACH</b></p> <table border="1"> <tr><th>1/2 ss</th><th>2</th><th>4</th><th>6</th><th>8</th><th>10</th></tr> <tr><td>2</td><td>4</td><td>6</td><td>8</td><td>10</td><td>-</td></tr> <tr><td>0.2</td><td>0.4</td><td>0.6</td><td>0.8</td><td>1.0</td><td>-</td></tr> </table>		1/2 ss	2	4	6	8	10	2	4	6	8	10	-	0.2	0.4	0.6	0.8	1.0	-	<p><b>B1. APPROACH</b></p> <table border="1"> <tr><th>1/2 ss</th><th>2</th><th>4</th><th>6</th><th>8</th><th>9</th></tr> <tr><td>1</td><td>3</td><td>5</td><td>7</td><td>9</td><td>-</td></tr> <tr><td>0.0</td><td>0.1</td><td>0.3</td><td>0.5</td><td>0.7</td><td>-</td></tr> </table>		1/2 ss	2	4	6	8	9	1	3	5	7	9	-	0.0	0.1	0.3	0.5	0.7	-																																																
1/2 ss	2	4	6	8	10																																																																																		
2	4	6	8	10	-																																																																																		
0.2	0.4	0.6	0.8	1.0	-																																																																																		
1/2 ss	2	4	6	8	9																																																																																		
1	3	5	7	9	-																																																																																		
0.0	0.1	0.3	0.5	0.7	-																																																																																		
<p><b>C. TWISTS BARANI ENTRY</b></p> <table border="1"> <tr><th>1/2 ss</th><th>2</th><th>4</th><th>6</th><th>8</th><th>10</th></tr> <tr><td>1</td><td>0.0</td><td>0.0</td><td>0.0</td><td>0.0</td><td>0.0</td></tr> <tr><td>3</td><td>0.2</td><td>0.4</td><td>0.6</td><td>0.8</td><td>1.0</td></tr> <tr><td>5</td><td>0.5</td><td>0.9</td><td>1.3</td><td>1.7</td><td>2.1</td></tr> <tr><td>7</td><td>0.9</td><td>1.5</td><td>2.1</td><td>2.7</td><td>3.3</td></tr> <tr><td>9</td><td>1.4</td><td>2.2</td><td>3.0</td><td>3.8</td><td>4.6</td></tr> </table>		1/2 ss	2	4	6	8	10	1	0.0	0.0	0.0	0.0	0.0	3	0.2	0.4	0.6	0.8	1.0	5	0.5	0.9	1.3	1.7	2.1	7	0.9	1.5	2.1	2.7	3.3	9	1.4	2.2	3.0	3.8	4.6	<p><b>C1. TWISTS BARANI ENTRY</b></p> <table border="1"> <tr><th>1/2 ss</th><th>2</th><th>4</th><th>6</th><th>8</th><th>9</th></tr> <tr><td>1</td><td>0.0</td><td>0.0</td><td>0.0</td><td>0.0</td><td>0.0</td></tr> <tr><td>3</td><td>0.2</td><td>0.3</td><td>0.4</td><td>0.6</td><td>0.8</td></tr> <tr><td>5</td><td>0.5</td><td>0.7</td><td>0.9</td><td>1.3</td><td>1.7</td></tr> <tr><td>7</td><td>0.9</td><td>1.2</td><td>1.5</td><td>2.1</td><td>2.7</td></tr> <tr><td>9</td><td>1.4</td><td>1.8</td><td>2.2</td><td>3.0</td><td>3.8</td></tr> </table>		1/2 ss	2	4	6	8	9	1	0.0	0.0	0.0	0.0	0.0	3	0.2	0.3	0.4	0.6	0.8	5	0.5	0.7	0.9	1.3	1.7	7	0.9	1.2	1.5	2.1	2.7	9	1.4	1.8	2.2	3.0	3.8												
1/2 ss	2	4	6	8	10																																																																																		
1	0.0	0.0	0.0	0.0	0.0																																																																																		
3	0.2	0.4	0.6	0.8	1.0																																																																																		
5	0.5	0.9	1.3	1.7	2.1																																																																																		
7	0.9	1.5	2.1	2.7	3.3																																																																																		
9	1.4	2.2	3.0	3.8	4.6																																																																																		
1/2 ss	2	4	6	8	9																																																																																		
1	0.0	0.0	0.0	0.0	0.0																																																																																		
3	0.2	0.3	0.4	0.6	0.8																																																																																		
5	0.5	0.7	0.9	1.3	1.7																																																																																		
7	0.9	1.2	1.5	2.1	2.7																																																																																		
9	1.4	1.8	2.2	3.0	3.8																																																																																		
<p><b>D. TWISTS BLIND ENTRY</b></p> <table border="1"> <tr><th>1/2 ss</th><th>2</th><th>4</th><th>6</th><th>8</th><th>10</th></tr> <tr><td>1</td><td>0.0</td><td>0.0</td><td>0.0</td><td>0.0</td><td>0.0</td></tr> <tr><td>2</td><td>0.5</td><td>0.8</td><td>1.1</td><td>1.5</td><td>1.9</td></tr> <tr><td>4</td><td>-</td><td>1.4</td><td>1.9</td><td>2.5</td><td>-</td></tr> <tr><td>6</td><td>-</td><td>2.1</td><td>2.8</td><td>3.6</td><td>-</td></tr> <tr><td>8</td><td>-</td><td>2.9</td><td>3.8</td><td>-</td><td>-</td></tr> </table>		1/2 ss	2	4	6	8	10	1	0.0	0.0	0.0	0.0	0.0	2	0.5	0.8	1.1	1.5	1.9	4	-	1.4	1.9	2.5	-	6	-	2.1	2.8	3.6	-	8	-	2.9	3.8	-	-	<p><b>D1. TWISTS BLIND ENTRY</b></p> <table border="1"> <tr><th>1/2 ss</th><th>2</th><th>4</th><th>6</th><th>8</th><th>9</th></tr> <tr><td>1</td><td>0.0</td><td>0.0</td><td>0.0</td><td>0.0</td><td>0.0</td></tr> <tr><td>2</td><td>0.6</td><td>0.9</td><td>1.3</td><td>1.7</td><td>-</td></tr> <tr><td>4</td><td>-</td><td>1.1</td><td>1.5</td><td>2.1</td><td>-</td></tr> <tr><td>6</td><td>-</td><td>-</td><td>2.2</td><td>-</td><td>-</td></tr> <tr><td>8</td><td>-</td><td>-</td><td>-</td><td>-</td><td>-</td></tr> </table>		1/2 ss	2	4	6	8	9	1	0.0	0.0	0.0	0.0	0.0	2	0.6	0.9	1.3	1.7	-	4	-	1.1	1.5	2.1	-	6	-	-	2.2	-	-	8	-	-	-	-	-												
1/2 ss	2	4	6	8	10																																																																																		
1	0.0	0.0	0.0	0.0	0.0																																																																																		
2	0.5	0.8	1.1	1.5	1.9																																																																																		
4	-	1.4	1.9	2.5	-																																																																																		
6	-	2.1	2.8	3.6	-																																																																																		
8	-	2.9	3.8	-	-																																																																																		
1/2 ss	2	4	6	8	9																																																																																		
1	0.0	0.0	0.0	0.0	0.0																																																																																		
2	0.6	0.9	1.3	1.7	-																																																																																		
4	-	1.1	1.5	2.1	-																																																																																		
6	-	-	2.2	-	-																																																																																		
8	-	-	-	-	-																																																																																		
<p><b>E. BLIND ENTRY</b></p> <table border="1"> <tr><th>1/2 ss</th><th>2</th><th>4</th><th>6</th><th>8</th><th>10</th></tr> <tr><td>2</td><td>4</td><td>6</td><td>8</td><td>10</td><td>-</td></tr> <tr><td>0.3</td><td>0.4</td><td>0.5</td><td>0.7</td><td>0.9</td><td>-</td></tr> </table>		1/2 ss	2	4	6	8	10	2	4	6	8	10	-	0.3	0.4	0.5	0.7	0.9	-	<p><b>E1. BLIND ENTRY</b></p> <table border="1"> <tr><th>1/2 ss</th><th>2</th><th>4</th><th>6</th><th>8</th><th>9</th></tr> <tr><td>1</td><td>3</td><td>5</td><td>7</td><td>9</td><td>-</td></tr> <tr><td>0.1</td><td>0.3</td><td>0.5</td><td>0.7</td><td>0.9</td><td>-</td></tr> </table>		1/2 ss	2	4	6	8	9	1	3	5	7	9	-	0.1	0.3	0.5	0.7	0.9	-																																																
1/2 ss	2	4	6	8	10																																																																																		
2	4	6	8	10	-																																																																																		
0.3	0.4	0.5	0.7	0.9	-																																																																																		
1/2 ss	2	4	6	8	9																																																																																		
1	3	5	7	9	-																																																																																		
0.1	0.3	0.5	0.7	0.9	-																																																																																		
FORWARD (GROUP 1)		REVERSE (GROUP 3)																																																																																					
2 - 52		3 - 53																																																																																					
<p><b>A. SOMERSAULTS</b></p> <table border="1"> <tr><th>1/2 ss</th><th>2</th><th>4</th><th>6</th><th>8</th><th>10</th></tr> <tr><td>2</td><td>4</td><td>6</td><td>8</td><td>10</td><td>-</td></tr> <tr><td>2.5</td><td>2.8</td><td>3.4</td><td>4.4</td><td>5.9</td><td>-</td></tr> </table>		1/2 ss	2	4	6	8	10	2	4	6	8	10	-	2.5	2.8	3.4	4.4	5.9	-	<p><b>A. SOMERSAULTS</b></p> <table border="1"> <tr><th>1/2 ss</th><th>2</th><th>4</th><th>6</th><th>8</th><th>10</th></tr> <tr><td>2</td><td>4</td><td>6</td><td>8</td><td>10</td><td>-</td></tr> <tr><td>2.5</td><td>2.8</td><td>3.4</td><td>4.4</td><td>5.9</td><td>-</td></tr> </table>		1/2 ss	2	4	6	8	10	2	4	6	8	10	-	2.5	2.8	3.4	4.4	5.9	-																																																
1/2 ss	2	4	6	8	10																																																																																		
2	4	6	8	10	-																																																																																		
2.5	2.8	3.4	4.4	5.9	-																																																																																		
1/2 ss	2	4	6	8	10																																																																																		
2	4	6	8	10	-																																																																																		
2.5	2.8	3.4	4.4	5.9	-																																																																																		
<p><b>B. APPROACH</b></p> <table border="1"> <tr><th>1/2 ss</th><th>2</th><th>4</th><th>6</th><th>8</th><th>10</th></tr> <tr><td>2</td><td>4</td><td>6</td><td>8</td><td>10</td><td>-</td></tr> <tr><td>0.2</td><td>0.3</td><td>0.4</td><td>0.5</td><td>0.6</td><td>-</td></tr> </table>		1/2 ss	2	4	6	8	10	2	4	6	8	10	-	0.2	0.3	0.4	0.5	0.6	-	<p><b>B. APPROACH</b></p> <table border="1"> <tr><th>1/2 ss</th><th>2</th><th>4</th><th>6</th><th>8</th><th>9</th></tr> <tr><td>1</td><td>3</td><td>5</td><td>7</td><td>9</td><td>-</td></tr> <tr><td>0.0</td><td>0.1</td><td>0.3</td><td>0.5</td><td>0.7</td><td>-</td></tr> </table>		1/2 ss	2	4	6	8	9	1	3	5	7	9	-	0.0	0.1	0.3	0.5	0.7	-																																																
1/2 ss	2	4	6	8	10																																																																																		
2	4	6	8	10	-																																																																																		
0.2	0.3	0.4	0.5	0.6	-																																																																																		
1/2 ss	2	4	6	8	9																																																																																		
1	3	5	7	9	-																																																																																		
0.0	0.1	0.3	0.5	0.7	-																																																																																		
<p><b>C. TWISTS</b></p> <table border="1"> <tr><th>1/2 ss</th><th>2</th><th>4</th><th>6</th><th>8</th><th>10</th></tr> <tr><td>2</td><td>0.0</td><td>0.0</td><td>0.0</td><td>0.0</td><td>0.0</td></tr> <tr><td>4</td><td>0.3</td><td>0.4</td><td>0.6</td><td>0.8</td><td>1.0</td></tr> <tr><td>6</td><td>0.7</td><td>0.9</td><td>1.3</td><td>1.7</td><td>2.1</td></tr> <tr><td>8</td><td>1.2</td><td>1.6</td><td>2.2</td><td>2.8</td><td>3.4</td></tr> <tr><td>10</td><td>1.9</td><td>2.5</td><td>3.3</td><td>4.1</td><td>4.9</td></tr> </table>		1/2 ss	2	4	6	8	10	2	0.0	0.0	0.0	0.0	0.0	4	0.3	0.4	0.6	0.8	1.0	6	0.7	0.9	1.3	1.7	2.1	8	1.2	1.6	2.2	2.8	3.4	10	1.9	2.5	3.3	4.1	4.9	<p><b>C1. TWISTS</b></p> <table border="1"> <tr><th>1/2 ss</th><th>2</th><th>4</th><th>6</th><th>8</th><th>9</th></tr> <tr><td>1</td><td>0.0</td><td>0.0</td><td>0.0</td><td>0.0</td><td>0.0</td></tr> <tr><td>4</td><td>0.2</td><td>0.3</td><td>0.5</td><td>0.7</td><td>0.9</td></tr> <tr><td>6</td><td>0.5</td><td>0.7</td><td>1.1</td><td>1.5</td><td>1.9</td></tr> <tr><td>8</td><td>0.9</td><td>1.2</td><td>1.8</td><td>2.4</td><td>3.0</td></tr> <tr><td>10</td><td>1.4</td><td>1.8</td><td>2.6</td><td>3.4</td><td>4.2</td></tr> </table>		1/2 ss	2	4	6	8	9	1	0.0	0.0	0.0	0.0	0.0	4	0.2	0.3	0.5	0.7	0.9	6	0.5	0.7	1.1	1.5	1.9	8	0.9	1.2	1.8	2.4	3.0	10	1.4	1.8	2.6	3.4	4.2												
1/2 ss	2	4	6	8	10																																																																																		
2	0.0	0.0	0.0	0.0	0.0																																																																																		
4	0.3	0.4	0.6	0.8	1.0																																																																																		
6	0.7	0.9	1.3	1.7	2.1																																																																																		
8	1.2	1.6	2.2	2.8	3.4																																																																																		
10	1.9	2.5	3.3	4.1	4.9																																																																																		
1/2 ss	2	4	6	8	9																																																																																		
1	0.0	0.0	0.0	0.0	0.0																																																																																		
4	0.2	0.3	0.5	0.7	0.9																																																																																		
6	0.5	0.7	1.1	1.5	1.9																																																																																		
8	0.9	1.2	1.8	2.4	3.0																																																																																		
10	1.4	1.8	2.6	3.4	4.2																																																																																		
<p><b>D. TWISTS BLIND ENTRY</b></p> <table border="1"> <tr><th>1/2 ss</th><th>2</th><th>4</th><th>6</th><th>8</th><th>10</th></tr> <tr><td>1</td><td>0.2</td><td>0.3</td><td>0.5</td><td>0.7</td><td>0.9</td></tr> <tr><td>3</td><td>-</td><td>0.6</td><td>1.0</td><td>1.4</td><td>-</td></tr> <tr><td>5</td><td>-</td><td>1.1</td><td>1.7</td><td>2.3</td><td>-</td></tr> <tr><td>7</td><td>-</td><td>1.8</td><td>2.6</td><td>3.4</td><td>-</td></tr> <tr><td>9</td><td>-</td><td>2.7</td><td>3.7</td><td>-</td><td>-</td></tr> </table>		1/2 ss	2	4	6	8	10	1	0.2	0.3	0.5	0.7	0.9	3	-	0.6	1.0	1.4	-	5	-	1.1	1.7	2.3	-	7	-	1.8	2.6	3.4	-	9	-	2.7	3.7	-	-	<p><b>D1. TWISTS BLIND ENTRY</b></p> <table border="1"> <tr><th>1/2 ss</th><th>2</th><th>4</th><th>6</th><th>8</th><th>9</th></tr> <tr><td>1</td><td>0.2</td><td>0.3</td><td>0.5</td><td>0.7</td><td>0.9</td></tr> <tr><td>3</td><td>-</td><td>0.6</td><td>1.0</td><td>1.4</td><td>-</td></tr> <tr><td>5</td><td>-</td><td>1.1</td><td>1.7</td><td>2.3</td><td>-</td></tr> <tr><td>7</td><td>-</td><td>1.7</td><td>2.5</td><td>3.3</td><td>-</td></tr> <tr><td>9</td><td>-</td><td>2.4</td><td>3.4</td><td>-</td><td>-</td></tr> </table>		1/2 ss	2	4	6	8	9	1	0.2	0.3	0.5	0.7	0.9	3	-	0.6	1.0	1.4	-	5	-	1.1	1.7	2.3	-	7	-	1.7	2.5	3.3	-	9	-	2.4	3.4	-	-												
1/2 ss	2	4	6	8	10																																																																																		
1	0.2	0.3	0.5	0.7	0.9																																																																																		
3	-	0.6	1.0	1.4	-																																																																																		
5	-	1.1	1.7	2.3	-																																																																																		
7	-	1.8	2.6	3.4	-																																																																																		
9	-	2.7	3.7	-	-																																																																																		
1/2 ss	2	4	6	8	9																																																																																		
1	0.2	0.3	0.5	0.7	0.9																																																																																		
3	-	0.6	1.0	1.4	-																																																																																		
5	-	1.1	1.7	2.3	-																																																																																		
7	-	1.7	2.5	3.3	-																																																																																		
9	-	2.4	3.4	-	-																																																																																		
<p><b>F. BACK CONTROL ENTRY</b></p> <table border="1"> <tr><th>1/2 ss</th><th>2</th><th>4</th><th>6</th><th>8</th><th>10</th></tr> <tr><td>2</td><td>4</td><td>6</td><td>8</td><td>10</td><td>-</td></tr> <tr><td>0.0</td><td>0.1</td><td>0.2</td><td>0.3</td><td>0.5</td><td>-</td></tr> </table>		1/2 ss	2	4	6	8	10	2	4	6	8	10	-	0.0	0.1	0.2	0.3	0.5	-	<p><b>F1. BACK CONTROL ENTRY</b></p> <table border="1"> <tr><th>1/2 ss</th><th>2</th><th>4</th><th>6</th><th>8</th><th>9</th></tr> <tr><td>1</td><td>3</td><td>5</td><td>7</td><td>9</td><td>-</td></tr> <tr><td>0.1</td><td>0.2</td><td>0.3</td><td>0.4</td><td>0.6</td><td>-</td></tr> </table>		1/2 ss	2	4	6	8	9	1	3	5	7	9	-	0.1	0.2	0.3	0.4	0.6	-																																																
1/2 ss	2	4	6	8	10																																																																																		
2	4	6	8	10	-																																																																																		
0.0	0.1	0.2	0.3	0.5	-																																																																																		
1/2 ss	2	4	6	8	9																																																																																		
1	3	5	7	9	-																																																																																		
0.1	0.2	0.3	0.4	0.6	-																																																																																		
FORWARD (GROUP 5)		REVERSE (GROUP 5)																																																																																					
6 - 64		6 - 63																																																																																					
<p><b>A1. SOMERSAULTS</b></p> <table border="1"> <tr><th>1/2 ss</th><th>2</th><th>4</th><th>6</th><th>8</th><th>10</th></tr> <tr><td>1</td><td>3</td><td>5</td><td>7</td><td>9</td><td>-</td></tr> <tr><td>2.6</td><td>2.9</td><td>3.4</td><td>4.4</td><td>4.1</td><td>-</td></tr> </table>		1/2 ss	2	4	6	8	10	1	3	5	7	9	-	2.6	2.9	3.4	4.4	4.1	-	<p><b>A1. SOMERSAULTS</b></p> <table border="1"> <tr><th>1/2 ss</th><th>2</th><th>4</th><th>6</th><th>8</th><th>10</th></tr> <tr><td>1</td><td>3</td><td>5</td><td>7</td><td>9</td><td>-</td></tr> <tr><td>2.5</td><td>2.8</td><td>3.4</td><td>4.4</td><td>4.4</td><td>-</td></tr> </table>		1/2 ss	2	4	6	8	10	1	3	5	7	9	-	2.5	2.8	3.4	4.4	4.4	-																																																
1/2 ss	2	4	6	8	10																																																																																		
1	3	5	7	9	-																																																																																		
2.6	2.9	3.4	4.4	4.1	-																																																																																		
1/2 ss	2	4	6	8	10																																																																																		
1	3	5	7	9	-																																																																																		
2.5	2.8	3.4	4.4	4.4	-																																																																																		
<p><b>B1. APPROACH</b></p> <table border="1"> <tr><th>1/2 ss</th><th>2</th><th>4</th><th>6</th><th>8</th><th>10</th></tr> <tr><td>1</td><td>3</td><td>5</td><td>7</td><td>9</td><td>-</td></tr> <tr><td>0.1</td><td>0.3</td><td>-</td><td>-</td><td>-</td><td>-</td></tr> </table>		1/2 ss	2	4	6	8	10	1	3	5	7	9	-	0.1	0.3	-	-	-	-	<p><b>B1. SOMERSAULTS</b></p> <table border="1"> <tr><th>1/2 ss</th><th>2</th><th>4</th><th>6</th><th>8</th><th>9</th></tr> <tr><td>1</td><td>3</td><td>5</td><td>7</td><td>9</td><td>-</td></tr> <tr><td>0.1</td><td>0.3</td><td>0.5</td><td>0.7</td><td>0.9</td><td>-</td></tr> </table>		1/2 ss	2	4	6	8	9	1	3	5	7	9	-	0.1	0.3	0.5	0.7	0.9	-																																																
1/2 ss	2	4	6	8	10																																																																																		
1	3	5	7	9	-																																																																																		
0.1	0.3	-	-	-	-																																																																																		
1/2 ss	2	4	6	8	9																																																																																		
1	3	5	7	9	-																																																																																		
0.1	0.3	0.5	0.7	0.9	-																																																																																		
<p><b>C1. TWISTS BARANI ENTRY</b></p> <table border="1"> <tr><th>1/2 ss</th><th>2</th><th>4</th><th>6</th><th>8</th><th>10</th></tr> <tr><td>1</td><td>0.0</td><td>0.0</td><td>0.0</td><td>0.0</td><td>0.0</td></tr> <tr><td>3</td><td>0.2</td><td>0.4</td><td>0.6</td><td>0.8</td><td>1.0</td></tr> <tr><td>5</td><td>0.5</td><td>0.7</td><td>0.9</td><td>1.3</td><td>1.7</td></tr> <tr><td>7</td><td>0.9</td><td>1.2</td><td>1.5</td><td>2.1</td><td>2.7</td></tr> <tr><td>9</td><td>1.4</td><td>1.8</td><td>2.2</td><td>3.0</td><td>3.8</td></tr> </table>		1/2 ss	2	4	6	8	10	1	0.0	0.0	0.0	0.0	0.0	3	0.2	0.4	0.6	0.8	1.0	5	0.5	0.7	0.9	1.3	1.7	7	0.9	1.2	1.5	2.1	2.7	9	1.4	1.8	2.2	3.0	3.8	<p><b>F1. BACK CONTROL ENTRY</b></p> <table border="1"> <tr><th>1/2 ss</th><th>2</th><th>4</th><th>6</th><th>8</th><th>9</th></tr> <tr><td>1</td><td>3</td><td>5</td><td>7</td><td>9</td><td>-</td></tr> <tr><td>0.1</td><td>0.2</td><td>0.3</td><td>0.4</td><td>0.6</td><td>-</td></tr> </table>		1/2 ss	2	4	6	8	9	1	3	5	7	9	-	0.1	0.2	0.3	0.4	0.6	-																														
1/2 ss	2	4	6	8	10																																																																																		
1	0.0	0.0	0.0	0.0	0.0																																																																																		
3	0.2	0.4	0.6	0.8	1.0																																																																																		
5	0.5	0.7	0.9	1.3	1.7																																																																																		
7	0.9	1.2	1.5	2.1	2.7																																																																																		
9	1.4	1.8	2.2	3.0	3.8																																																																																		
1/2 ss	2	4	6	8	9																																																																																		
1	3	5	7	9	-																																																																																		
0.1	0.2	0.3	0.4	0.6	-																																																																																		
<p><b>E1. BLIND ENTRY</b></p> <table border="1"> <tr><th>1/2 ss</th><th>2</th><th>4</th><th>6</th><th>8</th><th>10</th></tr> <tr><td>1</td><td>3</td><td>5</td><td>7</td><td>9</td><td>-</td></tr> <tr><td>0.1</td><td>0.3</td><td>-</td><td>-</td><td>-</td><td>-</td></tr> </table>		1/2 ss	2	4	6	8	10	1	3	5	7	9	-	0.1	0.3	-	-	-	-	<p><b>VALUE FOR ALL THE POSITIONS</b></p> <table border="1"> <tr><th>STAND. 1/2 ss</th><th>2</th><th>4</th><th>6</th><th>8</th><th>-</th></tr> <tr><th>ARM. 1/2 ss</th><th>1</th><th>3</th><th>5</th><th>7</th><th>-</th></tr> <tr><td>A</td><td>0.2</td><td>0.2</td><td>-</td><td>-</td><td>-</td></tr> <tr><td>B</td><td>0.0</td><td>0.0</td><td>0.0</td><td>0.0</td><td>-</td></tr> <tr><td>Flying B</td><td>0.1</td><td>0.1</td><td>0.2</td><td>0.4</td><td>-</td></tr> <tr><td>Mid-tum B</td><td>-</td><td>-</td><td>-</td><td>0.1</td><td>0.3</td></tr> <tr><td>C</td><td>-0.1</td><td>-0.2</td><td>-0.2</td><td>-0.3</td><td>-</td></tr> <tr><td>Flying C</td><td>0.0</td><td>-0.1</td><td>-0.1</td><td>-0.2</td><td>-</td></tr> <tr><td>Mid-tum C</td><td>-</td><td>-</td><td>-</td><td>0.0</td><td>0.0</td></tr> <tr><td>D</td><td>0.0</td><td>0.0</td><td>0.0</td><td>0.0</td><td>-</td></tr> <tr><td>E</td><td>0.1</td><td>0.1</td><td>0.2</td><td>0.4</td><td>-</td></tr> </table>		STAND. 1/2 ss	2	4	6	8	-	ARM. 1/2 ss	1	3	5	7	-	A	0.2	0.2	-	-	-	B	0.0	0.0	0.0	0.0	-	Flying B	0.1	0.1	0.2	0.4	-	Mid-tum B	-	-	-	0.1	0.3	C	-0.1	-0.2	-0.2	-0.3	-	Flying C	0.0	-0.1	-0.1	-0.2	-	Mid-tum C	-	-	-	0.0	0.0	D	0.0	0.0	0.0	0.0	-	E	0.1	0.1	0.2	0.4	-
1/2 ss	2	4	6	8	10																																																																																		
1	3	5	7	9	-																																																																																		
0.1	0.3	-	-	-	-																																																																																		
STAND. 1/2 ss	2	4	6	8	-																																																																																		
ARM. 1/2 ss	1	3	5	7	-																																																																																		
A	0.2	0.2	-	-	-																																																																																		
B	0.0	0.0	0.0	0.0	-																																																																																		
Flying B	0.1	0.1	0.2	0.4	-																																																																																		
Mid-tum B	-	-	-	0.1	0.3																																																																																		
C	-0.1	-0.2	-0.2	-0.3	-																																																																																		
Flying C	0.0	-0.1	-0.1	-0.2	-																																																																																		
Mid-tum C	-	-	-	0.0	0.0																																																																																		
D	0.0	0.0	0.0	0.0	-																																																																																		
E	0.1	0.1	0.2	0.4	-																																																																																		



# HIGH DIVING: 27 METRES

STANDING DIVES		ARMSTAND DIVES																																																																																	
A1-B1-C1-D1-E1-F1-POS=DD		A1+B1+C1+D1+E1+F1-POS=DD																																																																																	
<b>FORWARD (GROUP 1)</b>		<b>INWARD (GROUP 4)</b>																																																																																	
<b>1 - 51</b>		<b>4 - 54</b>																																																																																	
A. SOMERSAULTS	<table border="1"> <tr><td colspan="2">1/2 ss</td></tr> <tr><td>2</td><td>4</td><td>6</td><td>8</td><td>10</td><td>12</td></tr> <tr><td>2.6</td><td>2.9</td><td>3.4</td><td>4.1</td><td>5.1</td><td>6.4</td></tr> </table>	1/2 ss		2	4	6	8	10	12	2.6	2.9	3.4	4.1	5.1	6.4	A. SOMERSAULTS	<table border="1"> <tr><td colspan="2">1/2 ss</td></tr> <tr><td>2</td><td>4</td><td>6</td><td>8</td><td>10</td><td>12</td></tr> <tr><td>2.6</td><td>2.9</td><td>3.4</td><td>4.1</td><td>5.1</td><td>6.4</td></tr> </table>	1/2 ss		2	4	6	8	10	12	2.6	2.9	3.4	4.1	5.1	6.4																																																				
1/2 ss																																																																																			
2	4	6	8	10	12																																																																														
2.6	2.9	3.4	4.1	5.1	6.4																																																																														
1/2 ss																																																																																			
2	4	6	8	10	12																																																																														
2.6	2.9	3.4	4.1	5.1	6.4																																																																														
B. APPROACH	<table border="1"> <tr><td colspan="2">1/2 ss</td></tr> <tr><td>2</td><td>4</td><td>6</td><td>8</td><td>10</td><td>12</td></tr> <tr><td>0.0</td><td>0.0</td><td>0.0</td><td>0.0</td><td>0.0</td><td>0.0</td></tr> </table>	1/2 ss		2	4	6	8	10	12	0.0	0.0	0.0	0.0	0.0	0.0	B. APPROACH	<table border="1"> <tr><td colspan="2">1/2 ss</td></tr> <tr><td>2</td><td>4</td><td>6</td><td>8</td><td>10</td><td>12</td></tr> <tr><td>0.0</td><td>0.2</td><td>0.4</td><td>0.6</td><td>0.8</td><td>1.0</td></tr> </table>	1/2 ss		2	4	6	8	10	12	0.0	0.2	0.4	0.6	0.8	1.0																																																				
1/2 ss																																																																																			
2	4	6	8	10	12																																																																														
0.0	0.0	0.0	0.0	0.0	0.0																																																																														
1/2 ss																																																																																			
2	4	6	8	10	12																																																																														
0.0	0.2	0.4	0.6	0.8	1.0																																																																														
C. TWISTS BARANI ENTRY	<table border="1"> <tr><td colspan="2">1/2 ss</td></tr> <tr><td>1</td><td>0.0</td><td>0.0</td><td>0.0</td><td>0.0</td><td>0.0</td></tr> <tr><td>3</td><td>0.2</td><td>0.3</td><td>0.4</td><td>0.6</td><td>0.8</td></tr> <tr><td>5</td><td>0.7</td><td>0.9</td><td>1.3</td><td>1.7</td><td>-</td></tr> <tr><td>7</td><td>0.9</td><td>1.2</td><td>1.5</td><td>2.1</td><td>2.7</td></tr> <tr><td>9</td><td>1.4</td><td>1.8</td><td>2.2</td><td>3.0</td><td>3.8</td></tr> </table>	1/2 ss		1	0.0	0.0	0.0	0.0	0.0	3	0.2	0.3	0.4	0.6	0.8	5	0.7	0.9	1.3	1.7	-	7	0.9	1.2	1.5	2.1	2.7	9	1.4	1.8	2.2	3.0	3.8	C. TWISTS BARANI ENTRY	<table border="1"> <tr><td colspan="2">1/2 ss</td></tr> <tr><td>1</td><td>0.0</td><td>0.0</td><td>0.0</td><td>0.0</td><td>0.0</td></tr> <tr><td>3</td><td>0.3</td><td>0.4</td><td>0.5</td><td>0.7</td><td>0.9</td></tr> <tr><td>5</td><td>0.7</td><td>0.9</td><td>1.1</td><td>1.5</td><td>1.9</td></tr> <tr><td>7</td><td>1.2</td><td>1.5</td><td>1.8</td><td>2.4</td><td>3.0</td></tr> <tr><td>9</td><td>1.8</td><td>2.2</td><td>2.6</td><td>3.4</td><td>4.2</td></tr> </table>	1/2 ss		1	0.0	0.0	0.0	0.0	0.0	3	0.3	0.4	0.5	0.7	0.9	5	0.7	0.9	1.1	1.5	1.9	7	1.2	1.5	1.8	2.4	3.0	9	1.8	2.2	2.6	3.4	4.2																
1/2 ss																																																																																			
1	0.0	0.0	0.0	0.0	0.0																																																																														
3	0.2	0.3	0.4	0.6	0.8																																																																														
5	0.7	0.9	1.3	1.7	-																																																																														
7	0.9	1.2	1.5	2.1	2.7																																																																														
9	1.4	1.8	2.2	3.0	3.8																																																																														
1/2 ss																																																																																			
1	0.0	0.0	0.0	0.0	0.0																																																																														
3	0.3	0.4	0.5	0.7	0.9																																																																														
5	0.7	0.9	1.1	1.5	1.9																																																																														
7	1.2	1.5	1.8	2.4	3.0																																																																														
9	1.8	2.2	2.6	3.4	4.2																																																																														
D. TWISTS BLIND ENTRY	<table border="1"> <tr><td colspan="2">1/2 ss</td></tr> <tr><td>1/2 tw</td><td>2</td><td>4</td><td>6</td><td>8</td><td>10</td><td>12</td></tr> <tr><td>2</td><td>0.4</td><td>0.6</td><td>0.8</td><td>1.2</td><td>1.6</td><td>-</td></tr> <tr><td>4</td><td>-</td><td>1.1</td><td>1.4</td><td>2.0</td><td>-</td><td>-</td></tr> <tr><td>6</td><td>-</td><td>1.7</td><td>2.1</td><td>2.9</td><td>-</td><td>-</td></tr> <tr><td>8</td><td>-</td><td>-</td><td>2.9</td><td>-</td><td>-</td><td>-</td></tr> </table>	1/2 ss		1/2 tw	2	4	6	8	10	12	2	0.4	0.6	0.8	1.2	1.6	-	4	-	1.1	1.4	2.0	-	-	6	-	1.7	2.1	2.9	-	-	8	-	-	2.9	-	-	-	D. TWISTS BLIND ENTRY	<table border="1"> <tr><td colspan="2">1/2 ss</td></tr> <tr><td>1/2 tw</td><td>2</td><td>4</td><td>6</td><td>8</td><td>10</td><td>12</td></tr> <tr><td>2</td><td>0.6</td><td>0.8</td><td>1.0</td><td>1.4</td><td>1.8</td><td>-</td></tr> <tr><td>4</td><td>-</td><td>1.4</td><td>1.7</td><td>-</td><td>-</td><td>-</td></tr> <tr><td>6</td><td>-</td><td>2.1</td><td>2.5</td><td>-</td><td>-</td><td>-</td></tr> <tr><td>8</td><td>-</td><td>-</td><td>-</td><td>-</td><td>-</td><td>-</td></tr> </table>	1/2 ss		1/2 tw	2	4	6	8	10	12	2	0.6	0.8	1.0	1.4	1.8	-	4	-	1.4	1.7	-	-	-	6	-	2.1	2.5	-	-	-	8	-	-	-	-	-	-						
1/2 ss																																																																																			
1/2 tw	2	4	6	8	10	12																																																																													
2	0.4	0.6	0.8	1.2	1.6	-																																																																													
4	-	1.1	1.4	2.0	-	-																																																																													
6	-	1.7	2.1	2.9	-	-																																																																													
8	-	-	2.9	-	-	-																																																																													
1/2 ss																																																																																			
1/2 tw	2	4	6	8	10	12																																																																													
2	0.6	0.8	1.0	1.4	1.8	-																																																																													
4	-	1.4	1.7	-	-	-																																																																													
6	-	2.1	2.5	-	-	-																																																																													
8	-	-	-	-	-	-																																																																													
E. BLIND ENTRY	<table border="1"> <tr><td colspan="2">1/2 ss</td></tr> <tr><td>2</td><td>4</td><td>6</td><td>8</td><td>10</td><td>12</td></tr> <tr><td>0.2</td><td>0.3</td><td>0.4</td><td>0.6</td><td>0.8</td><td>1.0</td></tr> </table>	1/2 ss		2	4	6	8	10	12	0.2	0.3	0.4	0.6	0.8	1.0	E. BLIND ENTRY	<table border="1"> <tr><td colspan="2">1/2 ss</td></tr> <tr><td>2</td><td>4</td><td>6</td><td>8</td><td>10</td><td>12</td></tr> <tr><td>0.3</td><td>0.4</td><td>0.5</td><td>0.7</td><td>0.9</td><td>1.1</td></tr> </table>	1/2 ss		2	4	6	8	10	12	0.3	0.4	0.5	0.7	0.9	1.1																																																				
1/2 ss																																																																																			
2	4	6	8	10	12																																																																														
0.2	0.3	0.4	0.6	0.8	1.0																																																																														
1/2 ss																																																																																			
2	4	6	8	10	12																																																																														
0.3	0.4	0.5	0.7	0.9	1.1																																																																														
<b>FORWARD (GROUP 5)</b>		<b>BACK (GROUP 5)</b>																																																																																	
<b>6 - 61</b>		<b>6 - 62</b>																																																																																	
A1. SOMERSAULTS	<table border="1"> <tr><td colspan="2">1/2 ss</td></tr> <tr><td>1</td><td>3</td><td>5</td><td>7</td><td>9</td></tr> <tr><td>2.6</td><td>2.9</td><td>3.4</td><td>4.1</td><td>5.1</td></tr> </table>	1/2 ss		1	3	5	7	9	2.6	2.9	3.4	4.1	5.1	A1. SOMERSAULTS	<table border="1"> <tr><td colspan="2">1/2 ss</td></tr> <tr><td>1</td><td>3</td><td>5</td><td>7</td><td>9</td></tr> <tr><td>2.6</td><td>2.9</td><td>3.4</td><td>4.1</td><td>5.1</td></tr> </table>	1/2 ss		1	3	5	7	9	2.6	2.9	3.4	4.1	5.1																																																								
1/2 ss																																																																																			
1	3	5	7	9																																																																															
2.6	2.9	3.4	4.1	5.1																																																																															
1/2 ss																																																																																			
1	3	5	7	9																																																																															
2.6	2.9	3.4	4.1	5.1																																																																															
B1. APPROACH	<table border="1"> <tr><td colspan="2">1/2 ss</td></tr> <tr><td>1</td><td>3</td><td>5</td><td>7</td><td>9</td></tr> <tr><td>0.0</td><td>0.1</td><td>0.3</td><td>0.5</td><td>0.7</td></tr> </table>	1/2 ss		1	3	5	7	9	0.0	0.1	0.3	0.5	0.7	B1. APPROACH	<table border="1"> <tr><td colspan="2">1/2 ss</td></tr> <tr><td>1</td><td>3</td><td>5</td><td>7</td><td>9</td></tr> <tr><td>0.0</td><td>0.1</td><td>0.2</td><td>0.4</td><td>0.6</td></tr> </table>	1/2 ss		1	3	5	7	9	0.0	0.1	0.2	0.4	0.6																																																								
1/2 ss																																																																																			
1	3	5	7	9																																																																															
0.0	0.1	0.3	0.5	0.7																																																																															
1/2 ss																																																																																			
1	3	5	7	9																																																																															
0.0	0.1	0.2	0.4	0.6																																																																															
C1. TWISTS BARANI ENTRY	<table border="1"> <tr><td colspan="2">1/2 ss</td></tr> <tr><td>1</td><td>0.0</td><td>0.0</td><td>0.0</td><td>0.0</td></tr> <tr><td>3</td><td>0.2</td><td>0.3</td><td>0.4</td><td>0.6</td><td>0.8</td></tr> <tr><td>5</td><td>0.7</td><td>0.9</td><td>1.3</td><td>1.7</td><td>-</td></tr> <tr><td>7</td><td>0.9</td><td>1.2</td><td>1.5</td><td>2.1</td><td>2.7</td></tr> <tr><td>9</td><td>1.4</td><td>1.8</td><td>2.2</td><td>3.0</td><td>3.8</td></tr> </table>	1/2 ss		1	0.0	0.0	0.0	0.0	3	0.2	0.3	0.4	0.6	0.8	5	0.7	0.9	1.3	1.7	-	7	0.9	1.2	1.5	2.1	2.7	9	1.4	1.8	2.2	3.0	3.8	C1. TWISTS BARANI ENTRY	<table border="1"> <tr><td colspan="2">1/2 ss</td></tr> <tr><td>1</td><td>0.0</td><td>0.0</td><td>0.0</td><td>0.0</td><td>0.0</td></tr> <tr><td>3</td><td>0.3</td><td>0.4</td><td>0.5</td><td>0.7</td><td>0.9</td></tr> <tr><td>5</td><td>0.7</td><td>0.9</td><td>1.1</td><td>1.5</td><td>1.9</td></tr> <tr><td>7</td><td>1.2</td><td>1.5</td><td>1.8</td><td>2.4</td><td>3.0</td></tr> <tr><td>9</td><td>1.8</td><td>2.2</td><td>2.6</td><td>3.4</td><td>4.2</td></tr> </table>	1/2 ss		1	0.0	0.0	0.0	0.0	0.0	3	0.3	0.4	0.5	0.7	0.9	5	0.7	0.9	1.1	1.5	1.9	7	1.2	1.5	1.8	2.4	3.0	9	1.8	2.2	2.6	3.4	4.2																	
1/2 ss																																																																																			
1	0.0	0.0	0.0	0.0																																																																															
3	0.2	0.3	0.4	0.6	0.8																																																																														
5	0.7	0.9	1.3	1.7	-																																																																														
7	0.9	1.2	1.5	2.1	2.7																																																																														
9	1.4	1.8	2.2	3.0	3.8																																																																														
1/2 ss																																																																																			
1	0.0	0.0	0.0	0.0	0.0																																																																														
3	0.3	0.4	0.5	0.7	0.9																																																																														
5	0.7	0.9	1.1	1.5	1.9																																																																														
7	1.2	1.5	1.8	2.4	3.0																																																																														
9	1.8	2.2	2.6	3.4	4.2																																																																														
D1. TWISTS BLIND ENTRY	<table border="1"> <tr><td colspan="2">1/2 ss</td></tr> <tr><td>1/2 tw</td><td>1</td><td>3</td><td>5</td><td>7</td><td>9</td></tr> <tr><td>2</td><td>-</td><td>-</td><td>-</td><td>-</td><td>-</td></tr> <tr><td>4</td><td>-</td><td>-</td><td>-</td><td>-</td><td>-</td></tr> <tr><td>6</td><td>-</td><td>-</td><td>-</td><td>-</td><td>-</td></tr> <tr><td>8</td><td>-</td><td>-</td><td>-</td><td>-</td><td>-</td></tr> </table>	1/2 ss		1/2 tw	1	3	5	7	9	2	-	-	-	-	-	4	-	-	-	-	-	6	-	-	-	-	-	8	-	-	-	-	-	D1. TWISTS BLIND ENTRY	<table border="1"> <tr><td colspan="2">1/2 ss</td></tr> <tr><td>1/2 tw</td><td>1</td><td>3</td><td>5</td><td>7</td><td>9</td></tr> <tr><td>2</td><td>-</td><td>-</td><td>-</td><td>-</td><td>-</td></tr> <tr><td>4</td><td>-</td><td>-</td><td>-</td><td>-</td><td>-</td></tr> <tr><td>6</td><td>-</td><td>-</td><td>-</td><td>-</td><td>-</td></tr> <tr><td>8</td><td>-</td><td>-</td><td>-</td><td>-</td><td>-</td></tr> </table>	1/2 ss		1/2 tw	1	3	5	7	9	2	-	-	-	-	-	4	-	-	-	-	-	6	-	-	-	-	-	8	-	-	-	-	-																
1/2 ss																																																																																			
1/2 tw	1	3	5	7	9																																																																														
2	-	-	-	-	-																																																																														
4	-	-	-	-	-																																																																														
6	-	-	-	-	-																																																																														
8	-	-	-	-	-																																																																														
1/2 ss																																																																																			
1/2 tw	1	3	5	7	9																																																																														
2	-	-	-	-	-																																																																														
4	-	-	-	-	-																																																																														
6	-	-	-	-	-																																																																														
8	-	-	-	-	-																																																																														
E1. BLIND ENTRY	<table border="1"> <tr><td colspan="2">1/2 ss</td></tr> <tr><td>1</td><td>3</td><td>5</td><td>7</td><td>9</td></tr> <tr><td>0.1</td><td>0.3</td><td>0.5</td><td>0.7</td><td>0.9</td></tr> </table>	1/2 ss		1	3	5	7	9	0.1	0.3	0.5	0.7	0.9	E1. BLIND ENTRY	<table border="1"> <tr><td colspan="2">1/2 ss</td></tr> <tr><td>1</td><td>3</td><td>5</td><td>7</td><td>9</td></tr> <tr><td>0.1</td><td>0.3</td><td>0.5</td><td>0.7</td><td>0.9</td></tr> </table>	1/2 ss		1	3	5	7	9	0.1	0.3	0.5	0.7	0.9																																																								
1/2 ss																																																																																			
1	3	5	7	9																																																																															
0.1	0.3	0.5	0.7	0.9																																																																															
1/2 ss																																																																																			
1	3	5	7	9																																																																															
0.1	0.3	0.5	0.7	0.9																																																																															
<b>INWARD (GROUP 5)</b>		<b>REVERSE (GROUP 5)</b>																																																																																	
<b>6 - 64</b>		<b>6 - 63</b>																																																																																	
A1. SOMERSAULTS	<table border="1"> <tr><td colspan="2">1/2 ss</td></tr> <tr><td>1</td><td>3</td><td>5</td><td>7</td><td>9</td></tr> <tr><td>2.6</td><td>2.9</td><td>3.4</td><td>4.1</td><td>5.1</td></tr> </table>	1/2 ss		1	3	5	7	9	2.6	2.9	3.4	4.1	5.1	A1. SOMERSAULTS	<table border="1"> <tr><td colspan="2">1/2 ss</td></tr> <tr><td>1</td><td>3</td><td>5</td><td>7</td><td>9</td></tr> <tr><td>2.6</td><td>2.9</td><td>3.4</td><td>4.1</td><td>5.1</td></tr> </table>	1/2 ss		1	3	5	7	9	2.6	2.9	3.4	4.1	5.1																																																								
1/2 ss																																																																																			
1	3	5	7	9																																																																															
2.6	2.9	3.4	4.1	5.1																																																																															
1/2 ss																																																																																			
1	3	5	7	9																																																																															
2.6	2.9	3.4	4.1	5.1																																																																															
B1. APPROACH	<table border="1"> <tr><td colspan="2">1/2 ss</td></tr> <tr><td>1</td><td>3</td><td>5</td><td>7</td><td>9</td></tr> <tr><td>0.1</td><td>0.2</td><td>-</td><td>-</td><td>-</td></tr> </table>	1/2 ss		1	3	5	7	9	0.1	0.2	-	-	-	B1. APPROACH	<table border="1"> <tr><td colspan="2">1/2 ss</td></tr> <tr><td>1</td><td>3</td><td>5</td><td>7</td><td>9</td></tr> <tr><td>0.1</td><td>0.3</td><td>0.5</td><td>0.7</td><td>0.9</td></tr> </table>	1/2 ss		1	3	5	7	9	0.1	0.3	0.5	0.7	0.9																																																								
1/2 ss																																																																																			
1	3	5	7	9																																																																															
0.1	0.2	-	-	-																																																																															
1/2 ss																																																																																			
1	3	5	7	9																																																																															
0.1	0.3	0.5	0.7	0.9																																																																															
C1. TWISTS BARANI ENTRY	<table border="1"> <tr><td colspan="2">1/2 ss</td></tr> <tr><td>1</td><td>0.1</td><td>0.2</td><td>-</td><td>-</td></tr> </table>	1/2 ss		1	0.1	0.2	-	-	C1. TWISTS BARANI ENTRY	<table border="1"> <tr><td colspan="2">1/2 ss</td></tr> <tr><td>1</td><td>0.1</td><td>0.2</td><td>0.4</td><td>0.6</td></tr> </table>	1/2 ss		1	0.1	0.2	0.4	0.6																																																																		
1/2 ss																																																																																			
1	0.1	0.2	-	-																																																																															
1/2 ss																																																																																			
1	0.1	0.2	0.4	0.6																																																																															
E1. BLIND ENTRY	<table border="1"> <tr><td colspan="2">1/2 ss</td></tr> <tr><td>1</td><td>3</td><td>5</td><td>7</td><td>9</td></tr> <tr><td>0.1</td><td>0.3</td><td>-</td><td>-</td><td>-</td></tr> </table>	1/2 ss		1	3	5	7	9	0.1	0.3	-	-	-	E1. BLIND ENTRY	<table border="1"> <tr><td colspan="2">1/2 ss</td></tr> <tr><td>1</td><td>3</td><td>5</td><td>7</td><td>9</td></tr> <tr><td>0.0</td><td>0.1</td><td>0.2</td><td>0.3</td><td>0.4</td></tr> </table>	1/2 ss		1	3	5	7	9	0.0	0.1	0.2	0.3	0.4																																																								
1/2 ss																																																																																			
1	3	5	7	9																																																																															
0.1	0.3	-	-	-																																																																															
1/2 ss																																																																																			
1	3	5	7	9																																																																															
0.0	0.1	0.2	0.3	0.4																																																																															
<p><b>VALUES FOR ALL THE POSITIONS</b></p> <table border="1"> <tr><th>STAND.</th><th>1/2 ss</th><th>2</th><th>4</th><th>6</th><th>8</th><th>10</th><th>12</th></tr> <tr><td>A</td><td>0.2</td><td>0.2</td><td>-</td><td>-</td><td>-</td><td>-</td><td>-</td></tr> <tr><td>B</td><td>0.0</td><td>0.0</td><td>0.0</td><td>0.0</td><td>0.0</td><td>0.0</td><td>0.0</td></tr> <tr><td>Flying B</td><td>0.1</td><td>0.1</td><td>0.2</td><td>0.4</td><td>-</td><td>-</td><td>-</td></tr> <tr><td>Mid-tum B</td><td>-</td><td>-</td><td>-</td><td>0.1</td><td>0.3</td><td>0.5</td><td>-</td></tr> <tr><td>C</td><td>-0.1</td><td>-0.2</td><td>-0.3</td><td>-0.5</td><td>-0.5</td><td>-0.5</td><td>-</td></tr> <tr><td>Flying C</td><td>0.0</td><td>-0.1</td><td>-0.1</td><td>-0.2</td><td>-</td><td>-</td><td>-</td></tr> <tr><td>Mid-tum C</td><td>-</td><td>-</td><td>0.0</td><td>0.0</td><td>0.0</td><td>0.2</td><td>-</td></tr> <tr><td>D</td><td>0.0</td><td>0.0</td><td>0.0</td><td>0.0</td><td>0.0</td><td>0.0</td><td>0.0</td></tr> <tr><td>E</td><td>0.1</td><td>0.1</td><td>0.1</td><td>0.2</td><td>0.4</td><td>-</td><td>-</td></tr> </table>				STAND.	1/2 ss	2	4	6	8	10	12	A	0.2	0.2	-	-	-	-	-	B	0.0	0.0	0.0	0.0	0.0	0.0	0.0	Flying B	0.1	0.1	0.2	0.4	-	-	-	Mid-tum B	-	-	-	0.1	0.3	0.5	-	C	-0.1	-0.2	-0.3	-0.5	-0.5	-0.5	-	Flying C	0.0	-0.1	-0.1	-0.2	-	-	-	Mid-tum C	-	-	0.0	0.0	0.0	0.2	-	D	0.0	0.0	0.0	0.0	0.0	0.0	0.0	E	0.1	0.1	0.1	0.2	0.4	-	-
STAND.	1/2 ss	2	4	6	8	10	12																																																																												
A	0.2	0.2	-	-	-	-	-																																																																												
B	0.0	0.0	0.0	0.0	0.0	0.0	0.0																																																																												
Flying B	0.1	0.1	0.2	0.4	-	-	-																																																																												
Mid-tum B	-	-	-	0.1	0.3	0.5	-																																																																												
C	-0.1	-0.2	-0.3	-0.5	-0.5	-0.5	-																																																																												
Flying C	0.0	-0.1	-0.1	-0.2	-	-	-																																																																												
Mid-tum C	-	-	0.0	0.0	0.0	0.2	-																																																																												
D	0.0	0.0	0.0	0.0	0.0	0.0	0.0																																																																												
E	0.1	0.1	0.1	0.2	0.4	-	-																																																																												
<p><b>F1. BACK CONTROL ENTRY</b></p> <table border="1"> <tr><td colspan="2">1/2 ss</td></tr> <tr><td>1</td><td>3</td><td>5</td><td>7</td><td>9</td></tr> <tr><td>0.0</td><td>0.1</td><td>0.2</td><td>0.3</td><td>0.4</td></tr> </table>				1/2 ss		1	3	5	7	9	0.0	0.1	0.2	0.3	0.4																																																																				
1/2 ss																																																																																			
1	3	5	7	9																																																																															
0.0	0.1	0.2	0.3	0.4																																																																															

**12.2 Tables of Degree of Difficulties**

Dive Number	Dive description	DD TABLE - 12 mts					DD TABLE - 15 mts				
		A	B	C	D	E	A	B	C	D	E
<b>Group 1 - Forward</b>											
102	Forward 1 Somersault	2,7	2,5	2,4		2,6	2,8	2,6	2,5		2,7
104	Forward 2 Somersaults		3,1	2,9		3,2		3,2	3,0		3,3
106	Forward 3 Somersaults		4,2	4,0		4,4		4,0	3,8		4,2
108	Forward 4 Somersaults		5,9	5,6				5,4	5,1		
112	Forward Flying 1 Somersault		2,6	2,5				2,7	2,6		
114	Forward Flying 2 Somersaults		3,2	3,0				3,3	3,1		
116	Forward Flying 3 Somersaults		4,4	4,1				4,2	3,9		
5121	Forward 1 Somersault 1/2 Twist		2,3	2,2				2,4	2,3		
5141	Forward 2 Somersaults 1/2 Twist		2,8	2,6		2,9		2,9	2,7		3,0
5(1)141	Forward Flying 2 Somersaults 1/2 Twist		2,9	2,7				3,0	2,8		
5161	Forward 3 Somersaults 1/2 Twist		3,8	3,6		4,0		3,6	3,4		3,8
5181	Forward 4 Somersaults 1/2 Twist		5,3	5,0				4,8	4,5		
5142	Forward 2 Somersaults 1 Twist				3,4						3,5
5143	Forward 2 Somersaults 1 1/2 Twist				3,1						3,2
5144	Forward 2 Somersaults 2 Twists				4,0						4,0
5145	Forward 2 Somersaults 2 1/2 Twists				3,6						3,6
5146	Forward 2 Somersaults 3 Twists				4,8						4,6
5147	Forward 2 Somersaults 3 1/2 Twists				4,3						4,1
5149	Forward 2 Somersaults 4 1/2 Twists				5,2						4,7
5162	Forward 3 Somersaults 1 Twist		4,7	4,5				4,5	4,3		
5163	Forward 3 Somersaults 1 1/2 Twist		4,3	4,1				4,1	3,9		
5164	Forward 3 Somersaults 2 Twists		5,5	5,3				5,2	5,0		
5165	Forward 3 Somersaults 2 1/2 Twists		5,0	4,8				4,7	4,5		
<b>Group 2 - Back</b>											
202	Back 1 Somersault	2,8	2,6	2,5		2,7	2,9	2,7	2,6		2,8
204	Back 2 Somersaults	3,3	3,1	2,9		3,2	3,4	3,2	3,0		3,3
206	Back 3 Somersaults		4,4	4,2		4,6		4,0	3,8		4,2
208	Back 4 Somersaults		6,2	5,9				5,4	5,1		
20(10)	Back 5 Somersaults								6,9		
212	Back Flying 1 Somersault		2,7	2,6				2,8	2,7		
214	Back Flying 2 Somersaults		3,2	3,0				3,3	3,1		
5241	Back 2 Somersaults 1/2 Twist				3,4						3,5
5242	Back 2 Somersaults 1 Twist				3,1						3,2
5243	Back 2 Somersaults 1 1/2 Twist				3,8						3,8
5244	Back 2 Somersaults 2 Twists				3,5						3,5
5245	Back 2 Somersaults 2 1/2 Twists				4,5						4,3
5246	Back 2 Somersaults 3 Twists				4,1						3,9
5248	Back 2 Somersaults 4 Twists				4,9						4,5
5261	Back 3 Somersaults 1/2 Twist		4,7	4,5				4,5	4,3		
5262	Back 3 Somersaults 1 Twist		4,2	4,0				4,0	3,8		
5263	Back 3 Somersaults 1 1/2 Twist		5,3	5,1				5,0	4,8		
5264	Back 3 Somersaults 2 Twists		4,8	4,6				4,5	4,3		
5265	Back 3 Somersaults 2 1/2 Twist		6,2	6,0				5,7	5,5		
5266	Back 3 Somersaults 3 Twists		5,6	5,4				5,1	4,9		
5282	Back 4 Somersaults 1 Twist		5,8	5,5				5,3	5,0		
<b>Group 3 - Reverse</b>											
302	Reverse 1 Somersault	2,9	2,7	2,6		2,8	2,9	2,7	2,6		2,8
304	Reverse 2 Somersaults		3,3	3,1		3,4		3,3	3,1		3,4
306	Reverse 3 Somersaults		4,5	4,3				4,2	4,0		
308	Reverse 4 Somersaults		6,4	6,1				5,7	5,4		
312	Reverse Flying 1 Somersault		2,8	2,7				2,8	2,7		
5341	Reverse 2 Somersaults 1/2 Twist				3,5						3,6
5342	Reverse 2 Somersaults 1 Twist				3,2						3,3
5343	Reverse 2 Somersaults 1 1/2 Twist				3,9						4,0
5344	Reverse 2 Somersaults 2 Twists				3,6						3,7
5345	Reverse 2 Somersaults 2 1/2 Twists				4,7						4,6
5346	Reverse 2 Somersaults 3 Twists				4,3						4,2
5347	Reverse 2 Somersaults 3 1/2 Twists				5,8						5,3
5348	Reverse 2 Somersaults 4 Twists				5,3						4,8
5361	Reverse 3 Somersaults 1/2 Twist		4,8	4,6				4,6	4,4		



Dive Number	Dive description	DD TABLE - 12 mts					DD TABLE - 15 mts				
		A	B	C	D	E	A	B	C	D	E
<b>Group 4 - Inward</b>											
402	Inward 1 Somersault		2,9	2,8		3,0		3,0	2,9		3,1
404	Inward 2 Somersaults		3,6	3,4				3,7	3,5		
406	Inward 3 Somersaults		4,9	4,7				4,7	4,5		
412	Inward Flying 1 Somersault		3,0	2,9				3,1	3,0		
5421	Inward 1 Somersault 1/2 Twist		2,6	2,5				2,7	2,6		
5441	Inward 2 Somersaults 1/2 Twist		3,2	3,0		3,3		3,3	3,1		3,4
5461	Inward 3 Somersaults 1/2 Twist		4,4	4,2				4,2	4,0		
5481	Inward 4 Somersaults 1/2 Twist		6,2	5,9				5,7	5,4		
5442	Inward 2 Somersaults 1 Twist					4,0					4,1
5443	Inward 2 Somersaults 1 1/2 Twist					3,6					3,7
<b>Group 5 - Armstand</b>											
611	Armstand Forward 1/2 Somersault	2,6	2,4	2,3			2,7	2,5	2,4		
613	Armstand Forward 1 1/2 Somersaults		3,1	2,9				3,2	3,0		
615	Armstand Forward 2 1/2 Somersaults		4,5	4,3				4,3	4,1		
6131	Arm. Forward 1 1/2 Somersault 1/2 Twist					2,8					2,9
6151	Arm. Forward 2 1/2 Somersaults 1/2 Twist		4,0	3,8				3,8	3,6		
621	Arm. Back 1/2 Somersault	2,7	2,5	2,4			2,8	2,6	2,5		
623	Arm. Back 1 1/2 Somersault	3,2	3,0	2,8			3,3	3,1	2,9		
625	Arm. Back 2 1/2 Somersaults		4,4	4,2				4,2	4,0		
627	Arm. Back 3 1/2 Somersaults		6,2	5,9				5,7	5,4		
631	Arm. Reverse 1/2 Somersault	2,8	2,6	2,5			2,9	2,7	2,6		
633	Arm. Reverse 1 1/2 Somersault		3,3	3,1				3,4	3,2		
635	Arm. Reverse 2 1/2 Somersaults		4,5	4,3				4,3	4,1		
6132	Arm. Forward 1 1/2 Somersault 1 Twist					3,6					3,7
6133	Arm. Forward 1 1/2 Somersault 1 1/2 Twist					3,3					3,4
6134	Arm. Forward 1 1/2 Somersault 2 Twists					4,4					4,4
6135	Arm. Forward 1 1/2 Somersault 2 1/2 Twists					4,0					4,0
6152	Arm. Forward 2 1/2 Somersaults 1 Twist		5,2	5,0				4,9	4,7		
6153	Arm. Forward 2 1/2 Somersaults 1 1/2 Twist		4,7	4,5				4,4	4,2		
6254	Arm. Forward 2 1/2 Somersaults 2 Twists										4,4
6271	Arm Back 3 1/2 Somersaults 1/2 Twist		6,5	6,2				6,0	5,7		
6272	Arm. Back 3 1/2 Somersaults 1 Twist		5,8	5,5				5,3	5,0		

	Blind entry
	Flying dive
	Back rotation control entry



Dive Number	Dive description	DD TABLE 27m					DD TABLE 20m				
		A	B	C	D	E	A	B	C	D	E
<b>Group 1 - Forward</b>											
102	Forward 1 Somersault		2,8	2,7		2,9		2,7	2,6		2,8
104	Forward 2 Somersaults		3,2	3,0		3,3		3,1	2,9		3,2
106	Forward 3 Somersaults		3,8	3,6				3,8	3,6		
108	Forward 4 Somersaults		4,7	4,4				5,0	4,7		
112	Forward Flying 1 Somersault		2,9	2,8				2,8	2,7		
114	Forward Flying 2 Somersaults		3,3	3,1				3,2	3,0		
116	Forward Flying 3 Somersaults		4,0	3,7				4,0	3,7		
5121	Forward 1 Somersault 1/2 Twist		2,6	2,5				2,5	2,4		
5141	Forward 2 Somersaults 1/2 Twist		2,9	2,7		3,0		2,8	2,6		2,9
5(1)141	Forward Flying 2 Somersaults 1/2 Twist		3,0	2,8				2,9	2,7		
5161	Forward 3 Somersaults 1/2 Twist		3,4	3,2		3,6		3,4	3,2		3,6
5181	Forward 4 Somersaults 1/2 Twist		4,1	3,8				4,4	4,1		
51(10)1	Forward 5 Somersaults 1/2 Twist		5,1	4,6							
51(12)1	Forward 6 Somersaults 1/2 Twist		6,4	5,9							
5142	Forward 2 Somersaults 1 Twist				3,5						3,4
5143	Forward 2 Somersaults 1 1/2 Twist				3,2						3,1
5144	Forward 2 Somersaults 2 Twists				4,0						3,9
5145	Forward 2 Somersaults 2 1/2 Twists				3,6						3,5
5146	Forward 2 Somersaults 3 Twists				4,6						4,5
5147	Forward 2 Somersaults 3 1/2 Twists				4,1						4,0
5149	Forward 2 Somersaults 4 1/2 Twists				4,7						4,6
5162	Forward 3 Somersaults 1 Twist		4,2	4,0				4,3	4,1		
5163	Forward 3 Somersaults 1 1/2 Twist		3,8	3,6				3,9	3,7		
5164	Forward 3 Somersaults 2 Twists		4,8	4,6				5,0	4,8		
5165	Forward 3 Somersaults 2 1/2 Twists		4,3	4,1				4,5	4,3		
5166	Forward 3 Somersaults 3 Twists				5,5						5,8
5167	Forward 3 Somersaults 3 1/2 Twists				4,9						
5169	Forward 3 Somersaults 4 1/2 Twists				5,6						
5182	Forward 4 Somersaults 1 Twist		5,3	5,0							
5183	Forward 4 Somersaults 1 1/2 Twist		4,7	4,4							
5185	Forward 4 Somersaults 2 1/2 Twists		5,4	5,1							
5187	Forward 4 Somersaults 3 1/2 twists		6,2	5,9							
<b>Group 2 - Back</b>											
202	Back 1 Somersault	2,9	2,7	2,6		2,8	2,9	2,7	2,6		2,8
204	Back 2 Somersaults	3,3	3,1	2,9			3,4	3,2	3,0		
206	Back 3 Somersaults		3,7	3,5				4,0	3,8		
208	Back 4 Somersaults		4,6	4,3				5,2	4,9		
20(10)	Back 5 Somersaults		5,8	5,3							
20(12)	Back 6 somersaults			6,7							
212	Back Flying 1 Somersault		2,8	2,7				2,8	2,7		
214	Back Flying 2 Somersaults		3,2	3,0				3,3	3,1		
216	Back Flying 3 Somersaults		3,9	3,6				4,2	3,9		
5241	Back 2 Somersaults 1/2 Twist				3,4						3,4
5242	Back 2 Somersaults 1 Twist				3,1						3,1
5243	Back 2 Somersaults 1 1/2 Twist				3,7						3,7
5244	Back 2 Somersaults 2 Twists				3,4						3,4
5245	Back 2 Somersaults 2 1/2 Twists				4,2						4,2
5246	Back 2 Somersaults 3 Twists				3,8						3,8
5247	Back 2 Somersaults 3 1/2 Twists				4,8						
5248	Back 2 Somersaults 4 Twists				4,3						4,4
524(10)	Back 2 Somersaults 5 Twists				5,0						
5261	Back 3 Somersaults 1/2 Twist		4,2	4,0				4,3	4,1		



Dive Number	Dive description	DD TABLE 27m					DD TABLE 20m				
		A	B	C	D	E	A	B	C	D	E
5262	Back 3 Somersaults 1 Twist		3,7	3,5				3,8	3,6		
5263	Back 3 Somersaults 1 1/2 Twist		4,6	4,4				4,8	4,6		
5264	Back 3 Somersaults 2 Twists		4,1	3,9				4,3	4,1		
5265	Back 3 Somersaults 2 1/2 Twist		5,2	5,0							
5266	Back 3 Somersaults 3 Twists		4,6	4,4				4,9	4,7		
5267	Back 3 Somersaults 3 1/2 Twists				5,9						
5268	Back 3 Somersaults 4 Twists				5,2						
526(10)	Back 3 Somersaults 5 Twists				6,0						
5281	Back 4 Somersaults 1/2 Twist		5,2	4,9							
5282	Back 4 Somersaults 1 Twist		4,5	4,2				4,9	4,6		
5283	Back 4 Somersaults 1 1/2 Twist		5,8	5,5							
5284	Back 4 Somersaults 2 Twists		5,1	4,8							
5286	Back 4 Somersaults 3 Twists		5,8	5,5							
52(10)2	Back 5 Somersaults 1 Twist		5,6	5,1							
<b>Group 3 - Reverse</b>											
302	Reverse 1 Somersault	2,9	2,7	2,6		2,8	2,9	2,7	2,6		2,8
304	Reverse 2 Somersaults		3,1	2,9				3,2	3,0		
306	Reverse 3 Somersaults		3,8	3,6				4,1	3,9		
308	Reverse 4 Somersaults		4,8	4,5				5,4	5,1		
30(10)	Reverse 5 Somersaults		6,1	5,6							
30(12)	Reverse 6 Somersaults			7,1							
312	Reverse Flying 1 Somersault		2,8	2,7				2,8	2,7		
5341	Reverse 2 Somersaults 1/2 Twist				3,4					3,4	
5342	Reverse 2 Somersaults 1 Twist				3,1					3,1	
5343	Reverse 2 Somersaults 1 1/2 Twist				3,8					3,8	
5344	Reverse 2 Somersaults 2 Twists				3,5					3,5	
5345	Reverse 2 Somersaults 2 1/2 Twists				4,4					4,4	
5346	Reverse 2 Somersaults 3 Twists				4,0					4,0	
5347	Reverse 2 Somersaults 3 1/2 Twists				5,1					5,2	
5348	Reverse 2 Somersaults 4 Twists				4,6						
534(10)	Reverse 2 Somersaults 5 Twists				5,4						
5361	Reverse 3 Somersaults 1/2 Twist		4,3	4,1				4,4	4,2		
5362	Reverse 3 Somersaults 1 Twist		3,8	3,6				3,9	3,7		
5363	Reverse 3 Somersaults 1 1/2 Twist		4,9	4,7							
5364	Reverse 3 Somersaults 2 Twists		4,4	4,2							
5365	Reverse 3 Somersaults 2 1/2 Twists		5,7	5,5							
5366	Reverse 3 Somersaults 3 Twists		5,1	4,9							
5368	Reverse 3 Somersaults 4 Twists				5,9						
5381	Reverse 4 Somersaults 1/2 Twist		5,4	5,1							
5382	Reverse 4 Somersaults 1 Twist		4,7	4,4							
<b>Group 4 - Inward</b>											
402	Inward 1 Somersault		2,9	2,8				3,0	2,9		
404	Inward 2 Somersaults		3,5	3,3				3,6	3,4		
406	Inward 3 Somersaults		4,3	4,1				4,5	4,3		
408	Inward 4 Somersaults		5,4	5,1				5,9	5,6		
412	Inward Flying 1 Somersault		3,0	2,9				3,1	3,0		
5421	Inward 1 Somersault 1/2 Twist		2,6	2,5				2,7	2,6		
5441	Inward 2 Somersaults 1/2 Twist		3,1	2,9				3,2	3,0		
5461	Inward 3 Somersaults 1/2 Twist		3,8	3,6				4,0	3,8		
5481	Inward 4 Somersaults 1/2 Twist		4,7	4,4				5,2	4,9		
54(10)1	Inward 5 Somersaults 1/2 Twist		5,9	5,4							
5442	Inward 2 Somersaults 1 Twist				3,9						
5443	Inward 2 Somersaults 1 1/2 Twist				3,5					3,6	
5445	Inward 2 Somersaults 2 1/2 Twists				4,0					4,1	
5447	Inward 2 Somersaults 3 1/2 Twists				4,6						
5462	Inward 3 Somersaults 1 Twist		4,8	4,6							
5463	Inward 3 Somersaults 1 1/2 Twist		4,3	4,1							



Dive Number	Dive description	DD TABLE 27m					DD TABLE 20m				
		A	B	C	D	E	A	B	C	D	E
<b>Group 5 - Armstand</b>											
611	Armstand Forward 1/2 Somersault		2,7	2,6				2,6	2,5		
613	Armstand Forward 1 1/2 Somersaults		3,3	3,1				3,2	3,0		
615	Armstand Forward 2 1/2 Somersaults		4,2	4,0				4,2	4,0		
6131	Arm. Forward 1 1/2 Somersault 1/2 Twist				3,0					2,9	
6151	Arm. Forward 2 1/2 Somersaults 1/2 Twist		3,7	3,5				3,7	3,5		
6171	Arm. Forward 3 1/2 Somersaults 1/2 Twist		4,6	4,3							
621	Arm. Back 1/2 Somersault	2,8	2,6	2,5			2,8	2,6	2,5		
623	Arm. Back 1 1/2 Somersault	3,3	3,1	2,9			3,3	3,1	2,9		
625	Arm. Back 2 1/2 Somersaults		3,8	3,6				4,0	3,8		
627	Arm. Back 3 1/2 Somersaults		4,8	4,5							
629	Arm. Back 4 1/2 Somersaults		6,1	5,6							
631	Arm. Reverse 1/2 Somersault		2,7	2,6				2,7	2,6		
633	Arm. Reverse 1 1/2 Somersault		3,3	3,1				3,3	3,1		
635	Arm. Reverse 2 1/2 Somersaults		4,1	3,9				4,2	4,0		
637	Arm. Reverse 3 1/2 Somersaults		5,1	4,8				5,5	5,2		
641	Arm. Inward 1/2 Somersault		2,8	2,7				2,8	2,7		
643	Arm. Inward 1 1/2 Somersault		3,4	3,2				3,5	3,3		
6431	Arm. Irward 1 1/2 Somersault 1/2 Twist				3,3					3,5	
6132	Arm. Forward 1 1/2 Somersault 1 Twist				3,6					3,5	
6133	Arm. Forward 1 1/2 Somersault 1 1/2 Twist				3,3					3,2	
6134	Arm. Forward 1 1/2 Somersault 2 Twists				4,1					4,0	
6135	Arm. Forward 1 1/2 Somersault 2 1/2 Twists				3,7					3,6	
6152	Arm. Forward 2 1/2 Somersaults 1 Twist		4,6	4,4				4,6	4,4		
6153	Arm. Forward 2 1/2 Somersaults 1 1/2 Twist		4,1	3,9				4,1	3,9		
6154	Arm. Forward 2 1/2 Somersaults 2 Twists				5,2						
6155	Arm. Forward 2 1/2 Somersaults 2 1/2 Twists				4,6						
6156	Arm. Forward 2 1/2 Somersaults 3 Twists				5,9						
6157	Arm. Forward 2 1/2 Somersaults 3 1/2 Twists				5,2						
6173	Arm. Forward 3 1/2 Somersaults 1 1/2 Twist		5,2	4,9							
6231	Arm Back 1 1/2 Somersault 1/2 Twist				3,3					3,2	
6232	Arm. Back 1 1/2 Somersault 1 Twist				3,0					2,9	
6233	Arm Back 1 1/2 Somersault 1 1/2 Twist				3,7					3,5	
6251	Arm Back 2 1/2 Somersault 1/2 Twist		4,1	3,9				4,2	4,0		
6252	Arm. Back 2 1/2 Somersaults 1 Twist		3,6	3,4				3,7	3,5		
6253	Arm Back 2 1/2 Somersaults 1 1/2 Twist		4,6	4,4				4,7	4,5		
6254	Arm. Back 2 1/2 Somersaults 2 Twists				4,1					4,2	
6255	Arm Back 2 1/2 Somersaults 2 1/2 Twists				5,3						
6256	Arm. Back 2 1/2 Somersaults 3 Twists				4,7					4,8	
6257	Arm Back 2 1/2 Somersaults 3 1/2 Twists				6,1						
6258	Arm. Back 2 1/2 Somersaults 4 Twists				5,4						
625(10)	Arm. Back 2 1/2 Somersaults 5 Twists				6,2						
6271	Arm Back 3 1/2 Somersaults 1/2 Twist		5,2	4,9							
6272	Arm. Back 3 1/2 Somersaults 1 Twist		4,5	4,2							
6273	Arm Back 3 1/2 Somersaults 1 1/2 Twist		5,9	5,6							
6274	Arm. Back 3 1/2 Somersault 2 Twists		5,2	4,9							
6276	Arm. Back 3 1/2 Somersault 3 Twists		6,0	5,7							

	Blind Entry
	Flying dive
	Back rotation control entry





WORLD  
AQUATICS

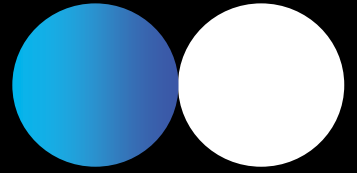

# WATER POLO

COMPETITION  
REGULATIONS

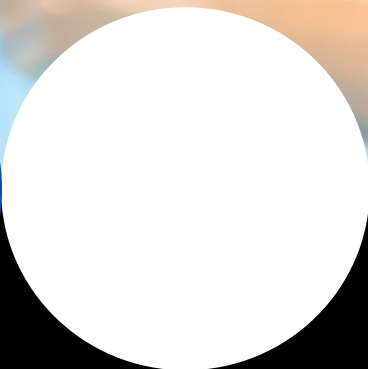



## TABLE OF CONTENTS

### PART SIX: WATER POLO RULES

<b>PART SIX: WATER POLO RULES</b> .....	<b>219</b>
<b>1</b> THE FIELD OF PLAY & EQUIPMENT.....	<b>219</b>
<b>2</b> TEAMS & PLAYERS.....	<b>219</b>
<b>3</b> REFEREES AND TECHNICAL OFFICIALS.....	<b>220</b>
<b>4</b> DURATION OF THE GAME.....	<b>220</b>
<b>5</b> TIMEOUTS.....	<b>221</b>
<b>6</b> START AND RESTART OF PLAY.....	<b>221</b>
<b>7</b> METHOD OF SCORING.....	<b>221</b>
<b>8</b> ORDINARY FOULS.....	<b>222</b>
<b>9</b> EXCLUSION FOULS.....	<b>223</b>
<b>10</b> PENALTY FOULS.....	<b>225</b>
<b>11</b> FREE THROWS.....	<b>226</b>
<b>12</b> GOAL THROWS.....	<b>226</b>
<b>13</b> CORNER THROWS.....	<b>226</b>
<b>14</b> NEUTRAL THROWS.....	<b>227</b>
<b>15</b> PENALTY THROWS.....	<b>227</b>
<b>16</b> PERSONAL FOULS, YELLOW AND RED CARDS.....	<b>228</b>
<b>17</b> ACCIDENT, INJURY AND ILLNESS.....	<b>229</b>
<b>18</b> WATER POLO FACILITIES.....	<b>229</b>
<b>19</b> BEACH WATER POLO RULES.....	<b>231</b>
<b>20</b> APPENDICES.....	<b>241</b>
20.1 APPENDIX 1 - DIAGRAMS.....	242
20.2 APPENDIX 2 - DIAGRAMS.....	243
20.3 APPENDIX 3 - DEFINITIONS.....	244
20.4 APPENDIX 4 - FIELD OF PLAY & EQUIPMENT.....	249
20.5 APPENDIX 5 - OFFICIALS.....	252
20.6 APPENDIX 6 - PENALTY SHOOT OUT.....	262
20.7 APPENDIX 7 - VAR PROTOCOL.....	265
20.8 APPENDIX 8 - AGE GROUP TOURNAMENTS.....	269
20.9 APPENDIX 9 - TOURNAMENT STRUCTURE.....	270
20.10 APPENDIX 10 – PROTOCOL FOR COACH’S CHALLENGE.....	286



## PART SIX: WATER POLO RULES

### 1 THE FIELD OF PLAY & EQUIPMENT

- 1.1** Features of the field of play, goals, ball and other equipment must be in accordance with Part Six, Appendix 4.
- 1.2** The distance between the goal lines shall be 25 metres. This shall apply to men's and women's matches.
- 1.3** An area for flying substitutions must be available on the lateral outer side of the field of play, on the side where the team benches are situated. The width of this area must be between 0.5m – 1m. The designated area for flying substitutions for each team will be between the goal line in front of the team bench and the centre of the field of play.

### 2 TEAMS & PLAYERS

#### Team composition

- 2.1** At World Aquatics events, or any event qualifying for a World Aquatics event, each team's start list shall consist of a maximum of fourteen eligible players. This start list shall include a maximum of twelve field players and a maximum of two goalkeepers.

Each team must have at least one goalkeeper on its start list. Even if a team has only one goalkeeper, the maximum number of field players remains at twelve. The goalkeeper must wear a red cap, as the red cap entitles the player to the privileges of a goalkeeper.

A team must start the match with seven players, one of whom must be a goalkeeper. Following the start of the match, a team is not obliged to have a goalkeeper in the water and may instead have seven field players.

If at any point, a team has no remaining eligible field players, either the registered goalkeeper or the registered substitute goalkeeper, may play as a field player. Similarly, if at any point, a team has no remaining viable goalkeepers, a registered field player may play as a goalkeeper, provided he or she wears a red cap.

- 2.2** All players not in the game at that time, together with the coaches and officials except for the head coach, must sit on the team bench and shall not move away from the bench from the commencement of play, except for substitutions and during the intervals between periods or during timeouts. The head coach of the attacking team may move to the 6 metre line at any time. Teams must only change ends and benches at half time. The team benches must both be situated on the side opposite to the official table.

- 2.3** The captains shall be playing members of their respective teams and, together with the head coach, they shall be responsible for the good conduct and discipline of the team.

- 2.4** Players shall wear non-transparent costumes or costumes with a separate undergarment and before taking part in a game shall remove any articles likely to cause injury.

- 2.5** Players shall not have grease, oil or any substance on the body, which might provide an advantage. If a referee determines before the start of play that such a substance has been used, the referee shall order it to be removed immediately. The start of play shall not be delayed for the substance to be removed. If the offence is detected after the play has started, the offending player shall be excluded from the remainder of the game and a substitute permitted to enter the field of play immediately from the team's exclusion re-entry area.

#### Substitution procedure

- 2.6** At any time in the game, a player or goalkeeper may be substituted by leaving the field of play at the team's exclusion re-entry area. The substitute may enter the field of play from the exclusion re-entry area as soon as the player has visibly risen to the surface of the water within the re-entry area. Substitution from the 'flying substitution' area is also allowed when the substitute enters the area from behind the extended goal line, both players, the exiting player and the substitute, are in the water, outside of the field of play and touch hands above the water. A substitute shall be ready to replace a player, without delay. If the substitute is not ready, the game shall continue without the substitute and, at any time, the substitute may then enter the field of play from the team's designated substitution areas, after touching hands where applicable. If a player leaves the field of play through the exclusion re-entry area or the 'flying substitution' area without being replaced by a substitute, the same player shall be permitted to re-enter the field of play from the same exclusion re-entry area or the 'flying substitution' area.



- 2.7** If the goalkeeper or substitute goalkeeper, if applicable, is not entitled or able to participate, a team playing with seven players shall be permitted to play with an alternate goalkeeper with the privileges of a goalkeeper. This player who substitutes for the goalkeeper shall wear a red cap with the same number as he/she was wearing as a field player. A goalkeeper who has been replaced by a substitute may not play in any position other than goalkeeper. The substitution and the cap - change for the alternate goalkeeper must be at the bench, and must follow the related rules of substitution.
- 2.8** No substitution shall be made under this Rule, except for bleeding or injury, between the time a referee awards a penalty throw (unless during a timeout) and the taking of the throw.
- 2.9** A substitute may enter the field of play from any place: (a) during the intervals between periods of play; (b) after a goal has been scored; (c) during a timeout; (d) to replace a player who is bleeding or injured.
- 2.10** If a player, on the player's own initiative, leaves the field of play for other than a substitution from the designated lateral substitution area in a place other than the exclusion re-entry area or the designated lateral substitution area, this player will not be punished for leaving the field of play and this player or a substitute will be able to (re-)enter the field of play from the exclusion re-entry area only with permission of the referee. The player may also re-enter after a goal, after a timeout or at the start of the next period.

### **3 REFEREES AND TECHNICAL OFFICIALS**

- 3.1** For World Aquatics events, the officials shall consist of two referees, two assistant referees, timekeepers and secretaries and a video assistant referee, each with the powers and duties specified in Part Six, Appendix 5 and following the procedures specified in Part Six, Appendix 7, if applicable.
- 3.2** To enforce the Rules, the referees shall be in absolute control of the game and their authority over players, team officials and spectators shall be effective from the moment they enter until they leave the venue of the match.
- 3.3** **The referees shall have the power:**
- to award or not award any ordinary, exclusion or penalty foul, while encouraging action and the advantage of the attacking team. A referee may award a foul or refrain from awarding a foul if awarding the foul would be an advantage to the offending player's team;
  - to order the removal from the precincts of the pool or the venue any player, substitute, spectator or official whose behaviour prevents the referees from carrying out their duties in a proper and impartial manner;
  - to abandon the game at any time if the behaviour of the players or spectators, or other circumstances prevent it from being brought to a proper conclusion.

### **4 DURATION OF THE GAME**

- 4.1** The duration of the game shall be four periods each of eight minutes actual play. Time shall commence at the start of each period when a player touches the ball. At all signals for stoppages, the time shall be stopped until the ball is put back into play by the ball leaving the hand of the player taking the appropriate throw or until the ball is touched by a player following a neutral throw.
- 4.1.1** The maximum ball possession time within a men's match is 25 seconds, whereas the maximum ball possession time within a women's match is 30 seconds.
- 4.2** There shall be a two-minute interval between the first and second periods and between the third and fourth periods and a three-minute interval between the second and third periods. The teams, including the players, coaches and officials, shall change ends before starting the third period.
- 4.3** Each World Aquatics Water Polo game shall have a winner at full time in any game. There shall be a penalty shoot out to determine the result as specified in Part Six, Appendix 6. If the teams are still tied following the completion of the initial five penalty shots, the same five players shall then take alternate shots until one team misses and the other scores.
- 4.4** If a game (or part of a game) must be replayed, then goals, personal fouls, and timeouts that occurred during the time to be replayed are deleted from the game score sheet, however, exclusions for violent action, misconduct, and any red card exclusions are recorded on the game score sheet.



## 5 TIMEOUTS

- 5.1** Each team may request two timeouts per game. The duration of the timeout shall be one minute. A timeout may be requested at any time, including after a goal, but not during VAR review, by the coach of the team in possession of the ball calling “timeout” and signalling to the jury table or the referee with the hands forming a T-shape. A team has possession of the ball when one of its players is holding or swimming with the ball. If a timeout is requested, the secretary or referee shall immediately stop the game by whistle and the players shall immediately return to their respective halves of the field of play. The timeout request can also be made by any device authorized for use in the game.
- 5.2** Play shall be restarted on the whistle of the referee by the team in possession of the ball putting the ball into play on or behind the half distance line, except that if the timeout is requested between the time a referee awards a penalty throw and the taking of the throw, that throw shall be maintained.
- 5.3** If the coach of the team in possession of the ball requests an additional timeout to which the team is not entitled, the game shall be stopped, and play shall then be restarted by a player of the opposing team putting the ball into play at the half distance line.
- 5.4** If the coach of the team not in possession of the ball requests a timeout, the game shall be stopped, and a penalty throw awarded to the opposing team. After requesting this illegal timeout, the coach shall lose the right to request a legal timeout if the team still has one.
- 5.5** At the restart following a timeout, players may take any position in the field of play, subject to the Rules relating to the taking of corner throws or penalty throws if the timeout is requested between the time a referee awards a penalty throw and the taking of the throw.

## 6 START AND RESTART OF PLAY

- 6.1** The first team listed in the official program will wear white caps or the caps reflecting the colour of their country and will start the game to the left of the official table. The other team will wear blue caps or caps of a contrasting colour and will start the game to the right of the jury table.
- 6.2** At the start of each period, the players must take up positions on their respective goal lines, about one metre apart and at least one metre from the goal posts. Not more than two players shall be allowed between the goal posts. No part of a player’s body shall be beyond the goal line at water level.
- 6.3** When the referees are satisfied that the teams are ready, a referee shall blow the whistle to start and then release or throw the ball into play on the half distance line.
- 6.4** After a goal has been scored, the players shall take up positions anywhere within their respective halves of the field of play. No part of a player’s body shall be beyond the half distance line at water level. A referee shall restart the game by blowing the whistle. At the time of the restart, actual play shall resume when the ball leaves the hand of a player of the team not having scored the goal. A restart not taken in accordance with this Rule shall be retaken.

## 7 METHOD OF SCORING

- 7.1** A goal shall be scored when the entire ball has passed fully over the goal line, between the goal posts and underneath the crossbar. The goal line is an imaginary laser line which runs on the front side from one goal post to the other post. A goal is scored when the ball fully passed the goal line as in position D and may be scored from anywhere within the field of play by any part of the body except a clenched fist.

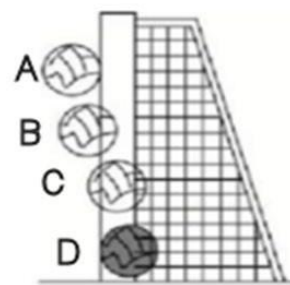

**7.2 A goal may be alternatively scored:**

- at the start or any restart of the game, after at least two players (of either team but excluding the defending goalkeeper) intentionally play or touch the ball;
- from a penalty throw;
- if a player throws the ball from a free throw into the player’s own goal;



- d) from an immediate shot from a goal throw or a corner throw or a free throw taken by a player outside 6 metres, except restarting after a goal, a timeout, a neutral throw, after the referee calls for the ball for an injury, replacement of a cap or for any other reason or when the ball leaves the side of the field of play;
- e) by a player who visibly puts the ball into play from a corner throw or outside 6 metres:
- from a goal throw;
  - after a swim up or the commencement of a period;
  - after a timeout or a goal;
  - after an injury;
  - after replacement of a cap;
  - after the referee calls for the ball or calls for a neutral throw;
  - when the ball leaves the side of the field of play;
  - taking a free throw awarded outside 6 metres;
  - after any other delay.
- f) by a player who visibly puts the ball into play inside 6 metres and swims outside 6 metres:
- after an injury;
  - after replacement of a cap;
  - after the referee calls for the ball or calls for a neutral throw;
  - when the ball leaves the side of the field of play;
  - taking a free throw;
  - after any other delay.

**7.3** A goal shall be counted if, at the expiration of possession time or at the end of a period, the ball is in flight or moving toward the goal and enters the goal, including after bouncing off the water, hitting the goal posts, goalkeeper or another player, except when intentionally played or touched by another attacking player.

## **8 ORDINARY FOULS**

**8.1** It shall be an ordinary foul to commit any of the following offences (Part Six, Articles 8.2 to 8.15), which shall be punished by awarding of a free throw to the opposing team, except as otherwise provided by the Rules.

**8.2** To advance beyond the goal line at the start of a period, before the referee has given the signal to start. The free throw shall be taken from the location of the ball or, if the ball has not been released into the field of play, from the half distance line.

**8.3** To assist a player at the start of a period or at any other time during the game.

**8.4** To hold or push off from the goal posts or their fixtures, to hold or push off from the sides or ends of the pool during actual play or at the start of a period.

**8.5** To take any active part in the game when standing on the floor of the pool, to walk when play is in progress or to jump from the floor of the pool to play the ball or tackle an opponent. This rule shall not apply to the goalkeeper while within the goalkeeper's 6 metre area.

**8.6** To take or hold the entire ball under the water when tackled or to deliberately hide it from the opposing team.

**8.7** To strike at the ball with a clenched fist, unless by the goalkeeper while within the 6 metre area.

**8.8** To play or touch the ball with two hands at the same time, unless by the goalkeeper while within the 6 metre area.

**8.9** To push or push off from an opponent who is not holding the ball.



**8.10** To be within the opponent's goal area except when behind the line of the ball. It shall not be an offence if a player is inside the 2 metre line but outside the goal area. Any player who is behind the line of the ball can enter the goal area to receive the ball. Any player inside the goal area who does not shoot but passes the ball backwards has to leave the goal area immediately to avoid being sanctioned under this rule.

**8.11** To take a free throw, goal throw, corner throw or a penalty throw other than in the prescribed manner except under the circumstances provided by Part Six, Article 12.2 and Part Six, Article 13.4.

**8.12** A team may retain possession for no more than (i) 25 seconds of actual play for the men's category and (ii) 30 seconds of actual play for the women's category without shooting at the opponent's goal.

The specific time limits for a team to retain possession of the ball without shooting at the opponent's goal, in the men's category, is summarized as follows (for which the timekeeper recording the possession time shall reset the clock):

- a) after the ball has left the hand of the player shooting at the goal, if the ball rebounds into play from the goal posts, a player or the goalkeeper, the possession time shall not recommence until the ball comes into the possession of one of the teams. The clock shall be reset to 15 seconds if the ball comes into possession of the attacking team. It shall be reset to 25 seconds if it comes into possession of the defending team;
- b) when the ball comes into the possession of the defending team, the clock shall be reset to 25 seconds of possession time.
- c) when the ball is put into play following the award of an exclusion foul to the defending player, the clock shall be reset to 15 seconds of possession time unless there are more than 15 seconds of possession time remaining, in which case the time shall continue and not be reset;
- d) when the ball is put into play following the taking of a penalty throw without a change of possession, or a corner throw, the clock shall be reset to 15 seconds of possession time. The clock shall also be reset to 15 seconds of possession time when the ball leaves the field of play through the side lines as a result of a deliberate action by a defender or the blocking of a shot by the defending goalkeeper;
- e) when the ball is put into play following the award of a penalty throw with a change of possession, a goal throw or neutral throw, the clock shall be reset to 25 seconds of possession time.

Visible clocks shall show the time in a descending manner (that is, showing the possession time remaining).

For the avoidance of doubt, all aforementioned rules are to be applied to the women's category, with the exception that all references to 25 seconds shall be replaced with 30 seconds.

**8.13** For a team to deliberately give up possession of the ball.

**8.14** To simulate being fouled.

**8.15** To go under the water to gain positional advantage.

## **9 EXCLUSION FOULS**

**9.1** It shall be an exclusion foul to commit any of the following offences (Part Six, Article 9.4 to 9.18) which shall be punished (except as otherwise provided by the Rules) by the award of a free throw to the opposing team and the exclusion of the player who committed the foul.

**9.2** An excluded player, including a player excluded from the remainder of the game, must immediately leave the field of play at any place, not leaving the water, and move to the exclusion re-entry area (visibly rising to the surface of the water) nearest to the player's own goal line without interfering with the play.

**9.3** The excluded player or a substitute shall be permitted to re-enter the field of play from the re-entry area nearest to the player's own goal line after the earliest occurrence when:

- a) 15 seconds of actual play have elapsed, at which time the secretary shall raise the appropriate flag, or with the use of any device authorized for use in the game signalling that the 15 seconds of actual play have elapsed
- b) a goal has been scored; an excluded player or a substitute may re-enter the field of play from any place.



- c) the excluded player's team has retaken possession of the ball during actual play, at which time the defensive referee shall signal re-entry by a hand signal;
- d) the excluded player's team is awarded a free throw, a goal throw or a penalty throw.

The excluded player or a substitute shall not be permitted to:

- jump or push off from the side or wall of the pool or the field of play;
- affect the alignment of the goal;
- enter for an excluded player until that player has reached the exclusion re-entry area nearest to the player's own goal line except between periods, after a goal, or during a timeout. These provisions shall also apply to the entry of a substitute when the excluded player has received three personal fouls or has otherwise been excluded from the remainder of the game in accordance with the Rules.

- 9.4** A player leaving the water (other than following the entry of a substitute) or sitting or standing on the steps or side of the pool during play, except in the case of accident, injury, illness or with the permission of a referee, shall be deemed guilty of an offence under Part Six, Article 9.13 (Misconduct).
- 9.5** To interfere with the taking of a free throw, goal throw or corner throw, including: (a) intentionally to throw away or fail to release the ball to prevent the normal progress of the game; (b) any attempt to play the ball before it has left the hand of the thrower.
- 9.6** To attempt to block a pass or shot with two hands outside the 6 metre area.
- 9.7** To intentionally splash in the face of an opponent.
- 9.8** To impede or otherwise prevent the free movement of an opponent who is not holding the ball, including swimming on the opponent's shoulders, back or legs or going under water hindering the positioning of an opponent. "Holding" is lifting, carrying or touching the ball but does not include dribbling the ball.
- 9.9** To hold, sink or pull back an opponent who is not holding the ball.
- 9.10** Anywhere in the field of play, to use two hands to hold an opponent not holding the ball.
- 9.11** Tactical foul. Anywhere in the field of play, for a defending player to commit a foul on any player of the team in possession of the ball with the intent to stop the flow of the attack. This kind of foul is called a tactical foul.
- 9.12** To make disproportionate movements including kicking and striking.
- 9.13** To be guilty of misconduct, including the use of unacceptable language, aggressive play, refusing obedience to or showing disrespect for a referee or official, or behaviour against the spirit of the Rules and likely to bring the game into disrepute.
- 9.13.1** Should this occur during the game, the offending player shall be excluded from the remainder of the game, with substitution after the earliest occurrence referred to in Part Six, Article 9.3, and must leave the competition area.
- 9.13.2** Should the incident occur during any stoppage, during the interval between periods, during a timeout, or after a goal, the player shall be excluded for the remainder of the game and a substitute shall be eligible to re-enter immediately prior to the restart of the game and play will restart in the normal manner.
- 9.13.3** When one or more players of a team persist in repeated fouls other than aggressive play or misconduct or protest referees' or officials' decisions without the use of unacceptable language, the referee may show a yellow card to the offending team. Should the action continue, the referee will issue the offending player of the same team with a red card excluding the player from the remainder of the game according to Part Six, Article 9.13 (misconduct).
- 9.14** To commit a violent action, including kicking, striking, or attempting to kick or strike with malicious intent an opponent or official, whether during actual play, during any stoppages, timeouts, after a goal has been scored or during intervals between periods of play. If the offending player is the goalkeeper, a substitute goalkeeper may be changed for another player in accordance with Part Six, Article 2.6.
- 9.14.1** Should this occur during the game, the offending player shall be excluded from the remainder of the game and must leave the competition area and a penalty throw awarded to the opposing team. The offending player may be substituted when four minutes of actual play have elapsed.





- 9.14.2** Should the incident occur during any stoppage, timeout, after a goal or interval between periods of play, the player shall be excluded from the remainder of the game and must leave the competition area. No penalty throw shall be awarded. The offending player may be substituted when four minutes of actual play have elapsed. Play will restart in the normal manner.
- 9.14.3** If the referees call violent actions simultaneously on players of opposing teams during play, both players are excluded from the remainder of the game with substitution when four minutes of actual play have elapsed. The team, which had possession of the ball, will first shoot a penalty throw followed by the other team shooting a penalty throw. After the second penalty throw, the team, which had possession of the ball, will restart play with a free throw on or behind the half distance line.
- 9.15** In the case of simultaneous exclusion of players of opposing teams during play, both players are excluded for 20 seconds until the earliest occurrence referred to in Part Six, Article 9.3 or at the next change of possession. The possession clock is not reset. Play is restarted with a free throw to the team which had possession of the ball. If neither team had possession when the simultaneous exclusions were called, the possession clock is reset to 30 seconds and play shall be restarted with a neutral throw. Both players excluded under this Rule, shall be permitted to re-enter at the next earliest occurrence referred to in Part Six, Article 9.3 (a)(b) or at the next change of possession.
- 9.16** To interfere with the taking of a penalty throw. The offending player shall be excluded from the remainder of the game with substitution after the earliest occurrence referred to in Part Six, Article 9.3 and the penalty throw shall be maintained or re-taken as appropriate. The referees may use the VAR system to determine if there has been interference with the penalty throw. This offence may occur after the whistle by the referee. See Part Six, Article 15.2.
- 9.17** For the defending goalkeeper to fail to take up the correct position on the goal line at the taking of a penalty throw having been ordered once to do so by the referee. Another defending player may take the position of the goalkeeper but without the goalkeeper's privileges or limitations.
- 9.18** If at the taking of a penalty throw the goalkeeper moves forward before the referee blows the whistle and the player takes the shot and goal is not scored, the goalkeeper shall be excluded according to 9.17 and the penalty throw shall be re-taken.

## **10 PENALTY FOULS**

- 10.1** It shall be a penalty foul to commit any of the following offences (Part Six, Articles 10.2 to 10.12) which shall be punished by the award of a penalty throw to the opposing team. The referee can delay whistling and wait to see if the attacking player scores a goal in the same action. If the player does not score, the referee should sanction the penalty. The referee may raise an arm indicating a possible penalty.
- 10.2** For a goalkeeper or defending player to commit any foul within the 6 metre area if a goal would probably have resulted, including Part Six, Article 10.4 to Part Six, Article 10.7.
- 10.3** For an excluded player intentionally to interfere with play, including affecting the alignment of the goal. If the excluded player does not commence leaving the field of play almost immediately, the referee may deem this to be intentional interference under this Rule.
- 10.4** For a goalkeeper or defending player to pull over, pull down or otherwise displace the goal.
- 10.5** Within the 6 metre area, for a defending player to attempt to block a pass or shot with two hands.
- 10.6** Within the 6 metre area, for a defending player to play the ball with a clenched fist.
- 10.7** Within the 6 metre area, for a goalkeeper or defending player to take the ball under the water when tackled.
- 10.8** For a player or substitute who is not entitled under the Rules to participate in the play at that time to enter the field of play. The penalty throw shall be taken after removing the offending player from the field of play, including by an immediate substitution, if needed.
- 10.9** For the coach, or any team official, of the team not in possession of the ball to request a timeout. No personal foul shall be recorded for this offence.
- 10.10** For the coach or any team official, or player to take any action with intent to prevent a probable goal or to delay the game, including:



- a) a defending player deliberately throwing the ball away before the attacking team can take a free throw
- b) a defending player, after a free throw outside the 6 metre line, deliberately pushing the ball inside 6 metre line, to avoid a direct shot.

No personal foul shall be recorded for this offence by the coach or any team official.

**10.11** For a defending player to impede an attacking player from behind within the 6 metre area when the attacking player is facing the goal and making a shooting action, unless the defending player makes contact only with the ball. If the defending player's foul, described in this Rule, prevents the attacking player from scoring, a penalty must also be called. The referee must delay the call of penalty until the shot or attempted shot is completed and must award a penalty unless the attacking player scores.

**10.12** For an excluded player to re-enter or a substitute to enter the field of play improperly, including not following Part Six, Articles 2.6, 2.7, 9.3, 9.13.1, 9.14.1, 9.14.2, 9.14.3 and 9.15. This player receives only one personal foul, which should be marked by the secretary as a penalty foul.

Should this occur as a (re-)entry from an exclusion with the period of the exclusion not expired, the offending player must leave the field of play before the taking of the penalty throw. The player or a substitute shall be permitted to (re-)enter at the expiration of the period of the exclusion or when the excluded player's team has retaken possession of the ball or is awarded a free throw, a goal throw or a penalty throw except in the circumstances under Part Six, Article 9.14, in which case the player or a substitute shall be permitted to (re-)enter only at the expiration of the period of the exclusion.

## **11 FREE THROWS**

**11.1** A free throw shall be taken at the location of the ball, unless, after a foul committed by a defending player, the ball is inside the goal area. Then the free throw shall be taken on the 2 metre line opposite to the location of the ball. If the ball is outside of the goal area at the moment that the foul is awarded, the free throw shall be taken from the location of the ball.

**11.2** A player awarded a free throw must put the ball into play with no undue delay, including by passing or by shooting, if permitted by the Rules. It shall be an ordinary foul if a player who is clearly in a position most readily to take a free throw does not do so. A defending player having committed a foul shall move away not less than 1 metre from the player taking the free throw before raising an arm to block a pass or shot; a player who fails to do so shall be excluded for "interference" under Part Six, Article 9.5.

**11.3** The free throw shall be taken with no undue delay by the player nearest to the ball in a manner to enable the players to observe the ball visibly leaving the hand of the player taking the throw, who shall also then be permitted to carry or dribble the ball before passing to another player, or to shoot, when permitted. The ball shall be in play immediately when it leaves the hand of the player taking the free throw. However, when there is a counterattack, a player does not have to give up the advantage to go to the ball and take the free throw. The second closest player to the ball can take the throw as long as there is no undue delay.

**11.4** A free throw is also awarded against the team which last touched the ball that went out of the side of the field of play (including the ball rebounding from the side of the field of play) except in the case of a defensive field player blocking a shot over the side of the field of play, in which case a free throw is given to the defensive team.

## **12 GOAL THROWS**

**12.1** A goal throw shall be awarded when the entire ball has passed fully over the goal line excluding between the goal posts and underneath the crossbar, having last been touched by any player other than the goalkeeper of the defending team or when a defending player blocks a shot over the goal line.

**12.2** The goal throw shall be taken according to Part Six, Article 11.3 without undue delay by any player of the team from anywhere within the 2 metre area or where the ball is, if outside 2 metres. A goal throw not taken in accordance with this Rule shall be retaken.

## **13 CORNER THROWS**



- 13.1** A corner throw shall be awarded when the entire ball has passed fully over the goal line excluding between the goal posts and underneath the crossbar, having last been touched by the goalkeeper of the defending team or deliberately by a defending player.
- 13.2** The corner throw shall be taken according to Part Six, Article 11.3 without undue delay by a player of the attacking team from the 2 metre mark on the side nearest to which the ball crossed the goal line. The throw does not need to be taken by the nearest player.
- 13.3** At the taking of a corner throw, no players of the attacking team shall be within the goal area.
- 13.4** A corner throw taken from the wrong position or before the players of the attacking team have left the goal area shall be retaken.

## **14 NEUTRAL THROWS**

- 14.1** A neutral throw shall be awarded when:
- at the start of a period, a referee is of the opinion that the ball has fallen in a position to the definite advantage of one team;
  - one or more players of opposing teams commit an ordinary foul at the same moment which makes it impossible for the referees to distinguish which player offended first;
  - both referees blow their whistles at the same moment to award ordinary fouls to the opposing teams;
  - neither team has possession of the ball and one or more players of opposing teams commit an exclusion foul at the same moment. The neutral throw shall be taken after the offending players have been excluded;
  - the ball strikes or lodges in an overhead obstruction.
- 14.2** At a neutral throw, a referee shall throw the ball into the field of play at approximately the same lateral position as the event occurred in such a manner as to allow the players of both teams to have an equal opportunity to reach the ball. A neutral throw awarded within the goal area shall be taken on the 2 metre line.
- 14.3** If at a neutral throw the referee is of the opinion that the ball has fallen in a position to the definite advantage of one team, the referee shall call for the ball and retake the throw.

## **15 PENALTY THROWS**

- 15.1** A penalty throw shall be taken by any player of the team to which it is awarded from any point on the opponents' 5 metre line.
- 15.2** All players shall leave the 6 metre area and shall be at least three metres from the player taking the throw. On the 6 metre line, on each side of the player taking the throw, one player of the defending team shall have the first right to take position. The defending goalkeeper shall be positioned between the goal posts with no part of the goalkeeper's body beyond the goal line at water level. The referees can give one warning to the players or the goalkeeper to take up the correct position. If that person does not do so, the player or goalkeeper shall be excluded and shall re-enter in accordance with Part Six, Article 9.3.
- 15.3** When the referee controlling the taking of the throw is satisfied that the players are in their correct positions, the referee shall signal for the throw to be taken, by whistle and by simultaneously lowering the arm from a vertical to a horizontal position.
- 15.4** The player taking the penalty throw shall have possession of the ball and shall immediately throw it with an uninterrupted movement directly at the goal. The player may take the throw by lifting the ball from the water or with the ball held in the raised hand and the ball may be taken backwards from the direction of the goal in preparation for the forward throw, provided that the continuity of movement shall not be interrupted before the ball leaves the thrower's hand.
- 15.5** If the ball rebounds from the goal post, crossbar or goalkeeper it remains in play and it shall not be necessary for another player to play or touch the ball before a goal can be scored.



**15.6** If at precisely the same time as the referee awards a penalty throw the timekeeper whistles for the end of a period, all players except the player taking the throw and the defending goalkeeper shall leave the field of play entering the respective flying substitution areas before the penalty throw is taken. In this situation, the ball shall immediately be dead should it rebound into play from the goal post, crossbar or the goalkeeper.

**15.7** If, in the last minute of the game, a penalty throw is awarded to a team, the coach may elect to maintain possession of the ball and be awarded a free throw. The timekeeper recording possession time shall reset the clock to 25 seconds, and the game will be restarted as after a timeout. It is the responsibility of the coach to give a clear signal without delay if the team wishes to maintain possession of the ball in accordance with this Rule.

## **16 PERSONAL FOULS, YELLOW AND RED CARDS**

**16.1** A personal foul shall be recorded against any player who commits an exclusion foul or penalty foul. The referee shall indicate the offending player's cap number to the secretary.

**16.2** Upon receiving a third personal foul, a player shall be excluded from the remainder of the game with substitution after the earliest occurrence referred to in Part Six, Article 9.3. If the third personal foul is a penalty foul, the entry of the substitute shall be immediate. This player must sit in a specific area designated near the bench, if available.

**16.3** The referee, if necessary, must use Yellow and Red Cards to control the Team Officials and Substitute Players on the Team Bench as well as the players in the water. The use of Yellow and Red Cards applies to all World Aquatics Water Polo Competitions and will be administered as follows:

**16.3.1** The issuing of a Yellow Card by the referee is an official warning to the Head Coach of the team.

**16.3.2** The subsequent issuing of a Red Card by the referee is the signal that the Head Coach and/or other Team Official(s) and/or player(s) on the bench must leave pool area immediately. Should the actions of the Head Coach require it, the referee may issue a Red Card, without having issued a Yellow Card.

**16.3.3** When the Head Coach is excluded from the game, another Team Official may replace the Head Coach, however without the privileges of the Head Coach. The Team Official is not allowed to stand and move away from the team bench but can ask for a timeout according to the Rules. During a timeout or after a goal, before the restart of the match, the Team Official may move freely along the side of the pool to the half distance line to instruct the team.

**16.3.4** During the match, when a team member inside the water commits an act of misconduct, the referee must show a Red Card to the player accompanied by the appropriate sanction.

**16.3.5** A referee may issue a Yellow Card, if, in the referee's opinion, a player persists in playing in an unsporting manner or engages in simulation (Part Six, Article 8.14). The referee shall show a Yellow Card to the offending team and point to the offending player. Should the action continue, the referee will show the player a Red Card visible to both the team and the official table as this is deemed to be misconduct (Part Six, Article 9.13).

**16.3.6** Team members committing an act of misconduct will be punished according to Part Six, Article 9.13 and must leave the pool area immediately.

**16.3.7** For any offense potentially leading to a player or team official being excluded from the remainder of a game, the Management Committee of the tournament shall assess all circumstances of the offense, in particular its gravity, and decide whether the player or team official shall be excluded from additional games in the tournament within 24 hours after the end of the game, with notification to the player, team official and team. The Management Committee shall also refer the matter to the Aquatics Integrity Unit if they consider that consequences beyond the tournament should be considered. For the sake of clarity, the Management Committee is entitled to review official video of any match of the tournament to decide whether the player or coach shall be excluded from other games in the tournament, regardless of whether or not the offense was sanctioned by the referee during the match.

If a team official is suspended from a specific match, the team shall have the number of team officials on the bench reduced accordingly; provided that there is at least one (1) team official on the bench.

If a player is suspended from a specific match, the team can have 14 players for the next game(s), provided that they are registered at the team list for the specific World Aquatics event and they don't have any suspension at that moment.



## **17 ACCIDENT, INJURY AND ILLNESS**

**17.1** A player shall only be allowed to leave the water, or sit or stand on the steps or side of the pool during play in the case of accident, injury, illness or with the permission of a referee. A player who has left the water legitimately may re-enter from the team's exclusion re-entry area at an appropriate stoppage, with the permission of a referee.

**17.2** If a player is bleeding, the referee shall immediately order the player out of the water with the immediate entry of a substitute and the game shall continue without interruption. After the bleeding has stopped, the player is permitted to be a substitute in the ordinary course of the game.

**17.3** If accident, injury or illness, other than bleeding, occurs, a referee, at the referee's discretion, may briefly suspend the game ordering the immediate substitution of the injured player, if needed.

**17.4** Should the game be stopped through accident, injury, illness, bleeding or other unforeseen reason, the team in possession of the ball at the time of the stoppage shall put the ball into play at the place of stoppage when the play is resumed.

**17.5** If the referee or VAR assistant referee or delegate, suspects that a violent action may have occurred, the referees may review VAR according to the VAR protocol. (Part Six, Appendix 7).

### **17.6 Medical and Safety specific requirements for Water Polo**

Water Polo is a contact sport. The incidence of traumatic injuries is the highest of the World Aquatics Sport. Therefore, the Medical Team shall be ready to address some specific issues.

#### **17.6.1 Traumatic Injury**

Contact injuries in water polo are high. Therefore, the Chief Medical Officer (CMO) or Venue Medical Officer (VMO) should have the proper medical kit to manage traumatic injuries, which should include suture material and/or skin glue, as a bleeding athlete will not be allowed back in the water (Part Six, Article 17.2).

In addition, ice packs should be available during matches.

Lifeguards and the FoP medical team should be trained in trauma recognition and deep water extractions.

#### **17.6.2 Dental program**

While a dental program is not mandatory at World Aquatics Events, the availability of such medical service should be considered by OC for major competitions.

The objective of a dental program is:

- to provide the treatment required to allow an athlete with an oro-facial injury to return to play as soon as is safe to do so; or
- to treat and stabilise the injury prior to referral.

If there is no venue dentist, a dentist should be identified to be 'on call' for emergency access during the Event.

#### **17.6.3 Water Rescue and Lifeguards**

Lifeguards should practice water retrieval on a daily basis during the event. In Water Polo, it is important to remember that the Field of Play is divided by the lane ropes that could block the access to the player during the water rescue. This point must be taken into consideration while practicing and the extraction point should be adjusted.

## **18 WATER POLO FACILITIES**

### **18.1 General Requirements**

**18.1.1** Water Polo Dimensions and Equipment as detailed in Field of Play diagram. See Water Polo Diagram 1

**18.1.2** The overall Field of Play will be 25.60m x 20.00m. This shall apply to men's and women's matches.

The anchor point at the edge of the Field of Play shall be placed 30cm behind the front of the goal line.

**18.1.3** The depth of the water shall be consistently not less than 1.80 metres.

**18.1.4** The water temperature shall be 26° plus 1° minus 1° Centigrade (25°C-27°C).



**18.1.5** The light intensity shall not be less than 600 lux.

**18.1.6** Minimum Ceiling height is not required.

**18.1.7 Lane Ropes**

Each lane rope will have a minimum diameter of 0.06 metres and a maximum diameter of 0.12 metres.

Lane rope should be secured at each wall to anchor brackets recessed into the walls. If anchor placement is on pool deck, an extender, firm and non-elastic, should be in place. The installed lane rope should stay in the pool water. The anchor, including extender, shall not extend more than 10mm into the pool. The anchor shall not influence the length of the lane rope by more than  $\pm 10$ mm each end of rope. Anchors should be installed to withstand

20kN. The lane rope shall be equipped with a tension spring, absorbing sudden high point loads and a wire withstanding a tensile force of 12kN.

**18.1.8 Flying Substitution Area**

An area for flying substitutions must be available on the lateral outer side of the field of play, on the side where the team benches are situated. The width of this area shall be not less than 0.50 metres.

The designated area for flying substitutions for each team will be between the goal line in front of the team bench and the centre of the field of play.

**18.2 Water Polo facilities for Olympic Games and World Championships**

**18.2.1 General Requirements**

Water Polo Dimensions and Equipment as detailed in Field of Play diagram for Olympic Games and World Championships.

*See Water Polo Diagram, Part Six, Appendix 2*

**18.2.2** The depth of the water shall be consistently not less than 2.00 metres.

**18.2.3** The water temperature shall be 26° plus 1° minus 1° Centigrade (25°C-27°C).

**18.2.4** The light intensity shall not be less than 1500 lux.

**18.2.5** In indoor swimming pools the minimum height of the Field of Play shall be not less than 7.00 metres.

**18.2.6 Lane Ropes**

Each lane rope will have a diameter of 0.10 metres.

Lane rope should be secured at each wall to anchor brackets recessed into the walls. If anchor placement is on pool deck, an extender, firm and non-elastic, should be in place. The installed lane rope should stay in the pool water. The anchor, including extender, shall not extend more than 10mm into the pool. The anchor shall not influence the length of the lane rope by more than  $\pm 10$ mm each end of rope.

Anchors should be installed to withstand 20kN. The lane rope shall be equipped with a tension spring, absorbing sudden high point loads and a wire withstanding a tensile force of 12kN.

**18.2.7 Flying Substitution Area**

An area for flying substitutions must be available on the lateral outer side of the field of play, on the side where the team benches are situated. The width of this area shall be not less than 0.50 metres.

The designated area for flying substitutions for each team will be between the goal line in front of the team bench and the centre of the field of play.

**18.3 Equipment for Water Polo facilities**

**18.3.1 Markings**

Distinctive marks shall be provided on both sides of the field of play to denote the goal lines, lines 2.0 metres and 6.0 metres from that line and half the distance between the goal lines. These markings shall be clearly visible throughout the game.



The white marker shall be measured from the anchor point and will be 0.3 metres to line up with the front of the edge of the goal line. This shall be consistent at both ends of the field.

The 2 metre red marker shall be measured from the front end of the goal line extending into the field of play. This shall be consistent at both ends of the field of play.

The yellow marker shall then extend 4 metre from the 2 metre marker into the field of play. There will be a red marker placed 5 metre from the front end of the goal line. This shall be consistent at both ends of the field of play.

The middle section of the field of play will be green and should be 18 metre for the men's game and 13 metre for the women's game. There will be a white marker placed in the middle of the green area to denote the centre of the field.

The exclusion zones shall be placed in the two corners on the opposite side of the pool to the official table. They shall be 2 metre in length and shall extend along the goal line.

In a water polo field of play, the colour of the lane ropes should follow the above-mentioned colours (also in Appendix 1,2 and 4) , although variations of the colour scheme can be used with the approval of World Aquatics.

### **18.3.2 Referee platforms**

Platforms must be provided on both sides of the field of play, which shall be 1 metre in width and 70 cm in height above the water level. These platforms enable the referees to have free way from end to end of the field of play. Sufficient space shall also be provided at the goal lines for the Goal Judges. The platforms must be colour coded to meet the specification of the lane ropes (see 18.2.7) as shown in the diagram of the field of play. *See Water Polo Diagram, Part Six, Appendix 2*

If the colour scheme of the lane ropes has been changed, the same colour code must be followed on the referee platform.

### **18.3.3 Goals**

The goal posts and crossbar must be of wood, metal or synthetic (plastic) with rectangular sections of 80,0 millimetres, square with the goal line and painted white.

The goal posts must be fixed, rigid and perpendicular at each end of the playing space, equal distances from the sides and at least 0.3 metre in front

of the ends of the field of play or of any obstruction. Any standing or resting place for the goalkeeper other than the floor of the pool is not permitted.

The inner sides of the goal posts must be 3.0 metre apart.

The underside of the cross bar must be 0.9 metre above the water surface.

### **18.3.4 Re-entry area**

The rectangular excluded players' re-entry area shall have the following dimensions: 2.0 metres by 1.08 metre.

### **18.3.5 Nets**

Limp nets must be attached to the goal fixtures to enclose the entire goal space securely fastened to the goal posts and crossbar, allowing not less than 0.3m of clear space behind the goal line everywhere within the goal area.

### **18.3.6 Secretariat table**

The game secretariat shall be placed at a table behind the referees and at the same.

## **19 BEACH WATER POLO RULES**

### **19.1 Field of Play**

**19.1.1** The distance between the goal line at each end of the field of play shall be fifteen (15) metres.

The width of field of play shall be 10.0 – 12.5 metres.

**19.1.2** The depth of the water of the playing area must not be less than two (2) metres.



- 19.1.3** Distinctive buoys shall be provided on both sides of the playing area:  
Two (2) metre area red buoys.  
Five (5) metre area yellow buoys remainder of the playing area green buoys.  
Half distance line white buoys.
- 19.1.4** Red buoys shall be placed at each end, two (2) metres from the corner of the playing area on the side of opposite to the official table to denote the touching corner.
- 19.1.5** The boundary of the field of play at each end shall be in line with the front of the goalpost.
- 19.1.6** The secretary shall be provided with separate white, blue, red, and yellow flags, each measuring 0.35 metres x 0.20 metres.
- 19.1.7** An area for flying substitutions must be available on the lateral outer side of the field of play, on the side where the team benches are situated. The width of this area, if segregated by lane ropes, must be between 0.5 metres – 1 metre. The designated area for flying substitutions for each team will be between the goal line in front of the team bench and the centre of the field of play.
- 19.1.8** The BWP Goal Area is defined by the space between the goal posts, extending out to the 2-metre line. (See rules 19.16.1, 19.17.3h and 19.19.2).
- 19.2** **Goalposts**
- 19.2.1** Two goalposts and crossbar rigidly constructed, rectangular with a dimension of 0.080 metres facing to the field of play and painted in any colour. The goals shall be located on the goal lines at each of the field of play end and equal distances from the sides. While rigidly constructed posts are preferred for World Aquatics events, inflatable posts are allowed for local tournaments.
- 19.2.2** The inner sides of the goal posts shall be 2.5 metres and the crossbar shall be 0.80 metres from the surface of the water.
- 19.2.3** The limp nets shall be securely fastened to the goal posts to prevent the ball from going underneath or through the side of net. The depth of the goals shall not be less than 0.30 metres.
- 19.3** **The Ball**
- 19.3.1** The ball shall be round and shall have an air chamber with a self- closing valve. It shall be waterproof without external strapping or any covering of grease or similar substance.
- 19.3.2** The weight of the ball shall be not less than 400 grammes and not more than 450 grammes.
- 19.3.3** For the games played by men, the circumference of the ball shall be not less than 0.68 metres and not more than 0.71 metres, and its pressure shall be 7.5-8.5 pounds per square inch atmospheric.
- 19.3.4** For games play by women, the circumference of the ball shall be not less than 0.65 metres and not more than 0.67 metres, and pressure shall be 6.5-7.5 pounds per square inch atmospheric.
- 19.4** **Caps**
- 19.4.1** Caps shall be of contrasting colours other than solid red, as approved by the referee, but also to contrast with the colour of the ball. A team may be required by the referee to wear white or blue caps. The goalkeepers shall wear red caps. Caps shall be fastened under the chin. Caps shall be fitted with malleable ear protectors which shall be the same colour as the team's caps except that the goalkeeper may have red ear protectors.
- 19.4.2** Caps shall be numbered on both sides with 0.10 metres in height. The goalkeeper shall wear cap number one (1) and the other caps shall be numbered two (2) to seven (7).
- 19.4.3** A player who substitutes for the goalkeeper shall wear a red cap with the same number as he/she was wearing as a field player. A player shall not be allowed to change cap number during the game except with the permission of the referee and after notifying the secretary. Caps shall be worn throughout the entire game. If a player loses the cap during play, the player shall replace it at the next appropriate stoppage of the game when the player's team is in possession of the ball. The substituted goalkeeper shall wear cap No.1 with the same colour of his/her team. Teams shall supply a set of red caps numbered 1-7, as well as a cap numbered one (1) in the same colour of his/her team.





**19.4.4** For international games, the caps shall display the international three letter country code on the front and may display the national flag.

**19.5 Teams and Substitutes**

**19.5.1** Each team shall consist of four players, one of whom shall be the goalkeeper, and not more than three reserves who may be used as substitutes.

**19.5.2** Two (2) officials namely the head coach or another official (Assistant Coach or Team Manager) are permitted to sit on the pontoon or similar designated area and shall not move away from there during the game. Up to two (2) other medical staff are permitted at a separate location away from the team bench.

**19.5.3** Teams shall change ends at half time.

**19.5.4** The substitutes' benches in beach water polo can be a pontoon and must be placed on the opposite side of the field of play from the referee and match officials.

**19.5.5** Each team shall have a captain who shall be responsible for the behaviour of the team.

**19.5.6** Players have to present themselves for matches with fingernails properly cut and shall remove any articles that are likely to cause injury.

Players shall not have grease, oil or any similar or foreign substance on the body or hands. If the referee ascertains before the start of play that such a substance has been used, they shall order it to be removed immediately. If the offence is detected after the play has started, the offending player shall be excluded for remainder of the game with immediate substitution.

**19.5.7** Each team shall have three substitutes who may participate in the game substituting a player. A substitute may enter the game from the touching corner as soon as the exiting player has visibly risen to the surface of the water in the touching corner and touched hands above the water with the substitute outside of the field of play. Substitution from the designated flying substitution area is allowed when the substitute enters the area from behind the extended goal line, both players, the exiting player, and the substitute, are in the water, outside of the field of play and touch hands above the water.

**19.5.8** A goalkeeper who has been replaced by a substitute may play in any position.

**19.5.9** After a goal, substitutions may be made from either the touching corner or flying substitution area after the goalkeeper has put the ball back into play. When substituting, both players need to be outside the field of play and make a visible high hand touch between the substituting players before entering the field of play.

**19.5.10** The goalkeeper may touch the ball with two (2) hands inside the team's five (5) metre area.

**19.5.11** No substitution is allowed when a penalty foul is called, and before the penalty throw is taken.

**19.6 Officials**

**19.6.1** In all official competitions the match officials shall be as follows:

- one referee
- two secretaries
- two timekeepers

**19.6.2** The duties of the secretaries shall be:

- to maintain the record of the game, including the players, the score, time outs, exclusion fouls and penalty fouls awarded against each player.
- to signal with the red flag and whistle for any improper re-entry of an excluded player or substitute.
- after three (3) minutes, the secretary should signal the re-entry of a substitute for a player who has committed brutality by raising the yellow flag along with the appropriate coloured flag.
- to keep track of personal fouls, team fouls, and to indicate when a bonus penalty foul is called by a suitable audible signal (e.g., whistle or electronic signal). To record the time and the player's cap number when a goalkeeper is substituted.
- to control the 'Alternating Possession System' for awarding free throws for neutral throw situations. (19.15.1).

**19.6.3** The duties of the timekeeper shall be:

- to record the exact periods of actual play, time outs and the intervals between the periods.
- to record the periods of continuous possession of the ball by each team.



- to announce the start of the last minute of the game.
- to signal by whistle after 45 seconds and at the end of each time out.

**19.6.4** A timekeeper shall signal by whistling (acoustically efficient and readily understood) the end of each period independently of the referee and the signal shall take immediate effect and stop the game except:

- in the case of the simultaneous award by the referee of a penalty throw, in which event the penalty throw shall be taken.
- if the ball is in flight and crosses the goal line, in which event any resulting goal shall be allowed.

## **19.7 Referee**

**19.7.1** The referee has absolute jurisdiction over the game, from the time the teams enter the playing area until they leave. All decisions are final and have to be accepted by all players and coaches. The referee may alter a decision, as long as this is done before the ball is back in play.

**19.7.2** The referee shall whistle to start the game and to declare goals, goal throws, corner throws, neutral throws, and infringements of the rules.

**19.7.3** The referee can apply the advantage rule so as not to favour the team that has committed the offence and should not stop play unless it is absolutely necessary.

**19.7.4** The referee has the power to order any player from the water in accordance with the rules. If a player refuses to obey the referee's instructions, the match shall be abandoned and the game awarded five (5) goals to zero (0) to the opposing team.

**19.7.5** The referee shall have the power to order the removal from the precincts of the pool any player, substitute, spectator or official whose behaviour prevents the referee from carrying out their duties in an impartial manner.

**19.7.6** The referee shall have the power to abandon the game at any time if the referee believes that behaviour of players or spectators, or any other circumstances, prevent the match from taking place in a fair and correct manner. If the game has to be abandoned, the referee shall report their actions to the competent authority.

## **19.8 Duration of the Game**

**19.8.1** The duration of the game shall be four (4) periods of five (5) minutes each of actual play. Time shall commence at the start of each period when a player touches the ball. At all signals for stoppages, the recording watch shall be stopped until the ball is put back into play by the ball leaving the hand of the player taking the appropriate throw or when the ball is touched by a player following a neutral throw.

**19.8.2** There shall be a two (2) minute interval between the 1st/2nd & 3rd/4th periods, and a three (3) minute interval at half time. The teams, including the players, coaches and officials, shall change ends at half time (Part Six, Article 19.5.3).

**19.8.3** Every game that is drawn at the end of the four periods of play will be decided by conducting a penalty shoot-out in the same manner as the Water Polo Rules. The goalkeeper can be one of the shooters. The goalkeeper can be substituted only when the goalkeeper is excluded from the remainder of the game for misconduct, violent action, or injury. Immediately after the goalkeeper is excluded, the substitute goalkeeper cannot have the goalkeeper's privileges for the first penalty throw taken after the offence.

The three players nominated will required to be listed in order and that order will determine the sequence, which cannot be changed.

No players excluded for remainder of the game are eligible to be listed among those players to shoot.

Shots will be taken alternately at either end of the pool, unless conditions at one end of the field of play advantage or disadvantage a team, in which case all shots may be taken at the same end. All players taking the shots will remain in the water in front of their pontoon and the other players will be required to be seated on the team's pontoon. If the goalkeeper is excluded during the penalty shoot-out, a player from the nominated three players may substitute for the goalkeeper but without the privileges of the goalkeeper.

Following the taking of the penalty shot, the player may be substituted by another player or goalkeeper. If a field player is excluded during the penalty shoot-out, the player's position is removed from the list of the three players participating in the penalty shoot-out, and a substitute player is placed in the last position of the list.

The team to shoot first will be determined by the toss of a coin.



Should teams still be tied following the completion of the initial three penalty shots, the same three players shall then take alternate shots until one team misses and the other scores.

**19.8.4** Any visible clock shall show the time in descending manner.

**19.8.5** If a game (or part of a game) must be replayed, then goals, personal fouls and time outs that occurred during the time to be replayed are deleted from the game score sheet, however brutality, misconduct, and any red card exclusions are recorded on the game score sheet.

**19.8.6** (Mercy Rule) After half time, if the goal difference between the two team is 10 or more, the game will be declared finished and the leading team the winner.

#### **19.9 Time outs**

**19.9.1** Each team may request two timeouts per game.

**19.9.2** A time out may be requested at any time by the coach of the team in possession of the ball except when a penalty foul is called. The coach shall call "time out" and signal to the referee or secretary with hands forming a T- shape. If a time out is requested, the secretary or referee shall immediately stop the game by whistle and players shall return to their respective halves of the field of play.

**19.9.3** Play shall be restarted upon the whistle of the referee by the team in possession of the ball putting the ball into play on or behind the half distance line.

**19.9.4** The possession clock continues from the recommencement of play after the time out.

**19.9.5** If the coach in the possession of the ball requests an additional time out to which the team is not entitled, the game shall be stopped and play shall then be restarted by a player of opposing team putting the ball into play at the half distance line.

If the coach of the team not in possession of the ball requests a time out, the game shall be stopped and a penalty throw awarded to the opposing team.

#### **19.10 The Start of Play**

**19.10.1** The first team listed in the official program will wear white or light colour caps, or the caps reflecting the colour of their country and will start the game to the left of the official table. The other team will wear blue or dark colour caps, or caps of a contrasting colour and will start the game to the right of the official table.

**19.10.2** At the start of each period, both teams will line up on their side of the playing area. When the referee is satisfied both teams are ready the referee shall blow the whistle to start and then throw the ball into play on the half distance line.

**19.10.3** If the ball is thrown giving one team a definite advantage, the referee shall call for the ball and award a neutral throw on the half distance line.

#### **19.11 Scoring**

**19.11.1** A goal shall be scored when the entire ball has passed fully over the goal line, between the goal posts and underneath the crossbar.

**19.11.2** A goal can be scored with any part of the body except the clenched fist.

**19.11.3** A goal can be scored from inside five (5) metres only if two players from either team intentionally play or touch the ball after the start of play.

**19.11.4** A goal may be scored by a player by a shot from a free throw awarded and taken outside the five (5) metre area after fake or dribble or putting the ball on the water.

*[Note: when the player is not shooting directly, the ball must be put in play as described in the rules before faking and dribbling]*

**19.11.5** A goal may be scored by a player after visibly putting the ball in play outside of five (5) metre line when the foul is called outside of five (5) metre line, goal throw (either directly or after putting the ball in play), or a free throw thrown by a player into the player's own goal.

**19.11.6** A goal shall be scored if, at the expiration of twenty (20) seconds possession or at the end of a period, the ball is in flight and enters the goal.

**19.12 Restarting after a goal**

**19.12.1** The goalkeeper shall put the ball into play from the two (2) metre line or behind immediately after a goal has been scored. The timekeeper shall stop the game clock after a goal is scored, and will restart it when the ball is put into play for restart.

**19.13 Goal Throw**

**19.13.1** A goal throw shall be awarded when the entire ball has passed fully over the goal line excluding between the goal posts and underneath the crossbar, having last been touched by any player.

**19.13.2** The goal throw shall be taken by any player of the team from anywhere within the 2metre area.

**19.14 Corner Throw**

**19.14.1** No corner throws shall be applied in Beach Water Polo.

**19.15 Neutral Throw**

No neutral throws shall be taken, and if neutral throw situation occurs, "The Alternating Possession System" shall be applied in the following way:

The team that wins the swim-up of the first period loses the first neutral throw.

For subsequent neutral throw situations, free throws shall be awarded to the teams alternately. The team entitled to the next free throw shall be indicated by the alternating possession arrow in the direction of the opponent's goal. The direction of the alternating possession arrow shall be reversed immediately when the alternating possession free throw is taken.

**19.16 Free Throw**

**19.16.1** A free throw shall indicate that a foul has been committed. The free throw shall be taken from the location of the ball, except a) if the foul is committed by a defending player within the defender's BWP Goal Area, the free throw shall be taken on the two (2) metre line opposite to where the foul was committed and b) where otherwise provided for in the Rules.

**19.16.2** The free throw shall be taken from the location of the ball by the player of the team who is the nearest to the ball. When there is a counter attack, a player with advantage does not have to give up the advantage to go to the ball and take the free throw or goal throw. Another player of that team can take the throw as long as there is no undue delay.

**19.16.3** The free throw must be taken in such a manner so as to enable all the other players to see that the throw has been taken. The player can either throw the ball up into the air or let it fall on to the water.

**19.16.4** The time allowed for a player to take a free throw shall be at the discretion of the referee. It shall be reasonable and without undue delay but does not have to be immediate. It shall be an offence if a player who is clearly in a position most readily to take a free throw does not do so.

**19.17 Ordinary Fouls**

**19.17.1** The penalty for an ordinary foul shall be a free throw awarded to the opposing team.

**19.17.2** The referee must award ordinary fouls in accordance with the rules to enable the attacking team to develop an advantage situation.

**19.17.3** It shall be an ordinary foul to commit any of the following offences:

- a) to start the swim off before the referee's whistle is blown;
- b) to assist or push a player at the start of a period or at any time during the game;
- c) to hold on or push off equipment or structures around the field of play or the goal posts;
- d) To take or hold the entire ball under the water when tackled, or to deliberately hide it from the opposing team
- e) to touch the ball with two hands at the same time, except for the goalkeeper within the team's own five (5) metre area;
- f) to push or push off from an opponent who is not holding the ball;



- g) for another member of the team in whose favor a free throw has been awarded to commit another ordinary foul before the free throw is taken;
- h) during the game, players are free to take up any position in the field of play with the exception that no attacking player may enter the space between the goal posts and closer than two (2) metres from the goal line, with or without the ball (the BWP Goal Area).
- i) to take a penalty throw not in accordance with the manner prescribed in Part Six, Article 19.20.5.
- j) to send the ball over the buoys delineating the sides of the field of play (the ball remains in play if it just touches the sides of the field of play);
- k) for a goalkeeper to touch the ball with two hands at the same time outside the goalkeeper's five (5) metre area;
- l) for a team to retain possession of the ball for more than twenty (20) seconds of actual play without shooting at their opponent's goal. The timekeeper recording the possession time shall reset the clock: when the ball has left the hand of the player shooting at goal. If the ball rebounds into play from the goal, crossbar or the goalkeeper, the possession time shall not:
  - m) restart until the ball comes into the possession of one of the teams;
  - n) when the ball comes into the possession of the opposing team. Possession shall not include merely being touched in flight by an opposing player;
  - o) when the ball is put into play following the award of an exclusion foul, penalty foul, goal throw, corner throw or neutral throw;
  - p) Visible clocks shall show the time in a descending manner (show the possession time remaining).
  - q) To simulate being fouled. [NOTE: Simulation means an action taken by a player with the apparent intent of causing a referee to award a foul incorrectly against an opposing player. A referee may issue a yellow card against a team for repeated simulation and may apply Part Six, Article 9.13 (persistent fouling) to sanction offending players.]
  - r) To go under the water to gain positional advantage.

## **19.18 Exclusion Fouls**

**19.18.1** It shall be an exclusion foul to commit any of the following offences which shall be punished (except in the case of penalty throw) by the award of a free throw to the opposing team. The excluded player shall touch that part of the goal line indicated by red buoy and re-join play immediately. A penalty will be awarded against the team of that player who, when leaving the playing area after being excluded, interferes with play. The excluded player may be substituted by leaving the field of play at that part of the goal line indicated by the red buoy (the touching corner). The substitute may enter the field of play from the touching corner as soon as the player has visibly risen to the surface of the water within the touching corner area and touched hands above the water with the substitute.

**19.18.2** For a player to leave the water during play, except in the case of accident, and injury, or with the permission of the referee.

**19.18.3** To interfere with the taking of a free throw or goal throw intentionally pushing the ball away to delay the throw any attempt to play the ball before it leaves the hand of the player taking the throw.

**19.18.4** To intentionally splash water in the face of an opponent outside the five (5) metre line. The punishment for intentionally splashing an opponent is exclusion under 19.18.1

**19.18.5** To hold, sink or pull back an opponent who is not holding the ball.

**19.18.6** To impede an opponent's movement who is not in possession of the ball.

**19.18.7** To kick or strike an opponent intentionally or make disproportionate movement with that intent.

**19.18.8** Upon a change of possession, for a defending player to commit a foul on any player of the team in possession of the ball with the intent to stop the flow of the attack, anywhere in the field of play. This kind of foul is called a tactical foul.



- 19.18.9** To be guilty of misconduct, including the use of unacceptable language, violent or persistent foul play, to refuse obedience or show disrespect to the referee or official, or behaviour against the spirit of the rules and likely to bring the game into disrepute. While substitution for a player who has been excluded from the remainder of the game due to misconduct can be made immediately in BWP rules, the player who has been excluded from the remainder of the game due to misconduct will have to leave the field of play from the touching corner first, and then the substitute can enter the field of play immediately thereafter.
- 19.18.10** To commit a violent action against an opponent or official, during the game. The offending player shall be excluded from the remainder of the game with substitution after three (3) minutes and a penalty throw awarded to the opposing team.
- No penalty throw shall be awarded against a violent action committed during an interval or stoppage.
- 19.18.11** For an excluded player to re-enter or a substitute to enter the playing area improperly, including: from any place other than the player's own re-entry area by affecting the alignment of the goal entering the field of play before the player who is being substituted leaves the field of play
- 19.18.12** To interfere with the taking of a penalty throw, in which case the player excluded can only re-enter the field of play after the penalty throw has been taken. Players have to be at least three (3) metres away from the player taking the penalty throw.
- 19.18.13** The defending goalkeeper, after having been warned by the referee, for not positioning correctly on the goal line before the taking of a penalty throw. Another defending player may take the position of the goalkeeper but without the privileges of the goalkeeper.
- A goalkeeper who is excluded before a penalty throw, cannot return to the field of play immediately after touching the corner area, but has to leave the field of play and wait in the touching corner. The goalkeeper shall be able to return to play only after the penalty shot has been taken, which means the ball is released from the thrower's hand.
- 19.18.14** If two players from opposing sides commit simultaneous exclusion fouls, both players will be excluded. The ball possession will be maintained, and the attacking team shall restart the game with a free throw. Possession time shall be maintained and shall not be reset.
- The game will restart when both of the excluded players have returned to their touching corners. Both players or substitutes will then be allowed to return to the field of play upon a change of the possession, or after a goal. If the excluded players are substituted, substitutions have to be made outside of field of play at the touching corner after touching hands with the both players.
- 19.18.15** A player who has committed five (5) personal fouls shall be excluded from the remainder of the game.
- 19.19** **Penalty Fouls**
- 19.19.1** It shall be a penalty foul to commit any of the following offences which shall be punished by award of a penalty throw to the opposing team. The referee will indicate that a penalty throw has been awarded by blowing the whistle and raising the arm with five fingers. The referee must delay the call of penalty until the shot or attempted shot is completed. In such case, the referee may raise his/her arm indicating a possible penalty.
- 19.19.2** For a defending player to commit any foul within the five (5) metre area but for which a goal would probably have resulted, including: sink or displace the goals for a defending player to play the ball with clenched fist for the goalkeeper or another player to take the ball under the water when tackled within 5m area but outside the BWP Goal Area to splash in the face of an opponent intentionally who is inside the five (5) metre area and is attempting to shoot at goal.
- 19.19.3** For a defending player within the 5-metre area to kick or strike an opponent or to commit a violent action. In the case of a violent action, the offending player shall also be excluded from the remainder of the game with substitution after three (3) minutes.
- 19.19.4** For an excluded player intentionally to interfere with play, including affecting the alignment of the goal.
- 19.19.5** For a player or substitute who is not entitled under the Rules to participate in the play at that time to enter the field of play. The offending player shall also be excluded from the remainder of the game with substitution.
- 19.19.6** For the coach, any team official, or player to take any action with intent to prevent a probable goal or to delay the game, including:



- If a defending player deliberately throws the ball away before the attacking team can take a free throw
- If a defending player, after a free throw outside the five (5) metre line, deliberately pushes the ball inside five (5) metre line, to avoid a direct shot.

No personal foul shall be recorded for this offence for the coach or any team official.

**19.19.7** For a player or substitute, of the team not in possession of the ball, to enter the field of play improperly.

**19.19.8** If, in the last minute of the game a penalty throw is awarded to a team, the coach may elect to maintain possession of the ball and be awarded a free throw. The timekeeper recording possession time shall reset the clock.

**19.19.9** Inside the 5 metre area, when a player, in a "probable goal situation", is swimming with and/or is holding the ball and is impeded (attacked) from behind during an attempt to shoot, a penalty foul must be awarded. [Note: unless only the ball is touched by the defender]

**19.19.10** Bonus penalty throws shall be awarded at every 4th personal foul (Team Fouls) per period. At the fourth personal foul per team in a period, a bonus penalty throw shall be awarded to the other team, and the player who has committed the foul shall move to touching corner of the player's team outside the field of play until the penalty throw is taken. In this case, no substitution shall be allowed before the penalty throw is taken. If the 4th personal foul is a penalty foul, only 1 penalty throw shall be awarded to the other team. If the penalty throw results in a goal, the team who has taken the penalty throw shall be allowed to have a new consecutive possession of the ball starting in the same manner as restart after a timeout (19.9.3). If the penalty throw does not result in a goal, the play shall continue.

#### **19.20 Penalty Throws**

**19.20.1** A penalty throw can be taken by any player of the team in favour of which the throw has been awarded. The penalty throw is taken from the five (5) metre line.

**19.20.2** The defending goalkeeper shall be positioned between the goalposts with no part of the body beyond the goal line at water level.

**19.20.3** All players except the player who has committed the penalty foul shall leave the five (5) metre area and shall be at least three (3) metres from the player taking the penalty throw. A player who has committed a penalty foul shall move to their team's touching corner inside of the field of play until the penalty throw is taken.

**19.20.4** The referee, after seeing that all the players are in correct position, will order the taking of the penalty throw in the following manner: The raised arm will mean ready to shoot and by bringing the referee's arm from vertical to horizontal position and blowing the whistle simultaneously. The lowering of the arm at the same time as the signal by whistle makes it possible under any conditions to execute the penalty throw in accordance with the rules.

**19.20.5** The player taking the penalty throw shall have possession of the ball and shall immediately throw it with an uninterrupted movement directly at the goal. The player may take the throw by lifting the ball from the water or with the ball held in the raised hand and the ball may be taken backwards from the direction of the goal in preparation for the forward throw, provided that the continuity of movement shall not be interrupted before the ball leaves the thrower's hand.

**19.20.6** If the ball rebounds from the goalpost crossbar or goalkeeper, it remains in play and it shall not be necessary for another player to play or touch the ball before a goal can be scored.

**19.20.7** If, at precisely the same time as the referee awards a penalty throw, the timekeeper whistles for the end of a period, all players except the player taking the penalty throw and the defending goalkeeper shall leave the water before the penalty throw is taken. In this situation, the ball shall immediately be dead should it rebound into the field of play.

#### **19.21 Accident and Injury**

**19.21.1** A player shall only be allowed to leave the water during play in the case of accident or injury or with the permission of the referee. A player who has left the water legitimately may re-enter from the re-entry area nearest the player's own goal line at an appropriate stoppage and with the permission of the referee.

**19.21.2** If a player is bleeding, the referee shall immediately order the player out of the water with the immediate entry of a substitute. After the bleeding has stopped, the player is permitted to be a substitute in the ordinary course of the game.



**19.21.3** If accident or injury, other than bleeding, occurs, the referee, at the referee's discretion, may suspend the game for not more than three minutes, in which case the referee shall instruct the timekeeper as to when the stoppage period is to commence. Except in the circumstances of Part Six, Article 19.21.2 (bleeding), the player shall not be allowed to take further part in the game if a substitute has entered.

**19.22 Personal Fouls**

**19.22.1** A personal foul shall be recorded against any player who commits an exclusion foul or penalty foul. The referee shall indicate the offending player's cap number to the secretary.

**19.22.2** Upon receiving a fifth (5th) personal foul, a player shall be excluded from the remainder of the game with substitution after he/she reaches the touching corner outside of the field of play, having touched hands with each other.

**19.22.3** When a team accumulates four (4) personal fouls in any period of a game, a penalty throw shall be awarded, and the accumulated Team Fouls shall then be cancelled and recounted (as stipulated in Part Six, Article 19.19.10).

**19.23 Yellow and Red Cards**

**19.23.1** The referee, if necessary, must use Yellow and Red Cards to control the Team Officials and Substitute Players on the Team Bench as well as the players in the water. The use of Yellow and Red Cards applies to all World Aquatics Water Polo Competitions and will be administered as follows;

The issuing of a Yellow Card by the referee is an official warning to the Head Coach of the team.

The subsequent issuing of a Red Card by the referee is the signal that the Head Coach and/or other Team Official(s) and/or player(s) on the bench must leave the pool area immediately. Should the actions of the Head Coach require it, the referee may issue a Red Card, without having issued a Yellow Card.

When the Head Coach is excluded from the game, another Team Official may take this position, however without the privileges of the Head Coach. The Team Official is not allowed to stand and move away from the team bench but can ask for a time-out according to the rules. During a time out or after a goal, before the restart of the match the Team Official may move freely along the poolside till the halfway mark to instruct the team.

During the match, when a team member inside the water commits an act of misconduct, the referee must show a Red Card to the player accompanied by the appropriate sanction.

A referee may issue a Yellow Card, if, in the referee's opinion, a player persists in playing in an unsporting manner or engages in simulation. (Part Six, Article 8.14). The referee shall show a Yellow Card to the offending team and point to the offending player. Should the action continue, the referee will show the player a Red Card visible to both the team and the table as this is deemed to be misconduct. (as per Part Six, Article.9.13)

Team members committing an act of misconduct will be punished according to Part Six, Article 9.13 and must leave the pool area immediately.





## **20 APPENDICES**

The following appendices are incorporated in and form part of these Rules, Part Six:

- 20.1 APPENDIX 1 - DIAGRAMS
- 20.2 APPENDIX 2 - DIAGRAMS
- 20.3 APPENDIX 3 - DEFINITIONS
- 20.4 APPENDIX 4 - FIELD OF PLAY & EQUIPMENT
- 20.5 APPENDIX 5 - OFFICIALS
- 20.6 APPENDIX 6 - PENALTY SHOOT OUT
- 20.7 APPENDIX 7 - VAR PROTOCOL
- 20.8 APPENDIX 8 - AGE GROUP TOURNAMENTS
- 20.9 APPENDIX 9 - TOURNAMENT STRUCTURE
- 20.10 APPENDIX 10 - PROTOCOL FOR COACH'S CHALLENGE



**20.1 APPENDIX 1 - DIAGRAMS**

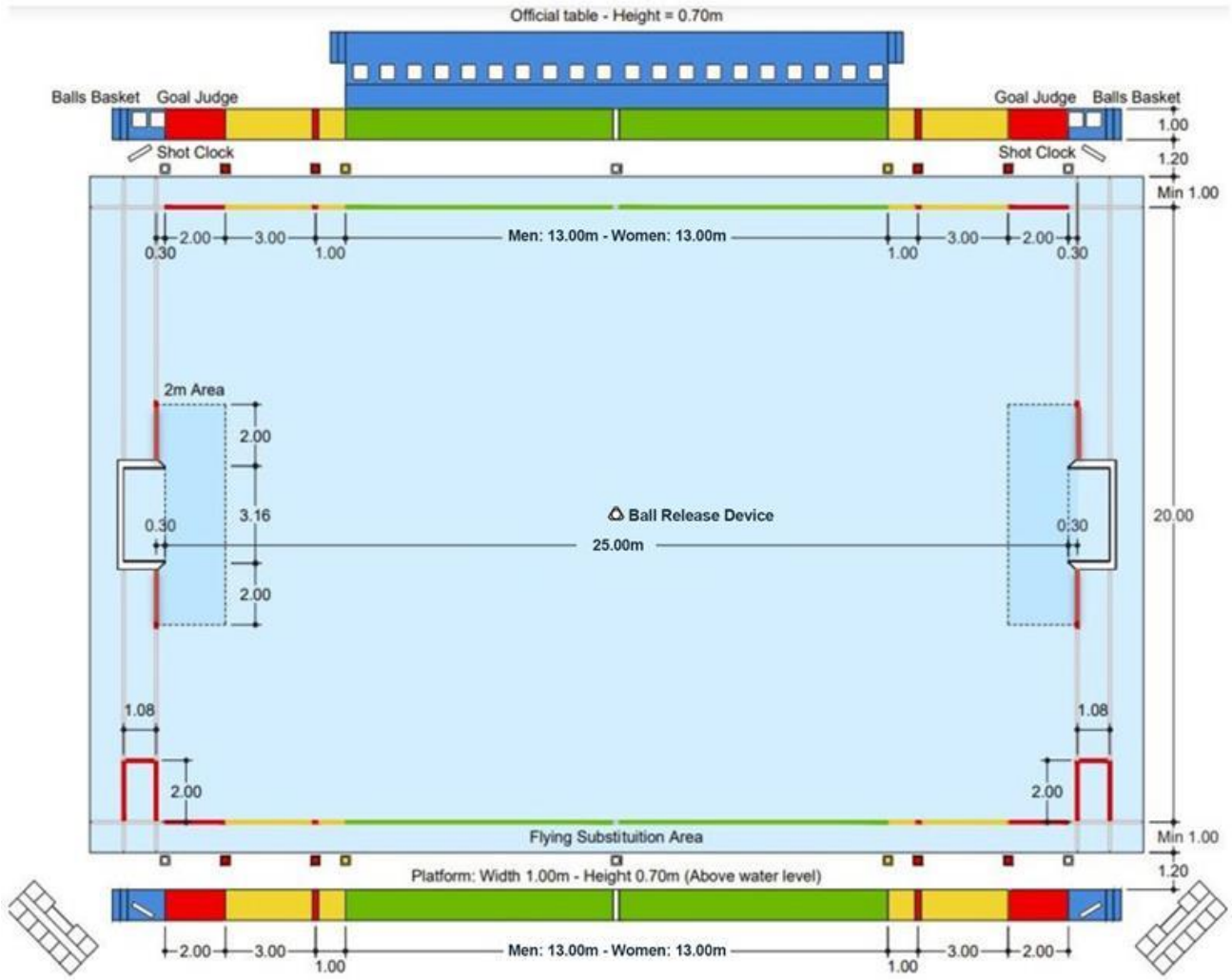



**20.2 APPENDIX 2 - DIAGRAMS**

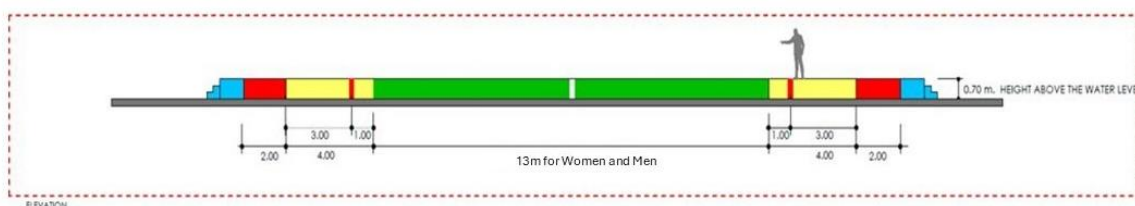
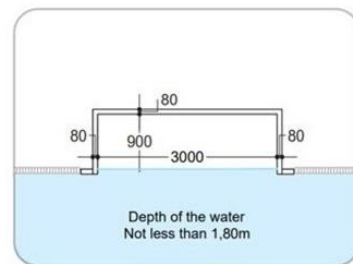
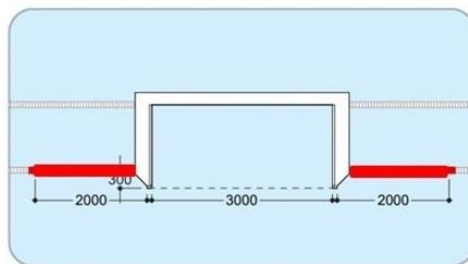
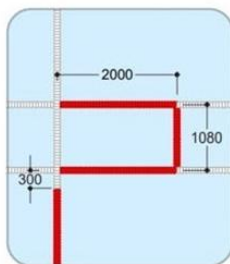
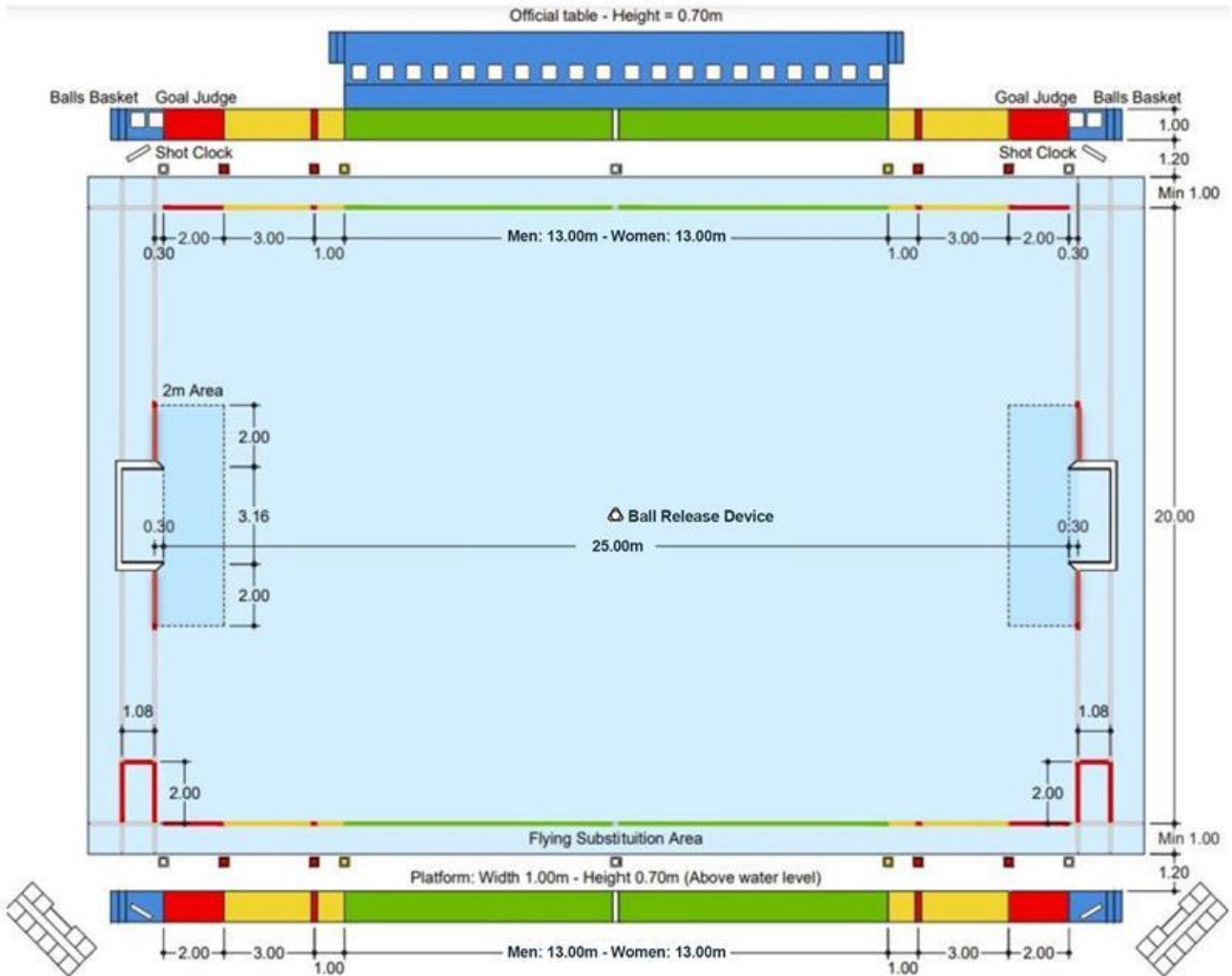



## FIELD OF PLAY & EQUIPMENT

**Field of Play:** The part of the water officially marked as the place for the action of a water polo game as described in Appendix 4.

**Official table:** The designated location where other necessary officials and authorized persons carry out their responsibilities during a game.

**Flying Substitution:** The ability of a team to exchange players during play from the flying substitution area.

**Flying Substitution Area:** The area designated by the Rules at the side of the Field of Play where flying substitutions may occur.

**Goal (definition A):** The result of the ball fully crossing the goal line past the front line of the goal posts and underneath the crossbar.

**Goal line:** the end of the field of play, formed by the front face of the goal post (VI 7.1)

**Goal area:** Is a rectangular box extending 2 metres from the lateral outsides of the goal posts to the 2 metre line opposite the goal line. In this area, attacking players must not enter without possession of the ball, unless they are behind the line of the ball.

**5 metre line:** Is the line, from where penalty throw should be taken.

**6 metre area:** is an area within 6 metres of the goal line where some fouls become a penalty foul, according to the penalty rules.

**Half distance line:** Line which divides the length of the field of play into two equal halves at its midpoint.

**Goal:** The structure into which the ball must fully enter in order to score. (Appendix 4.2)

## TEAMS AND SUBSTITUTES

**Team:** team of water polo players as described in Part Six, Article 2.1.

**Player:** an individual member of a water polo team.

**Goalkeeper:** individual member of a team, wearing a red cap 1, whose main role is to prevent the ball from entering the goal. A substitute goalkeeper shall wear any cap from 2 to 14, which must be a red cap. In case of a third goalkeeper nominated to a specific tournament where 15 players or more players are allowed on the team roster, cap number 15 should be red and dedicated for the 3<sup>rd</sup> goalkeeper,

**Substitute:** A player entering the field to replace a player already in the field of play or an excluded player.

**Reserve:** A team member who is not playing at the time.

**Designated lateral substitution area:** is “Area for Flying Substitutions”

**Exclusion Re-entry area:** Location from where a player or substitute returns to the field of play after an exclusion.

**Advantage:** The opportunity of an attacking player and/ or the attacking team to continue to play the ball in order to generate an opportunity to score. Referees must officiate such that the attacking team can maintain its advantage.

**Red Card:** Signal from the referee to indicate an exclusion from the remainder of the game to a player, coach or any team official.

**Yellow Card:** Warning signal from the referee to the coach for inappropriate behaviour or insufficient bench sport, or for repeated simulation and persistent foul play of a team.

**Offending player:** A player committing a foul according to the rules.



## REFEREES AND TECHNICAL OFFICIALS

**Video assistant referee – VAR:** Video technology and assistant referee, which the referee may use to make a final decision after reviewing a situation in described situations in Appendix 7 – VAR protocol or after a challenge by the coach in the circumstances in Appendix.10 – Challenge Protocol.

**Referee:** An official responsible for conducting the game with designated functions fixed by the Rules.

**Possibility to play the ball:** When the player in possession of the ball is able to continue playing by putting the ball into action.

**Centre forward:** An attacking player whose primary position is near the opponent's 2 metre line and generally between the width of the goal posts.

**Centre back:** A defender whose primary responsibility is to mark the attacking centre forward. (See Centre Forward)

**Goal Judge or assistant referee:** An official seated on the goal line responsible for assisting the referee in determining if the ball has entered the goal or passed the goal line, including who last touched the ball as well as for throwing a new ball according to the referees' instructions.

**Start or restart:** The commencement of play at the beginning of a period, after a goal or after the referee has called for the ball and stopped play.

## DURATION OF THE GAME

**Actual play:** Teams play four periods, each period consisting of eight minutes of actual playing time; a total of 32 minutes. Actual play starts at the beginning of each period, when a player touches the ball, stops on every stoppage indicated by the referee or shot clock and continues after every stoppage when the player puts the ball into play according to the Rules, shoots or passes the ball.

**Penalty Shoot-out:** The method of determining a definite result for a game should the scores be level at full time. The method is regulated by Appendix 6.

**Attacking Referee:** The referee who is giving primary attention to the attacking situation in front of the goal to the referee's right.

**Defensive Referee:** The referee who is controlling the attacking situation to the referee's left. This referee generally maintains a position behind the last attacking player position who is furthest back from the goal.

## TIMEOUTS

**Timeout:** A one-minute stoppage of play available to the attacking team at any time, except during VAR review. Each team is entitled to two timeouts per game.

**Illegal Timeout:** A requested timeout to which the team is not entitled.

**Possession:** Possession of the ball is when a player from one of the teams is holding the ball or swimming with the ball.

## METHOD OF SCORING

**Visibly putting the ball into play:** means that the ball must leave the hand of the player with the ball. Throwing the ball from a player's left to right hand is considered putting the ball into play.

**Fake:** To simulate a shot.

**Swim up:** At the beginning of a period the ball is placed in the middle of the field of play and once the whistle is blown to signal the start of the game, teams sprint towards the middle of the pool to gain possession of the ball.



## ORDINARY FOULS

**False Start:** To begin the start of play improperly, either before the signal from the referee or pushing off from or affecting the alignment of the goal.

**Foul:** A violation of a rule resulting in a stoppage of the game clock and the awarding of a free throw. There are two types of fouls:

Physical fouls (physical contact of a player preventing an opposing player from continuing with movement)

Technical fouls (against rules, e.g., false start or restart, to strike the ball with clenched fist, two hands, etc.)

**Ball under:** Ordinary foul called against a player for taking the ball under water when tackled by an opponent or with intent to hide the ball from an opponent.

**Simultaneous exclusion:** When two players from opposing teams are simultaneously excluded.

**Spirit of the Game:** Defining characteristic of the sport. Playing within the spirit means playing to win while respecting teammates, opponents and the game itself. It is defined by understanding the rules and playing with integrity and honesty in mind.

**Push-off:** To use the hand, arm, foot or another body part to push off an opponent to gain an advantage.

**Kicking:** A blow, strike or forceful thrust with the foot to an opponent's body or face, which is a personal foul.

**Simulation:** To pretend to be fouled.

**To drive:** An attacking move by a player who is facing an opponent and who attempts to aggressively swim by that player to a position of advantage closer to the goal.

**Driver:** A player who is driving towards the goal, usually starting from a stationary position facing an opponent attempting to aggressively swim by the opponent to a position of advantage closer to the goal.

**To tackle:** To hold, sink, pull back or impede a player who is holding the ball.

Half distance line: Line which divides the length of field of play into two equal halves at midpoint of course.

**Offensive Foul:** A foul committed by an attacking player resulting in a free throw awarded to the defending team.

**Holding the ball:** Lifting, carrying or touching the ball but not including dribbling the ball.

## EXCLUSION FOULS

**Improper Entry:** Entry of a player into the game during play not in accordance with the rules.

**Improper Re-entry:** Entry of a substitute into the game during play not in accordance with the rules.

**Exclusion Foul:** A foul where a player is excluded from taking part in the game for a period of time as prescribed in the Rules.

**Misconduct:** Any improper behaviour, including being disrespectful towards a referee or opponent, as well as showing disregard for an instruction from the referee.

**Violent action:** An action by a player intended to cause harm or to injure another player or official, regardless of whether contact is made.

**Aggressive foul play:** Behaviour that can lead to injuries of opponents. The intention of these kind of fouls is to destroy and completely stop the advantage or progress of the game or a player, or to provoke the opponent. It is dangerous play, without a clear intention to injure the opponent player, but typically is caused by emotions.

**Persistent foul play:** Unallowed fouls of defending players, which are stopping the attack. The intention of these fouls is not to injure an opponent, but to destroy the flow of the game, advantage and speed, as well as to intimidate the opponent.

**To Impede:** To obstruct movement with unallowed physical acts, like holding or blocking an opponent.

**To hold an opponent:** To use the hands, arms or legs to hold onto an opponent with the intention of restricting movement.



**To sink:** To push an opponent under the water.

**To Pull back:** To pull an opposing player.

**To interfere with a free throw, goal or penalty throw:** To disrupt or interfere with the taking of any of these throws.

**Disproportionate movements:** To make any movement with intent to kick or strike, even if the player fails to make contact.

**To strike:** Means "to hit".

**Tactical foul:** Any foul by a defender with the objective to stop the flow of the game with intent to take away an advantage, especially the counterattack.

**Counterattack:** The transition by the attacking team that brings the ball quickly from one end of the field to the other in an attempt to score before the defensive team can get into position.

## PENALTY FOULS

**Penalty Foul:** Any foul committed inside 6 metres preventing a probable goal (Part Six, Article 10.2 to 10.11). Additionally, violent action (Part Six, Article 9.14), and delaying the game (Part Six, Article 10.10) may result in a penalty as well (Part Six, Article 10.9).

**Probable goal situation:** Situations in which the attacking player is facing the goal and there is no defending player between the attacking player and the goalkeeper, and without a foul, a goal would most likely be scored. There are also probable goal situations when the goal is empty and the ball nearby, as well as examples described in the Manual.

**Bad pass:** A pass which cannot be reached by the attacker, regardless of whether or not the player has been fouled. There are no sanctions against the defending player in the case of a bad pass.

**Front position on a defender:** An offensive player establishing an advantageous position, that is, a position between a defending player and the opponent's goal.

**Delaying the game:** Intentionally preventing attacking players from proceeding with the action or any interference against the spirit of the game with the intention to prevent a probable goal.

**Illegal Player:** A player not entitled to participate in the game.

## FREE THROWS

**Free Throw:** A method of putting the ball into play after an ordinary foul, an exclusion foul or a restart after a timeout, a goal, an injury including bleeding, the replacement of a cap, the referee calling for the ball, the ball leaving the side of the field of play or any other delay.

**To block a shot or pass:** To stop the ball's flight with hand, arm or body.

**Shot:** An attempt to score by purposely directing the ball towards the opponent's goal

## GOAL THROWS

**Throw:** Any movement by hand releasing the ball, with intent to put the ball into play or pass or score.

**Free Throw:** The method of putting the ball into play following a foul or stoppage.

**Goal Throw:** The throw awarded to the defending team as described in Part Six, Article 12.

**Dribble the ball:** To swim with the ball or progress the ball by swimming. A player dribbling the ball is in possession of the ball but is not holding the ball.

**Pass the ball:** To throw the ball from one player to a teammate or to the area controlled by a teammate. To throw the ball towards a teammate (or to oneself) with the intention of keeping control of the ball (as opposed to the intention to score a goal).



## CORNER THROWS

**Corner Throw:** Throw awarded to the attacking team on the defender's 2m line as described in Part Six, Article 13.2.

**Direct shot:** The ball may be shot directly at the goal:

following a free throw when the player, the ball and the foul are outside the 6 M line,

from a penalty throw,

from a corner throw. (Described in Part Six, Article 7.2)

## NEUTRAL THROWS

**Neutral Throw:** Method of putting the ball into play when neither team has possession. The referee restarts play by throwing the ball into the pool between two opposing players, giving each an equal opportunity to recover the ball.

## PENALTY THROWS

**Penalty Throw:** A free shot at the goal from the 5 metre line defended only by the goalkeeper. The defending goalkeeper shall be positioned on the goal line between the goal posts and may move forward after the referee gives the signal for the shot to be taken. Defending players may only enter the 6 metre area after the ball has left the hand of the shooting player.

## PERSONAL FOULS

**Personal Foul:** Individualized foul recorded against a player, when the referee awards an exclusion or a penalty foul.

## ADDENDUM WITH SOME OTHER OBSERVATIONS AND CLARIFICATIONS:

**Transition:** The phase of the game when a team changes from offense to defense or from defense to offense.

**Attacking player:** Player whose team has possession of the ball; the team controls the ball and has the opportunity to score a goal.

**Defending player:** Player whose team does not control, and does not have possession of, the ball; a player trying to defend the team's goal.





**20.4 APPENDIX 4 - FIELD OF PLAY & EQUIPMENT**

**20.4.1 FIELD OF PLAY**

**20.4.1.1** The promoting organisation shall be responsible for the correct measurements and markings of the field of play and shall provide all required fixtures and equipment.

**20.4.1.2** The layout and markings of the field of play for a game officiated by two referees shall be in accordance with this diagram:

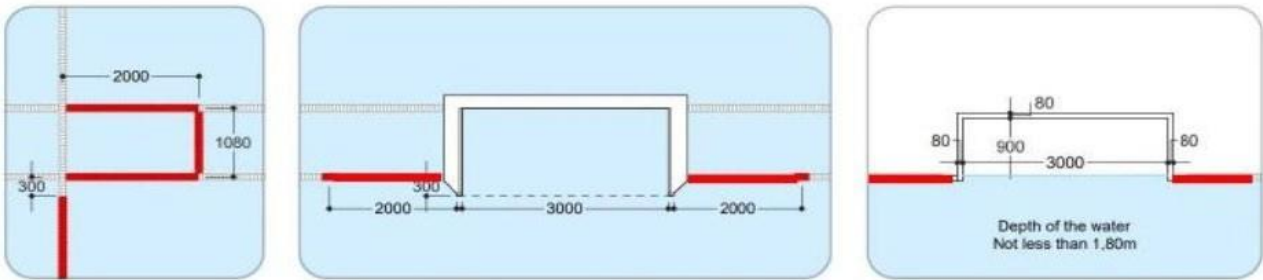

Boundary lines from the goal posts in 2m long shall be marked in red to distinguish the goal areas (Part Six, Appendix 3, Goal Area definition)

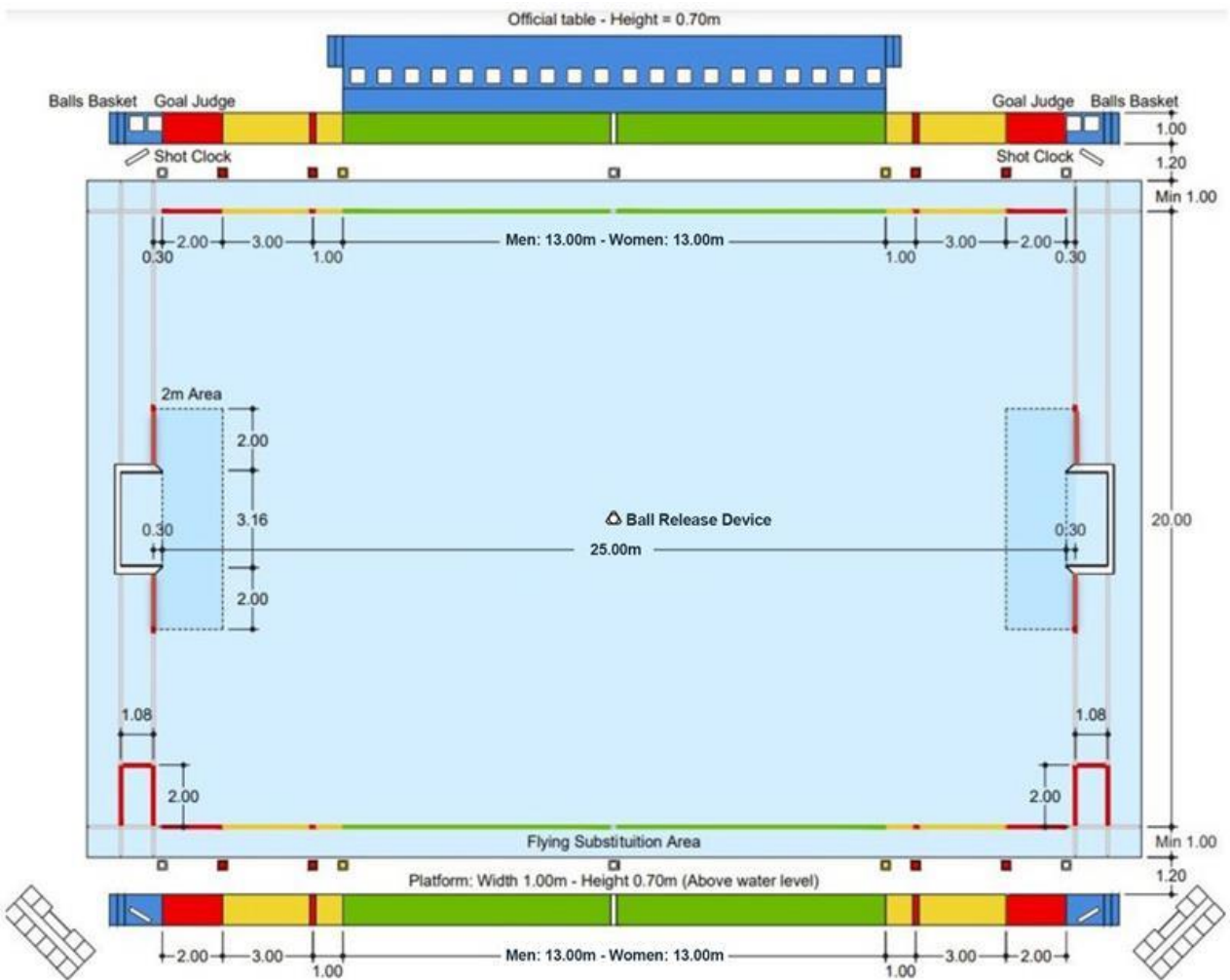



**20.4.1.3** In a game officiated by one referee, the referee shall officiate on the same side as the official table, and the goal judges shall be situated on the opposite side.

**20.4.1.4** For World Aquatics events, the dimensions of the field of play, water depth and temperature, and light intensity shall be as set forth in the Water Polo Facilities Rules. (Part Six, Article 18).

**20.4.1.5** Distinctive marks shall be provided on both sides of the field of play to denote the following:

- a) white marks - goal line and half distance line
- b) red marks - 2 metres from goal lines
- c) yellow marks - 6 metres from goal lines
- d) a red marker shall be placed 5 metres from goal lines to indicate the point from which a penalty shot must be taken.

The sides of the field of play from the goal line to the 2 metre line shall be marked in red; from the 2 metre line to the 6 metre line shall be marked in yellow and from the 6 metre line to the half distance line shall be marked in green.

**20.4.1.6** A red mark shall be placed at each end of the field of play, 2 metres from the corner of the field of play on the side opposite to the official table, to denote the exclusion re-entry area.

**20.4.1.7** Sufficient space shall be provided to enable the referees to have free movement from end to end of the field of play. Space shall also be provided at the goal lines for the goal judges.

**20.4.1.8** The secretary shall be provided with separate white, blue, red and yellow flags, each measuring 0.35 metres x 0.20 metres.

#### **20.4.2 GOALS**

**20.4.2.1** Two goal posts and a crossbar, rigidly constructed, rectangular with a dimension of 0.075 metres facing the field of play and painted white shall be located on the goal lines at each end, equal distances from the sides and not less than 0.30 metres in front of the ends of the field of play.

**20.4.2.2** The inner sides of the goal posts shall be 3 metres apart. When the water is 1.50 metres or more in depth, the underside of the crossbar shall be 0.90 metres from the water surface. When the water is less than 1.50 metres in depth, the underside of the crossbar shall be 2.40 metres from the floor of the pool.

**20.4.2.3** Limp nets shall be securely fastened to the goal posts and crossbar to enclose the entire goal area and shall be attached to the goal fixtures in such a manner as to allow not less than 0.30 metres clear space behind the goal line everywhere within the goal area.

#### **20.4.3 BALL**

**20.4.3.1** The ball shall be round and shall have an air chamber with a self-closing valve. It shall be waterproof, without external strapping or any covering of grease or similar substance.

**20.4.3.2** The weight of the ball shall be not less than 400 grammes and not more than 450 grammes.

**20.4.3.3** For games played by men, the circumference of the ball shall be not less than 0.68 metres and not more than 0.71 metres, and its pressure shall be 7.5 to 8.5 pounds per square inch atmospheric.

**20.4.3.4** For games played by women, the circumference of the ball shall be not less than 0.65 metres and not more than 0.67 metres, and its pressure shall be 6.5 to 7.5 pounds per square inch atmospheric.

#### **20.4.4 CAPS**

**20.4.4.1** Caps shall be of contrasting color, other than solid red, as approved by the referees, but also to contrast with the color of the ball. A team may be required by the referees to wear white or blue caps. The goalkeepers shall wear red caps with numbers and/or ear guards in the same colour as their team members' caps. Caps shall be fastened under the chin. If a player loses the cap during play, the player shall replace it at the next appropriate stoppage of the game when the player's team is in possession of the ball. Caps shall be worn throughout the entire game.

**20.4.4.2** Caps shall be fitted with malleable ear protectors which shall be the same color as the team's caps.



- 20.4.4.3** Caps shall be numbered on both sides with numbers 0.10 metres in height. The goalkeeper shall wear a cap no. 1 and the other caps shall be numbered 2 to 14 (or 15 in case it is allowed in a specific tournament on the team roster). A substitute goalkeeper shall wear any cap, numbered from 2 to 14, which must be a red cap. A player shall not be allowed to change cap number during the game except with the permission of a referee and with notification to the secretary. A player or substitute (re-)entering the field of play during actual play must wear the cap otherwise shall be deemed guilty of an offence under Part Six, Article 10.12 (Improper Entry or Re-Entry).
- 20.4.4.4** For international games, the caps shall display on the front the international three letter country code and may display the national flag. The country code shall be 0.04 metres in height.
- 20.4.5** **VISIBLE CLOCKS**
- 20.4.5.1** Any visible clock shall show the time in a descending manner.

**20.5 APPENDIX 5 - OFFICIALS****20.5.1 OFFICIALS FOR WORLD AQUATICS EVENTS**

**20.5.1.1** For World Aquatics events the officials shall consist of two referees, two assistant referees, timekeepers and secretaries and a video assistant referee, each with the following powers and duties. These officials shall also be provided wherever possible for other events, except that in a game refereed by two referees and no assistant referees, the referees shall assume the duties (but without making the specified signals) allocated to the assistant referees.

Depending on the degree of importance, games can be controlled by teams of four to nine officials, as follows:

- a) Referees and assistant referees: Two referees and two assistant referees; or two referees and no assistant referees; or one referee and two assistant referees.
- b) Timekeepers and secretaries: With one timekeeper and one secretary: The timekeeper shall record the periods of continuous possession of the ball by each team, in accordance with Part Six, Article 8.12. The secretary shall record the exact periods of actual play, timeouts and the intervals between periods, maintain the record of the game as set out in Part Six, Appendix 5, Article 20.5.5 and shall also record the respective periods of exclusion of players ordered from the water in accordance with the Rules.

With two timekeepers and one secretary: Timekeeper No. 1 shall record the exact periods of actual play, timeouts and the intervals between periods. Timekeeper No. 2 shall record the periods of continuous possession of the ball by each team, in accordance with Part Six, Article 8.12. The secretary shall maintain the record of the game and perform all other duties as set out in the Water Polo Rules.

With two timekeepers and two secretaries: Timekeeper No. 1 shall record the exact periods of actual play, timeouts and the intervals between periods. Timekeeper No. 2 shall record the periods of continuous possession of the ball by each team, in accordance with Part Six, Article 8.12. Secretary No. 1 shall maintain the record of the game. Secretary No. 2 shall carry out the duties relating to the improper re-entry of excluded players, improper entry of substitutes, exclusion of players and the third personal foul.

- c) Video assistant referee: shall assist the two referees as called for by the Rules.

**20.5.2 REFEREES**

**20.5.2.1** The use of audio equipment by the referees of the match. During the match, both referees shall have an audio headset for communication between themselves. The delegate and the VAR assistant referees will also have one, but only to receive information for the official table and to ensure clarity.

**20.5.2.2** All decisions of the referees on questions of fact shall be final and their interpretation of the Rules shall be obeyed throughout the game. The referees shall not make any presumption as to the facts of any situation during the game but shall interpret what they observe to the best of their ability.

**20.5.2.3** The referees shall whistle to start and restart the game and to declare goals, goal throws, corner throws (whether signalled by the assistant referee or not), neutral throws and infringements of the Rules. A referee may alter a decision provided it is done before the ball is put back into play.

**20.5.2.4** The referees shall have the power to order any player from the water in accordance with the appropriate Rule and to abandon the game should a player refuse to leave the water when so ordered.

**20.5.3 ASSISTANT REFEREES**

**20.5.3.1** The assistant referees shall be situated on the same side as the official table, each on the goal line at the end of the field of play.

**20.5.3.2** The duties of the assistant referees shall be:

- a) to signal by raising one arm vertically when the players are correctly positioned on their respective goal lines at the start of a period;
- b) to signal by raising both arms vertically for an improper start or restart;
- c) to signal by pointing with the arm in the direction of the attack for a goal throw;
- d) to signal by pointing with the arm in the direction of the attack for a corner throw;
- e) to signal by raising and crossing both arms for a goal;



- f) to signal by raising both arms vertically for an improper re-entry of an excluded player or improper entry of a substitute.

**20.5.3.3** Each assistant referee shall be provided with a supply of balls and when the original ball has gone outside the field of play, the assistant referee shall immediately throw a new ball to the goalkeeper (for a goal throw), to the nearest player of the attacking team (for a corner throw), or as otherwise directed by the referee.

#### **20.5.4 TIMEKEEPERS**

**20.5.4.1** The duties of the timekeepers shall be:

- a) to record the exact periods of actual play, timeouts and the intervals between the periods;
- b) to record the periods of continuous possession of the ball by each team;
- c) to record the exclusion times of players ordered from the water in accordance with the Rules, together with the re-entry times of such players or their substitutes;
- d) to audibly announce the start of the last minute of the game;
- e) to signal by whistle after 45 seconds and at the end of each timeout.

**20.5.4.2** A timekeeper shall signal by whistle (or by any other means provided it is distinctive, acoustically efficient and readily understood), the end of each period independently of the referees and the signal shall take immediate effect except:

- a) in the case of the simultaneous award by a referee of a penalty throw, in which event the penalty throw shall be taken in accordance with the Rules;
- b) if the ball is in flight and crosses the goal line, in which event any resulting goal shall be allowed.

#### **20.5.5 SECRETARIES**

**20.5.5.1** The duties of the secretaries shall be:

- a) to maintain the record of the game, including the players, the score, timeouts, exclusion fouls, penalty fouls, and personal fouls awarded against each player;
- b) to control the periods of exclusion of players and to signal the expiration of the period of exclusion by raising the appropriate flag or by another approved method of signalling; except that a referee shall signal the re-entry of an excluded player or a substitute when that player's team has retaken possession of the ball. After 4 minutes, the secretary should signal the re-entry of a substitute for a player who has been excluded for violent action by raising the yellow flag along with the appropriate coloured flag or by another approved method of signalling;
- c) to signal with the red flag and by whistle, or by another approved method of signalling, for any improper re-entry of an excluded player or improper entry of a substitute (including after a signal by an assistant referee to indicate an improper re-entry or entry), which signal shall stop play immediately;
- d) to signal, without delay, the award of a third personal foul against any player as follows:
  - with the red flag, or by another approved method of signalling, if the third personal foul is an exclusion foul;
  - with the red flag and a whistle, or by another approved method of signalling, if the third personal foul is a penalty foul.

#### **20.5.6 VIDEO ASSISTANT REFEREE**

**20.5.6.1** The duties of the Video Assistant referee shall be:

- a) to alert and assist the match referee(s) in doubtful "goal / no goal" situations or in case of violent action situations by providing the video footage at the appropriate moment.
- b) if necessary, in other situations, to provide assistance to the referees with video footage;
- c) to show the match referee(s) re-plays of other incidents, when requested.





#### **20.5.7 INSTRUCTIONS FOR THE USE OF TWO REFEREES**







- 20.5.7.1** The referees are in absolute control of the game and shall have equal power to declare fouls and penalties. Differences of opinion of the referees shall not serve as a basis for protest or appeal.
- 20.5.7.2** The committee or organisation appointing the referees shall have power to designate the side of the pool from which each referee shall officiate. Referees shall change sides of the pool before the start of any period when the teams do not change ends.
- 20.5.7.3** At the start of the game and of each period, the referees will position themselves on the respective six (6) metre line. The starting signal shall be given by the referee on the same side as the official table.
- 20.5.7.4** After a goal, the signal to restart shall be given by the referee who was controlling the attacking situation when the goal was scored. Before restarting, the referees shall ensure that any substitutions have been completed.
- 20.5.7.5** Each referee shall have the power to declare fouls in any part of the field of play but each referee shall give primary attention to the offensive situation attacking the goal to the referee's right. The referee not controlling the attacking situation (the defensive referee) generally shall maintain a position no closer to the goal being attacked than that player of the attacking team furthest back from the goal.
- 20.5.7.6** When awarding a free throw, goal throw or corner throw, the referee making the decision shall blow the whistle and both referees shall indicate the direction of the attack, to enable players in different parts of the pool to see quickly which team has been awarded the throw. Referees shall use the signals set out in the following C.8 to indicate the nature of the fouls which they are penalizing.
- 20.5.7.7** The signal for a penalty throw to be taken shall be made by the attacking referee, except that a player who wishes to take the throw with the left hand may request the defensive referee to make the signal.
- 20.5.7.8** When simultaneous awards are made for ordinary fouls but for opposing teams, the award shall be a neutral throw by the attacking referee. When simultaneous awards are made by both referees and one is for a goal throw and the other is for a corner throw, the corner throw award shall be applied unless otherwise determined after VAR review, if applicable.
- 20.5.7.9** When simultaneous awards are made by both referees and one is for an ordinary foul and the other is for an exclusion foul or penalty foul, the exclusion foul or penalty foul award shall be applied.
- 20.5.7.10** When players of both teams commit an exclusion foul simultaneously during play, the referees shall call the ball from the water and make sure both teams and the secretaries know who is excluded. The possession clock is not reset and play is restarted with a free throw to the team which had possession of the ball. If neither team had possession when the simultaneous exclusions were called, the possession clock is reset to 25 seconds in men's category and 30 seconds in women's category and play shall be restarted with a neutral throw.
- 20.5.7.11** In the event of simultaneous awards of penalty throws to both teams, the first throw shall be taken by the team last in possession of the ball. After the second penalty throw has been taken, the game will restart with the team which had possession of the ball receiving a free throw on or behind the half distance line. The possession clock is reset to 25 seconds in men's category and 30 seconds in women's category.



**20.5.8 SIGNALS TO BE USED BY OFFICIALS**





<p><b>A.</b> The referee lowers the arm from a vertical position to signal (i) the start of the period (ii) to restart after a goal (iii) the taking of a penalty throw</p>	
<p><b>B.</b> To point with one arm in the direction of the attack and, if necessary, to use the other arm to indicate the place where the ball is to be put into play at a free throw, goal throw or corner throw.</p>	
<p><b>C.</b> To signal a neutral throw. The referee points to the place where the neutral throw has been awarded, points both thumbs up and calls for the ball.</p>	
<p><b>D.</b> To signal the exclusion of a player. The referee points to the player and then moves the arm quickly towards the boundary of the field of play. The referee then signals the excluded player's cap number so that it is visible to the field of play and the table.</p>	







<p><b>E.</b> To signal the simultaneous exclusion of two players. The referee points with both hands to the two players, signals their exclusion in accordance with Fig. D, and then immediately signals the players' cap numbers.</p>	
<p><b>F.</b> To signal the exclusion of a player for misconduct. The referee signals exclusion in accordance with Fig. D (or Fig. E if appropriate) and then rotates the hands round one another in such a way that is visible to both the field of play and the table in addition to issuing the player with a red card. The referee then signals the excluded player's cap number to the table.</p>	
<p><b>G.</b> To signal the exclusion of a player with substitution after four (4) minutes. The referee signals exclusion in accordance with Fig D (or Fig. E if appropriate) and then crosses the arms in such a way that is visible to both the field of play and the table in addition to issuing the player with a red card. The referee then signals the excluded player's cap number to the table.</p>	
<p><b>H.</b> To signal the award of a penalty throw. The referee raises an arm with five fingers in the air. The referee then signals the offending player's cap number to the table.</p>	
<p><b>I.</b> To signal that a goal has been scored. The referee signals by whistle and by immediately pointing to the centre of the field of play.</p>	









<p><b>J.</b> To indicate the exclusion foul of holding an opponent. The referee makes a motion holding the wrist of one hand with the other hand.</p>	
<p><b>K.</b> To indicate the exclusion foul of sinking an opponent. The referee makes a downward motion with both hands starting from a horizontal position.</p>	
<p><b>L.</b> To indicate the exclusion foul of pulling back an opponent. The referee makes a pulling motion with both hands vertically extended and pulling towards their body.</p>	
<p><b>M.</b> To indicate the exclusion foul of kicking an opponent. The referee makes a kicking movement.</p>	
<p><b>N.</b> To indicate the exclusion foul of striking an opponent. The referee makes a striking motion with a closed fist starting from a horizontal position.</p>	





<p><b>O.</b> To indicate the ordinary foul of pushing or pushing off from an opponent. The referee makes a pushing motion away from the body starting from a horizontal position.</p>	
<p><b>P.</b> To indicate the exclusion foul of impeding an opponent. The referee makes a crossing motion with one hand horizontally crossing the other.</p>	
<p><b>Q.</b> To indicate the ordinary foul of taking the ball under the water. The referee makes a downward motion with a hand starting from a horizontal position.</p>	
<p><b>R.</b> To indicate the ordinary foul of standing on the bottom of the pool. The referee raises and lowers one foot.</p>	
<p><b>S.</b> To indicate the ordinary foul of undue delay in the taking of a free throw, goal throw or corner throw. The referee raises a hand once or twice with the palm turned.</p>	





<p><b>T.</b> To indicate the ordinary foul of a violation of the two-metre rule. The referee indicates the number 2 by raising the fore and middle fingers in the air with the arm vertically extended.</p>	
<p><b>U.</b> To indicate the ordinary foul of expiry of possession time. The referee moves a hand in a circular motion two or three times.</p>	
<p><b>V.</b> To indicate that a shot from outside the 6 m. area is permitted.</p>	
<p><b>V1.</b> To raise up the yellow card and point with one arm parallel to the side line in the direction of the location of the sanctioned team's bench to indicate the <u>team</u> which is sanctioned with a yellow card in the circumstances of Part Six, Articles 9.13.3.</p>	
<p><b>V2.</b> To raise up the yellow card and point with one arm in the direction of the head coach sanctioned with a yellow card in the circumstances of Part Six, Articles 16.3.1.</p>	



<p><b>V3.</b> To raise up the red card and point with one arm in the direction of the head coach or other team official or player to indicate the person sanctioned with a red card in the circumstances of Part Six, Articles 16.3.2 or as additional signal in case of exclusion of a player from the remainder of the game in the circumstances of Part Six, Articles 9.13 or 9.14.</p>	
<p><b>W.</b> To indicate a change of possession.</p>	
<p><b>X.</b> By an assistant referee to signal for the start of a period.</p>	



<p><b>Y.</b> By an assistant referee to signal an improper start, restart or improper re-entry of an excluded player or substitute.</p>	
<p><b>Z.</b> By an assistant referee to signal a goal throw or corner throw.</p>	
<p><b>AA.</b> By an assistant referee to signal a goal.</p>	

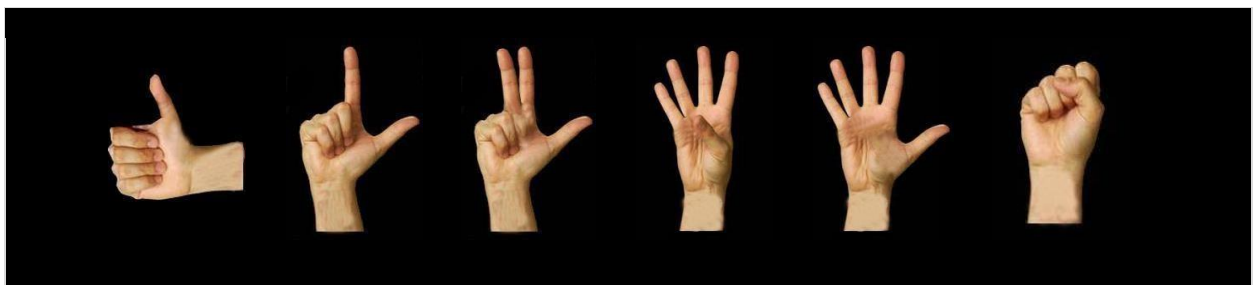

To indicate a player's cap number. To enable the referee to communicate better with the players and the secretary, signals are made using both hands if appropriate where the number exceeds five. One hand shows five fingers with the other hand showing additional fingers to make up the sum of the player's number. For the number ten, a clenched fist is shown. If the number exceeds ten, one hand is shown as a clenched fist with the other hand showing additional fingers to make up the sum of the player's number.

**20.6 APPENDIX 6 - PENALTY SHOOT OUT**
**20.6.1 Officials Involved**

**20.6.1.1 Delegates:** priority to check if the shooters can participate in PSO (no player with three (3) personal fouls or has received a red card or can no longer participate due to injury) and to control the same order of shooters (five (5) shooters) after the first round of penalties has taken place.

**20.6.1.2 Referees:** priority to control the field of play, benches, position of goalkeepers and shooters in the field of play.

**20.6.1.3 Video Assistant Referee:** goal no goal assistant if needed.

**20.6.2 Procedure**

**20.6.2.1** If a penalty shootout (PSO) has to determine the outcome of a game (according to VI 4.3), the following procedure and protocols must be followed.

**20.6.2.2** Immediately after the end of the 4th period, there is a **3-minutes break** during which the following actions need to be completed:

- a) the players leave the water and sit on their respective team benches, except for five (5) shooters from each team who will remain in the field of play in their respective team's half of the field of play and out of 6m line, and the goalkeepers. Shooters shall not hang on the lane ropes.
- b) the goalkeepers change ends and position themselves in the goal in the opposite team's half of the field. Substitute goalkeepers can remain on the bench or they can be before the start of the PSO procedure on the opposite side of the benches out of the field of play and out of 6 meters in their designated area before the start of the PSO.
- c) the referee who last officiated on the side of the team benches will call the team captains and with a coin toss will determine which team will shoot the first penalty. The team who wins the coin-toss can decide which teams starts the penalty-shoot-out.
- d) Assistant referees are not involved in PSO.

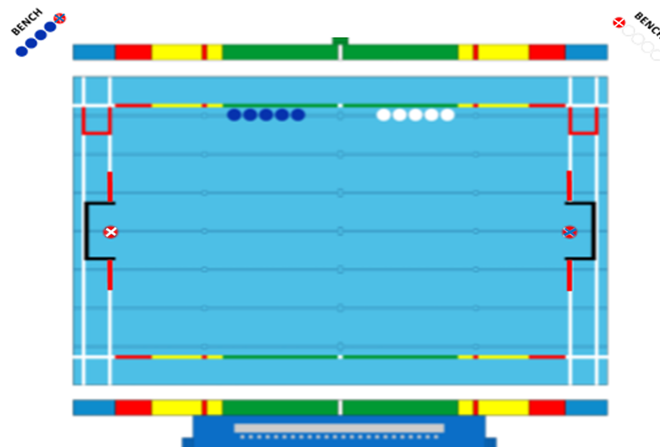

**20.6.2.3** After the end of the 3-minute break, the PSO will start immediately. If the two teams are ready before the 3 minutes expire, the referees can stop the descending clock and start the PSO earlier. If a team fails to be ready on time, the team's coach shall be warned by issuing a yellow card. If the coach has already been warned with a yellow card, a red card shall be issued for delaying the PSO. If the head coach has already been excluded, any other bench official can only receive a red card for delaying the PSO.

**20.6.2.4** When shooting alternately at each goal, only one referee will control each penalty. Referees will position themselves on the 5-metre lines at opposite ends of the field such that right-handed shooters can easily observe the referee's signals. A referee will only walk to the other end of the field if a left-handed shooter is ready to take the next penalty.

**20.6.2.5** Multiple balls can be used for the PSO. The ball shall not be thrown from one end of the field to the other. Each side will use their own set of balls.



- 20.6.2.6** The order in which shooters of each team shall be determined is the order in which they shoot the first round of five (5) penalties. (No list of shooters needs to be written down before the start of the PSO.) The secretary shall record the numbers of the players who take the penalties and, together with the delegate, shall check that the shooters are eligible to participate in the PSO (no three (3) personal fouls or excluded with red card, or due to injury). If the teams are tied after the first round of five (5) penalty shots, the same players shall continue in the same order as established after the first round of penalty takers.
- 20.6.2.7** Shots will be taken alternately at each end of the field of play, unless conditions at one end of the field of play advantage and/or disadvantage a team, in which case all shots may be taken at the same end.
- 20.6.2.8** If during the shootout procedure the defending goalkeeper fails to take up the correct position on the goal line at the taking of a penalty throw having been ordered once to do so by the referee, the goalkeeper shall be excluded and a player from the five players participating in the penalty shootout may take the position of the goalkeeper but without the goalkeeper's privileges. Following the taking of the penalty throw, the goalkeeper or a substitute shall be permitted to (re)-enter except in the circumstances of Part Six, Article 16.2.
- 20.6.2.9** If at the taking of a penalty throw the goalkeeper moves forward before the referee blows the whistle and the player takes the shot and goal is not scored, the goalkeeper shall be excluded and the penalty throw shall be re-taken according to Part Six, Article 20.6.2.8. The goalkeeper or a substitute shall be permitted to (re)-enter according to Part Six, Article 20.6.2.8.
- 20.6.3 Substituting the goalkeeper.**
- 20.6.3.1** Substituting the goalkeeper, during the PSO, is allowed according to the following procedure (see below the green arrows):
- The substitute goalkeeper has to walk to the half distance line and then to swim to the goal and take the position of the first goalkeeper.
  - The goalkeeper who is substituted must swim to the side of the jury table and to wait out of 6 meters and outside the field of play (to be re-substituted or until the end of PSO).

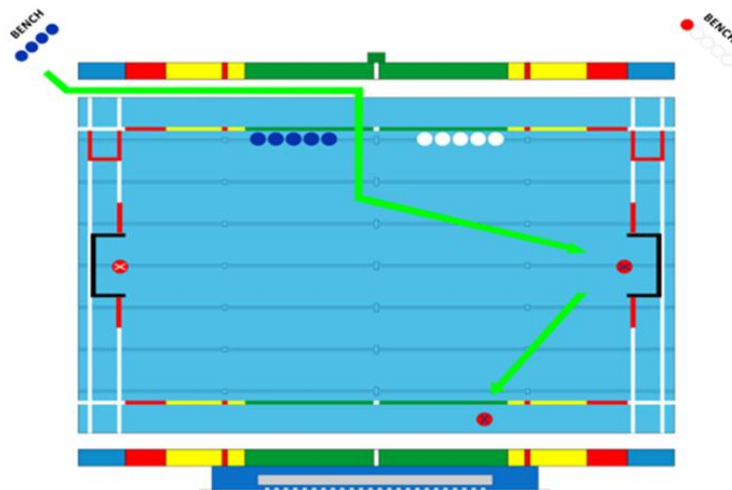

**20.6.4 Re-substituting the goalkeeper**

**20.6.4.1** It is possible to substitute the goalkeeper again during a PSO by swimming according to the green arrows below:

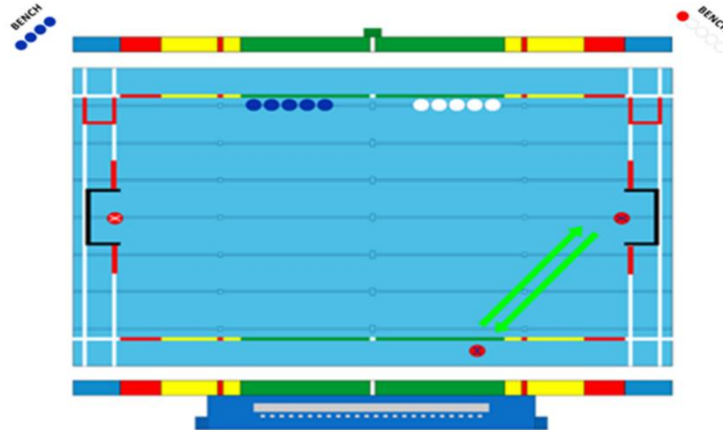
**20.6.5 Exclusion of goalkeeper and players during penalty shoot out**

**20.6.5.1** If the goalkeeper is excluded from the remainder of the game during the penalty shoot out (other than the circumstances of V1.16.2.), a player from the five players participating in the penalty shootout may take the position of the goalkeeper but without the privileges of the goalkeeper; following the taking of the penalty throw, the excluded goalkeeper can take part in the PSO again. The excluded goalkeeper may be also substituted by the substitute goalkeeper or an alternate goalkeeper if substitute goalkeeper is not entitled or able to participate, who shall wear the goalkeeper's cap.

**20.6.5.2** If a field player is excluded from the remainder of the game during the penalty shoot out, the player's position is removed from the sequence of the five players participating in the penalty shoot out, and a substitute player is placed in the last position of the sequence.

**20.6.6 6. Summary**

During the PSO:

The secretary and the delegate control the correct order of the shooters and the score.

The referees manage the teams.

No warming up is allowed during the PSO.

All players not involved in the PSO must sit on the bench together with the team officials.

During the PSO, none of the players is allowed to hang onto the line.

A goalkeeper can substitute by swimming, as indicated in the PSO protocol, to the goal.

The substituted goalkeeper will stay in the water, out of the 6 metre line and outside the field of play.

Every subsequent substitution of the goalkeeper occurs in a similar manner.





## 20.7 APPENDIX 7 - VAR PROTOCOL

The purpose of World Aquatics VAR protocol is to provide the integrity, transparency for all Water Polo games and eliminate the failure of the human factor with the assistance of modern technology.

### 20.7.1 PRINCIPLES

The final decision is always made by the referees. The referee can change his/her original decision based on facts from the VAR review.

Only the referee of the match can request a review. The Video Assistant Referee and the delegate can only alert the referee to conduct a review.

The referee will stop the match at an appropriate moment, as soon as possible.

During a VAR review the referee should remain visible throughout the process.

Accuracy is more important than speed, therefore there is no time pressure to review the decision quickly.

A match is not invalidated because of malfunction(s) of the VAR technology, wrong decision(s) involving the VAR, decision(s) not to review an incident or review(s) of a non-reviewable situation.

#### 20.7.1.1 Appropriate moment definition

- Neither team has possession of the ball
- Interval time
- Corner throw
- Team in possession of the ball has no clear advantage.
- At the latest, the review should be done no later than the first attack following the situations described in Rule 20.7.2 of this Appendix and needs to be reviewed. A review is not possible after the completion of the first attack.

### 20.7.2 SITUATIONS FOR REVIEW DURING THE MATCH

**The use of VAR is limited to the following categories of decisions:**

1. Goal/No goal.
2. Goal scored at shot clock expiration or at the end of a period.
3. Jury table errors and/or failures of the electronic system including time out buttons.
4. When there is a shot taken at the end of a period and there is an excluded player.
5. Review of a violent action situation.
6. Interference with the taking of a penalty throw.
7. Improper or illegal entry, or re-entry of players.
8. Corner Throw of Goal Throw.

#### 20.7.2.1 Goal/No goal situation

If the referee or VAR official has doubt about a goal/no goal situation, the referee should review the situation to assess if the ball fully crossed the goal line.

##### 20.7.2.1.1 If a goal has been awarded:

- One of the referees of the match shall signal that the goal must be reviewed.
- One of the referees takes the ball out of the water.
- One referee, closest to the VAR monitor, reviews the situation and takes the decision to allow or disallow the goal.
- If the goal is cancelled, the former defending goalkeeper will restart the game with a free throw. The players shall take up positions anywhere within their respective halves of the field of play.
- If the goal is allowed, the game restarts according to Part Six, Article 6.4.

##### 20.7.2.1.2 If a goal was not awarded:

The Referees of the match must find an appropriate moment, as quickly as possible after the situation, to review it. It should happen no later than right after the end of the first attack following the doubtful "GOAL/NO GOAL" situation.

After reviewing if a goal is awarded:



the game restarts according to Part Six, Article 6.4 the time is reset to the moment when the goal was scored, all goals, timeouts and personal fouls are nullified but all yellow and red cards, acts of violence and misconduct will remain on the match protocol.

After reviewing if a goal is not awarded:

the game restarts with a free throw taken by the team which last had possession, the time is not reset, and the players shall take up positions anywhere within their respective halves of the field of play.

#### **20.7.2.2 A Goal scored at the expiration of the shot clock or at the end of a period**

When a goal was scored very close to shot clock time expiration, or during the time expiration at the end of a period, the referee should check if the ball left the hand of the attacker before the time expired.

The video review will only be done immediately after a goal was scored from this shot.

If the result of the shot was a corner a goal throw, or a rebound not followed by a goal of the attacking team throw no video review shall be done.

A rebound followed by a goal scored from another shot of the attacking team, a video review shall be made to check if the ball left the hand of the attacker before the time expired when the first shot resulted in the rebound.

If this situation happens at the end of a period or end of the game, the period or the game will not be ended. After the referee has done a VAR review and made the decision public, the referees will end the period or game.

#### **20.7.2.3 An excluded player at the end of a period**

When a player is excluded at the end of a period, and at the expiration of time the attacking team shoots at the goal, the VAR equipment must be used to assess if there was a change of possession in order to determine if the following period of the match will be restarted with both teams even, or with one player still excluded.

No other situations other than mentioned in Part Six, Appendix 7, Article 20.7.2.2 and 20.7.2.3 can be considered for VAR review after time expires.

#### **20.7.2.4 Technical errors by jury table officials and / or malfunctioning of electronic equipment (game clock, shot clock, time-out devices)**

In situations when technical errors of the table officials or malfunctioning of electronic equipment occurs, the referee may use the VAR system to determine the correct solution for the situation.

Determining and resolving the situation shall be made before the match is restarted.

#### **20.7.2.5 Suspicion of an incident of violence**

If the referee or VAR referee or delegate suspect that a violent action may have occurred, the referees may use VAR to review the situation. In this situation referee's decision can be:

1. Violent Action
2. Misconduct
3. No Call
4. Simulation

If the game is stopped at the moment of suspicion of violence:

- if a violent action is determined, the referees will sanction the incident according to the rules and the game should recommence from the time of the incident.
- If not a violent action but a misconduct was determined, the referees will sanction the incident according to the rules, and the game should recommence from the time of the incident.
- If simulation is determined, the referees shall issue yellow card (or red card as the case may be) to the team whose player has committed simulation, and the game will start with the free throw taken by the opposing team.
- If none of a violent action a misconduct or simulation is determined, the game will proceed according to the rules.



If the game was stopped at an appropriate moment and a violent action or misconduct was determined, all goals, timeouts and personal fouls between the time of the incident and time of stoppage are then nullified, but all yellow and red cards, acts of violence and misconduct, will remain on the match protocol.

In the case of suspicion of an incident of violence, video replays at the venue's video boards, broadcast video-clips, including under water scenes, can be used for VAR review.

#### **20.7.2.6 Interference during the taking of a penalty throw**

In situations when the referees or VAR referee suspect interference during the taking of a penalty throw, the referees can use the VAR equipment to check the situation.

Based on the decision, the game continues from the appropriate moment as described in the rules.

#### **20.7.2.7 Improper or illegal entry, or re-entry of players**

In situations when the referees or VAR referee suspect an improper or illegal entry, or re-entry of player(s), the referees can use the VAR equipment to check the situation. Based on the decision, the game continues from the appropriate moment as described in the rules.

#### **20.7.2.8 Corner Throw or Goal Throw**

Following an attacking player's missed shot on net, the match referees and the VAR-specific referee may use VAR equipment to decipher whether play resumes with a corner throw or goal throw.

### **20.7.3 REVIEW PROCESS**

#### **Step 1**

- a) The referee informs the VAR that a decision/incident should be reviewed (check).
- b) The VAR official or delegate recommends to the referees that a decision/incident should be reviewed (check).

#### **Step 2**

The referees, if necessary, decide to stop the game to review the video at an appropriate moment (see 1.1).

#### **Step 3**

Reviewing the doubtful situation on the VAR monitor.

#### **Step 4**

The referee communicates the final decision by going to the centre of the field of play and clearly indicating the decision and how the match will continue.

The Public Announcer must announce both the stoppage of the game to review the situation as well as the referee's decision after the review. A message may be displayed on the scoreboard as well.

#### **Step 5**

Restart of the game after the final decision.

### **20.7.4 POSITION OF THE PLAYERS DURING A VAR REVIEW**

Players must remain in their respective halves of the field of play during the VAR review.

During any Video Review, no substitution is allowed from any of the re-entry areas before the referee communicates the decision after the Video Review.

The referee who is not reviewing VAR should control the players of both teams so that they can take up the correct positions in the field.

### **20.7.5 NO REASON FOR PROTEST**

The result of a match should not be invalidated because of malfunction(s) of the VAR technology, wrong decision(s) involving the VAR, decision(s) not to review an incident or review(s) of a non-reviewable situation.

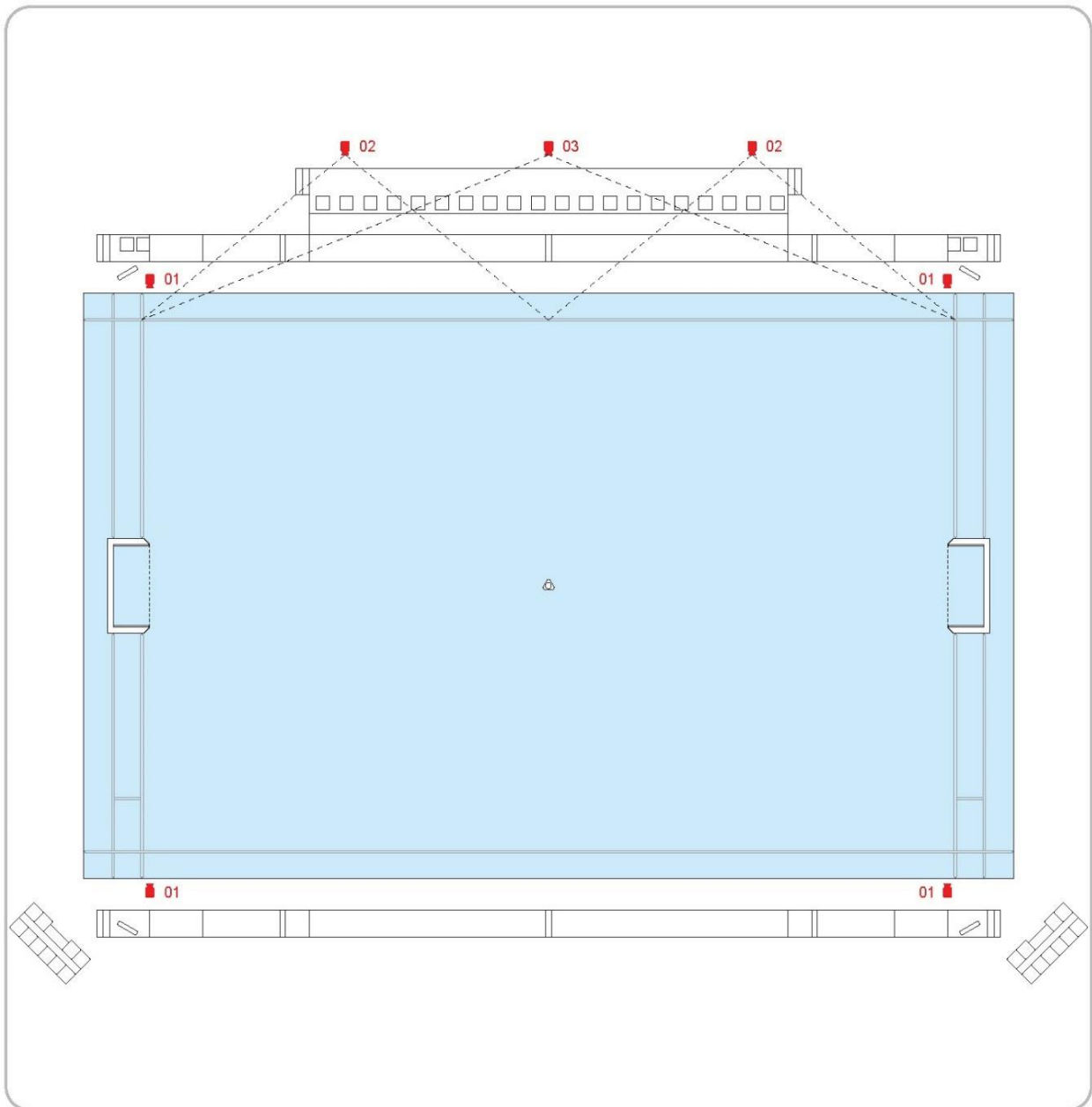
**Cameras**

1. Four cameras on the goal lines, two per goal. The location of the cameras should be at the edge of the pool or under referee's catwalk at about 1 m above the water level
2. Two cameras shall be fixed on the same side of the jury table. Each camera should film each a half of the field of play accordingly. The location of the cameras shall be that provide the best quality of video recording.
3. One camera is located at the side of the pool opposite to the benches. This camera shall film the entire field of play including both benches. This camera shall be capable to shoot at biggest possible angle (160 degrees is maximum today) with minimum resolution 2K pixels.

**20.8 APPENDIX 8 - AGE GROUP TOURNAMENTS**

**20.8.1** All age group competitors remain qualified from 1 January to the following 31 December at their age at the close of day (12 midnight) on 31 December of the year of competition.

**20.8.2** Age grouping for Water Polo for boys and girls are as follows:

- 15 and 16 years of age and under (16U)
- 17 and 18 years of age and under (18U)
- 19 and 20 years of age and under (20U)

**20.9 APPENDIX 9 - TOURNAMENT STRUCTURE**
**20.9.1 Water Polo Tournaments at Olympic Games and World Aquatics Championships**
**20.9.1.1 Olympic Games - Tournament Men**
**20.9.1.1.1 Draw**

The draw for the Olympic Games Tournament will be either on the last day of the Olympic Games Qualification Tournament - Men or as otherwise determined and the following principle shall apply: if a team is already qualified by its ranking from a preceding qualification competition, the team will be placed on the highest line of the draw according to that ranking and the team taking its place will be placed on the lower line.

For the Preliminary Round, all qualifying teams will be drawn by pairs into two groups, either A or B.

First Line, the first and second placed teams from the previous World Championship will be drawn, one into A, and one into B.

Second Line, the team qualified from the preceding year's World League and the team representing the Continent of Europe will be drawn, one into A, and one into B.

Third Line, the teams representing the Continents of America and Oceania will be drawn, one into A, and one into B.

Fourth Line, the teams representing the Continents of Africa and Asia will be drawn, one into A, and one into B.

Fifth Line, the first and second placed teams from the Olympic Games Qualification Tournament - Men will be drawn, one into A, and one into B.

Sixth Line, the third placed team in the Olympic Games Qualification Tournament

Men and the team representing the Host Country will be drawn, one into A, and one into B.

Should there be no teams from the previous Championships to seed onto a Line then the highest ranked teams for Europe, Americas, Asia, Africa or Oceania if any, shall be drawn alternating between Group A and Group B.

After being divided into group A and group B, the teams will then be drawn with each team in each group receiving a separate number from one (1) to six (6).

**20.9.1.1.2 Schedule of Games**
**Preliminary Round:**

There will be two (2) groups of six (6) teams, which form groups A and B.

Each group will play a round robin. The four (4) highest ranked teams in each group will qualify for the Quarter Final Round. The fifth and sixth ranked teams in each group will be eliminated and will not play anymore.

Day 1	Day 2	Day 3	Day 4	Day 5
1. A1-A6	7. B6 - B4	13. A4 - A5	19. B6 - B5	25. A5 - A1
2. A3-A4	8. B5 - B3	14. A2 - A6	20. B1 - B4	26. A3 - A6
3. A2-A5	9. B1 - B2	15. A3 - A1	21. B2 - B3	27. A4 - A2
4. B1-B6	10. A6 - A4	16. B4 - B5	22. A6 - A5	28. B3 - B6
5. B3-B4	11. A5 - A3	17. B2 - B6	23. A1 - A4	29. B4 - B2
6. B2-B5	12. A1 - A2	18. B3 - B1	24. A2 - A3	30. B1 - B5

**Quarter Final Round:**

The first, second, third and fourth placed teams in Group A and Group B form a Group D of eight (8) teams. Group D plays a modified single elimination format.

Games played in the Preliminary Round may be repeated in the Quarter Final, Semi Final or Final Round. All games played in Group D must be played so that a definite winner is declared. Accordingly, it may be necessary to apply the Water Polo Rules relating to penalty shoot-out.



#### Places 11 - 12

The teams ranked sixth in each group of the Preliminary Round shall be classified for places 11 - 12 according to the following criteria:

Win-loss record in their Preliminary Round group.

If both teams have the same win-loss record, the classification will be determined by goal average (goals scored divided by games played) taking into account the results of all games played in the respective group.

#### Places 9 - 10

The teams ranked fifth in each group shall be classified for places 9 - 10 according to the same principles as for places 11 - 12.

---

**Day 6**

---

31. 1A - 4B

32. 2A - 3B

33. 3A - 2B

34. 4A - 1B

**Semi Final Round:**

---

**Day 7**

---

35. L31 - L33

36. L32 - L34

37. W31 - W33

38. W32 - W34

**Final Round:**

---

**Day 8**

---

39. L35 - L36 (Winner 7th, Loser 8th)

40. W35 - W36 (Winner 5th, Loser 6th)

41. L37 - L38 (Winner 3rd, Loser 4th)

42. W37 - W 38 (Winner 1st, Loser 2nd)

---

Games 31 through 42 must be played to a conclusion, accordingly it may be necessary to apply Water Polo Rules relating to penalty shoot-out.

The Management Committee of World Aquatics Competitions may change the order and schedule of games to meet with the requirements of the Host Federation and/or television provided that at least twenty four (24) hours' notice is given.

**20.9.1.2 Olympic Games - Tournament - Women****20.9.1.2.1 Draw**

The Draw for the Olympic Games Tournament will be either on the last day of the Olympic Games Qualification Tournament – Women or as otherwise determined and the following principle shall apply: if a team is



already qualified by its ranking from a preceding qualification competition, the team will be placed on the highest line of the Draw according to that ranking and the team taking its place will be placed on the lower line.

a) **Group Draw**

For the Preliminary Round, all qualifying teams will be drawn by pairs into two groups, either A or B.

First Line, the first placed team from the previous World Championship and the first team from the preceding year's World League will be drawn, one into A, and one into B.

Second line, the teams representing the Continents of Europe and Oceania will be drawn, one into A, and one into B.

Third line, the first and second placed teams from the Olympic Games Qualification Tournament - Women will be drawn, one into A, and one into B.

Fourth line, the team representing the Continent of America and the team representing the Continent of Asia will be drawn, one into A, and one into B.

Fifth line, the team representing the Continent of Africa and the team representing the Host Country will be drawn, one into A, and one into B.

b) **Team Draw**

After being divided into Group A and Group B, the teams will then be drawn with each team in each group receiving a separate number from one (1) to five (5).

**20.9.1.2.2 Schedule of Games Preliminary Round**

Two (2) groups of five (5) teams form Group A and Group B and play a single round robin in each group.

Day 1	Day 2	Day 3	Day 4	Day 5
1. A5-A1	5. B1-B3	9. A5-A2	13. A2-A3	17. B3-B5
2. A2-A4	6. B4-B5	10. A3-A4	14. A4-A1	18. B1-B2
3. B5-B1	7. A4-A5	11. B3-B4	15. B2-B3	19. A3-A5
4. B2-B4	8. A1-A3	12. B5-B2	16. B4-B1	20. A1-A2

**Quarter Final Round**

The first, second, third and fourth placed teams in Group A and Group B form a Group D of eight (8) teams. Group D plays a modified single elimination format.

Games played in the Preliminary Round may be repeated in the Quarter Final, Semi Final or Final Round. All games played in Group D must be played so that a definite winner is declared. Accordingly, it may be necessary to apply the Water Polo Rules relating to penalty shoot-out.

Places 9 - 10

The teams ranked fifth in each group of the Preliminary Round shall be classified for places 9 - 10 according to the following criteria:

Win-loss record in their Preliminary Round group.

If both teams have the same win-loss record, the classification will be determined by goal average (goals scored divided by games played) taking into account the results of all games played in the respective group.





---

**Day 6**

---

21. 1A - 4B

22. 2A - 3B

23. 3A - 2B

24. 4A - 1B

**Semi Final Round**

---

**Day 7**

---

25. L21 - L23

26. L22 - L24

27. W21 - W23

28. W22 - W24

**Final Round**

---

**Day 8**

---

29. L25 - L26 (Winner 7th, Loser 8th)

30. W25 - W26 (Winner 5th, Loser 6th)

31. L27 - L28 (Winner 3rd, Loser 4th)

32. W27 - W28 (Winner 1st, Loser 2nd)

---

Games 21 through 32 must be played to a conclusion, accordingly it may be necessary to apply Water Polo Rules relating to penalty shoot- out.

The Management Committee of World Aquatics Competitions may change the order and schedule of games to meet with the requirements of the Host Federation and/or television provided that at least twenty four (24) hours' notice is given.

**20.9.1.3 World Aquatics Championship – Men****20.9.1.3.1 Draw**

The draw for the World Aquatics Championships Tournament will be made two (2) months prior to the commencement of the World Aquatics Championships Tournament and the following principle shall apply: if a team is already qualified by its ranking from a preceding qualification competition, the team will be placed on the highest line of the draw according to that ranking and the team taking its place will be placed on the lower line.

For the Preliminary Round, all qualifying teams will be drawn into four (4) groups: A, B, C or D.

First Line, the first, second, third and fourth qualified teams from the preceding World Cup or Olympic Games will be drawn one into A, one into B, one into C, and one into D.

Second Line, the qualified teams from the World League (or from the World Cup or Olympic Games if applicable), the first qualified team from the Americas and the first qualified team from Europe will be drawn one into A, one into B, one into C, and one into D.

Third, the second qualified team from the Americas, the second and third qualified teams from Europe and the qualified team from Oceania will be drawn one into A, one into B, one into C, and one into D.

Fourth, the qualified team from Africa, the first and second teams from Asia and the Host Country (if the Host Country has already been drawn, then the next ranked team from the World Cup or Olympic Games) will be drawn one into A, one into B, one into C, and one into D.



After being divided into Groups A, B, C, or D, the teams will then be drawn with each team in each group receiving a separate number from one (1) to four (4).

### 20.9.1.3.2 Schedule of Games Preliminary Round (First):

Four (4) groups of four (4) teams each from Group A, Group B, Group C and Group D play a single robin round in each group.

Day 1	Day 2	Day 3
1. A3 – A1	9. B4 – B3	17. C1 – C4
2. A2 – A4	10. B1 – B2	18. C2 – C3
3. B3 – B1	11. C4 – C3	19. D1 – D4
4. B2 – B4	12. C1 – C2	20. D2 – D3
5. C3 – C1	13. D4 – D3	21. A1 – A4
6. C2 – C4	14. D1 – D2	22. A2 – A3
7. D3 – D1	15. A4 – A3	23. B1 – B4
8. D2 – D4	16. A1 – A2	24. B2 – B3

### Preliminary Round (Second):

The first placed teams in Group A, Group B, Group C and Group D have a bye.

The second and third placed teams in Group A, Group B, Group C and Group D play against each other in a cross group format. The fourth placed teams in each of Group A, Group B, Group C and Group D form a new Group which consists of four (4) teams. They play for places 13 – 16 in a cross group format:

Day 4
25. 4A – 4B
26. 4C – 4D
27. 2A – 3B
28. 3A – 2B
29. 2C – 3D
30. 3C – 2D

### Quarter Final Round:

Day 5
31. Loser Game 25 – Loser Game 26 (Winner 15th, Loser 16th)
32. Winner Game 25 – Winner Game 26 (Winner 13th, Loser 14th)
33. Loser Game 27 – Loser Game 29
34. Loser Game 28 – Loser Game 30
35. 1A – Winner Game 29
36. 1B – Winner Game 30
37. 1C – Winner Game 27
38. 1D – Winner Game 28

### Semi-Final Round:



---

**Day 6**

---

- 39. Loser Game 33 - Loser Game (Winner 11th, Loser 12th)
- 40. Winner Game 33 - Winner Game 34 (Winner 9th, Loser 10th)
- 41. Loser Game 35 - Loser Game 36
- 42. Loser Game 37 - Loser Game 38
- 43. Winner Game 35 - Winner Game 36
- 44. Winner Game 37 - Winner Game 38

**Final Round:**

---

**Day 7**

---

- 45. Loser Game 41 - Loser Game (Winner 7th, Loser 8th)
- 46. Winner Game 41 - Winner Game 42 (Winner 5th, Loser 6th)
- 47. Loser Game 43 - Loser Game 44 (Winner 3rd, Loser 4th)
- 48. Winner Game 43 - Winner Game 44 (Winner 1st, Loser 2nd)

Games 25 through 48 must be played to a conclusion, accordingly it may be necessary to apply the Water Polo Rules relating to penalty shoot-out.

The Management Committee of World Aquatics Competitions may change the order and schedule of games to meet with the requirements of the Host Federation and/or television provided that at least twenty four (24) hours' notice is given.

**20.9.1.4 World Aquatics Championships - Women****20.9.1.4.1 Draw**

The draw for the World Aquatics Championships Tournament will be made two (2) months prior to the commencement of the World Championships Tournament and the following principle shall apply: if a team is already qualified by its ranking from a preceding qualification competition, the team will be placed on the highest line of the draw according to its ranking and the team taking its place will be placed on the lower line.

For the Preliminary Round, all qualifying teams will be drawn into four (4) groups: A, B, C or D.

First Line, the first, second, third and fourth qualified teams from the preceding World Cup or Olympic Games will be drawn one into A, one into B, one into C, and one into D.

Second Line, the qualified teams from the World League (or from the World Cup or Olympic Games if applicable), the first qualified team from the Americas and the first qualified team from Europe will be drawn one into A, one into B, one into C, and one into D.

Third Line, the second qualified team from the Americas, the second and third qualified teams from Europe and the qualified team from Oceania will be drawn one into A, one into B, one into C and one into D.

Fourth Line, the qualified team from Africa, the first and second teams from Asia and the Host Country (if the Host Country has already been

drawn, then the next ranked team from the World Cup or Olympic Games) will be drawn one into A, one into B, one into C, and one into D.

After being divided into Groups A, B, C, or D, the teams will then be drawn with each team in each group receiving a separate number from one (1) to four (4).

**20.9.1.4.2 Schedule of Games**

Schedule of Games as in Part Six, Appendix 9, Article 1.1.2.



The Management Committee of World Aquatics Competitions may change the order and schedule of games to meet with the requirements of the Host Federation and/or television provided that at least twenty four (24) hours' notice is given.

**20.9.1.5 Olympic Games Qualification Tournament - Men****20.9.1.5.1 Draw**

The draw for the Olympic Games Qualification Tournament will be made two (2) months or as otherwise determined prior to the commencement of the Olympic Games Qualification Tournament.

For the Preliminary Round, all qualifying teams will be drawn by pairs into two groups, either A or B.

First Line, the two highest placed teams from the previous World Championships.

Second Line, the next two highest placed teams from the previous World Championships.

Third Line, the next two highest placed teams from the previous World Championships.

Fourth Line, the next two highest placed teams from the previous World Championships.

Fifth Line, the remaining teams, if any, from the World Championships or the highest ranked teams from Europe and the next highest ranked teams from the Americas.

Sixth Line, the remaining teams, if any, being the next highest ranked team from the Americas, Asia or Europe and the next highest ranked team from the Americas, Asia or Europe.

Should there be no teams from the previous Championships to seed onto a Line then the highest ranked teams for Europe, Americas, Asia, Africa or Oceania if any, shall be drawn alternating between Group A and Group B.

After being divided into Group A and B, the teams will then be drawn with each team in each group receiving of separate number of 1 to 6.

**20.9.1.5.2 Schedule of Games**

Schedule of Games as in Part Six, Appendix 9, Article 1.1.2.

The Management Committee of World Aquatics Competitions may change the order and schedule of games to meet with the requirements of the Host Federation and/or television provided that at least twenty four (24) hours' notice is given.

**20.9.1.6 Olympic Games Qualification Tournament - Women****20.9.1.6.1 Draw**

The draw for the Olympic Games Qualification Tournament will be made two (2) months or as otherwise determined prior to the commencement of the Olympic Games Qualification Tournament.

For the Preliminary Round, all qualifying teams will be drawn by pairs into two groups, either A or B.

First Line, the two highest placed teams from the previous World Championships.

Second Line, the next two highest placed teams from the previous World Championships.

Third Line, the next two highest placed teams from the previous World Championships.

Fourth Line, the next two highest placed teams from the previous World Championships.

Fifth Line, the remaining teams, if any, from the World Championships and the highest ranked teams from Europe, Americas, Asia, Africa or Oceania.

Sixth Line, the remaining teams, if any, shall be drawn alternating between Groups A and B.

Should there be no teams from the previous Championships to seed onto a Line then the highest ranked teams for Europe, Americas, Asia, Africa or Oceania if any, shall be drawn alternating between Group A and Group B.

After being divided into Group A and Group B, the teams will then be drawn with each team in each group receiving of separate number of 1 to 6.

**20.9.1.6.2 Schedule of Games**

Schedule of Games as in Part Six, Appendix 9, Article 1.1.2.



The Management Committee of World Aquatics Competitions may change the order and schedule of games to meet with the requirements of the Host Federation and/or television provided that at least twenty four (24) hours' notice is given.

### **20.9.1.7 World U20 and U18 Championships – Men and Women**

#### **20.9.1.7.1 Draw**

The draw for the World U20 and U18 Championships will be made two (2) months prior to the commencement of the World Championships Tournament and the following principle shall apply: if a team is already qualified by its ranking from a preceding qualification competition, the team will be placed on the highest line of the draw according to its ranking and the team taking its place will be placed on the lower line.

Draw for twenty (20) Teams

The best 8 teams in the ranking from the previous World Championships (seeding) go in group A and B, and lower 12 teams in 4 groups C, D, E, and F.

#### **20.9.1.7.2 Schedule of Games**

Schedule for twenty (20) Teams

The best 8 teams in the ranking from the previous World Championships (seeding) go in group A and B, and lower 12 teams in 4 groups C, D, E, and F.

The numbers in the first 3 days are the position in the group after the draw. A and B groups have 4 teams and C, D, E, F groups have 3 teams.

First 3 days A and B group teams they play 3 games (round robin), while C, D, E, F they play 2 games (round robin).

The numbers from the day 4 are the ranking in the groups.

From the ranking of the groups C,D,E,F .the 2nd teams and the 3d teams of the groups C,D,E,F they play in 2 groups (G,H) a mixed round robin the days 4 to 6, and then 7and 8 days for places13-20. 1G-1H (13-14 place) 2G-2H (15-16), 3G-3H (17-18), 4G-4H (19-20).

Day 4, the first teams in the groups C,D,E,F they play against (1D- 1C, 1E-1F) and the losers cross with 3d teams in Group A and B, while the winners cross with 4th teams in Group A and B.

The day 6 the winners of the 4 games they cross with first and seconds of Groups A and B (quarter finals) while the 4 losers they play for 9-12 places the days 7 and 8.

The days 7 and 8 we have semifinals and finals (1- 4 places) and also ranking from 5 to 8 places

The teams will play at least 6 games in the 8 days schedule and for the teams from 13-20 places to be able to play also the 2 last days.

#### **Preliminary Round**

Four (4) groups of three (3) teams each from Group C, Group D, Group E and Group F play a single robin round in each group. Upon the result of the previous World Aquatics World Championships the top eight (8) teams will be drawn into two (2) group of fours (4), Group A and Group B.



<b>DAY 1</b>	<b>DAY 2</b>	<b>DAY 3</b>
1. C1-C3	9. D2-D3	17. E1-E2
2. D1-D3	10. E2-E3	18. F1-F2
3. E1-E3	11. F2-F3	19. C1-C2
4. F1-F3	12. C2-C3	20. D1-D2
5. A1-A3	13. B1-B2	21. A2-A3
6. B1-B3	14. A1-A2	22. B2-B3
7. A2-A4	15. B3-B4	23. A1-A4
8. B2-B4	16. A3-A4	24. B1-B4

Bye Day 1: C2 D2 E2 F2

Bye Day2 : C1 D1 E1 F1

Bye Day 3: C3 D3 E3 F3

**Cross Overs:**

The first placed teams in Group A, Group B have a bye.

<b>DAY 4</b>	<b>DAY 5</b>
25.2C-3D	31. 2E-2C
26.2E-3F	32. 3F-3D
27. 3C-2D	33. 3E-3C
28. 3E-2F	34. 2F-2D
29. 1D-1C	35. L29-3A
30. 1E-1F	36. L30-3B
	37. W29-4A
	38. W30-4B

Bye Day 4: A+B

Bye Day 5: 1A 2A 1B 2B

**Quarter Final Round, Semi-Final Round and Final Round**

<b>DAY 6</b>	<b>DAY 7</b>	<b>DAY 8</b>
39. 2C-3F	47. 4G-4H (19-20)	55. 2G-2H (15-16)
40. 2E-3D	48. 3G-3H (17-18)	56. 1G-1H (13-14)
41.3C-2F	49. L35-L38	57.L49-L50 (11-12)
42. 3E-2D	50.L36-L37	58. W49-W50 (9-10)
43. 1A-W38	51. L43-L46	59. L51-L52 (7-8)
44. 1B-W37	52. L44-L45	60. W51-W52 (5-6)
45. 2A-W36	53. W43-W46	61. L53-L54 (3-4)
46. 2B-W35	54. W44-W45	62. W53-W54 (1-2)

The Management Committee of World Aquatics Competitions may change the order and schedule of games to meet with the requirements of the Host Federation and/or television provided that at least twenty four (24) hours' notice is given.



GROUP A	GROUP B				
A1	B1	C1	D1	E1	F1
A2	B2	C2	D2	E2	F2
A3	B3	C3	D3	E3	F3
A4	B4				
1A	1B	1C	2C	3C	
2A	2B	1D	2D	3D	
3A	3B	1E	2E	3E	
4A	4B	1F	2F	3F	

DAY 4, 5, 6	
ROUND ROBIN	ROUND ROBIN
GROUP G	GROUP H
2C	3C
3D	2D
2E	3E
3E	2F

DAY 7,8 for places 13-20	
1G	1H
2G	2H
3G	3H
4G	4H

#### 20.9.1.7.3 Draw for Competitions

The Management Committee for World Aquatics Competitions has the authority if there are only thirteen (13) or fourteen (14) participating teams to draw teams into two (2) groups rather than being required to draw teams in the prescribed manner for a competition based upon sixteen (16) teams, namely for (4) groups of four (4) teams each.

#### 20.9.1.7.4 Order of Games

The Management Committee of World Aquatics Competitions may change the order and schedule of games to meet with requirements of the Host Federation and/or television provided that at least twenty four (24) hours' notice is given.

#### 20.9.1.7.5 Officials

The Management Committee of World Aquatics Competitions may in addition to other officials appoint the following to assist in the conduct of any competition, namely: a World Aquatics TWPC Delegate, a World Aquatics TWPC Evaluator(s) and Timeout Officials.

#### 20.9.1.8 World 16U Championships Men

##### 20.9.1.8.1 Draw

The draw for the World 16U Men will be made at least two (2) months prior to the commencement of the World Championships.

##### Draw for thirty-two (32) Teams:

The draw for the World 16U Men and will be made at least two (2) months prior to the commencement of the World Championships.

The 8 highest ranked teams from the previous 16U Men World Championships go to line 1. The rest of the teams from 9 to 32 place go to line 2.

##### 20.9.1.8.2 There will be 8 Groups A, B, C, D, E, F, G, H of 4 teams each from the 2 lines. **Schedule of Games**

Schedule for thirty-two (32) Teams

First 3 days all group teams A, B,C,D,E,F,G,H they play 3 games (round robin),

The numbers from day 4 are the ranking in the groups.



The day 4, from the ranking of all groups A,B,C,D,E,F,G,H the 1st teams and the 2nd teams (Division 1 - Division 2) they play as following:

1 A	vs	2 D
2 B	vs	1 C
2 C	vs	1 B
2 A	vs	1 D
1 E	vs	2 H
2 F	vs	1 G
1 F	vs	2 G
2 E	vs	1 H

From the ranking of all groups A,B,C,D,E,F,G,H the 3d teams and the 4th teams (Division 3 - Division 4) they play as following:

3A	vs	4D
4B	vs	3C
4C	vs	3B
4A	vs	3D
3E	vs	4H
4F	vs	3G
3F	vs	4G
4E	vs	3H

Day 5 (Quarter Finals), the winners of the games from day 4 between 1st and 2nd teams, (groups A,B,C,D,E,F,G,H) they play for division 1 (1st to 8th place) and the winners of the games from day 4 between 3d and 4th teams, (groups A,B,C,D,E,F,G,H) they play for division 3 (17th to 24th place) , while the losers of the games from day 4 between 1st and 2nd teams (groups A,B,C,D,E,F,G,H) they play for division 2 (9th to 16th place) and the losers of the games from day 4 between 3d and 4th teams (groups A,B,C,D,E,F,G,H) they play for division 4 (25th to 32nd place) .

The day 6, teams will play Semi Finals and day 7 teams will play, Finals (7th-8th, 5th- 6th, 4th-3d, 2nd-1st places) for its division.

The three winning teams in each Division will be awarded.





Group A		Group B		Group C		Group D		Group E		Group F		Group G		Group H	
A1	A3	B1	B3	C1	C3	D1	D3	E1	E3	F1	F3	G1	G3	H1	H3
A2	A4	B2	B4	C2	C4	D2	D4	E2	E4	F2	F4	G2	G4	H2	H4
A3	A2	B3	B2	C3	C2	D3	D2	E3	E2	F3	F2	G3	G2	H3	H2
A4	A1	B4	B1	C4	C1	D4	D1	E4	E1	F4	F1	G4	G1	H4	H1
A1	A2	B1	B2	C1	C2	D1	D2	E1	E2	F1	F2	G1	G2	H1	H2
A3	A4	B3	B4	C3	C4	D3	D4	E3	E4	F3	F4	G3	G4	H3	H4

DAY 1															
TIME	#	TEAM	TEAM					TIME	#	TEAM	TEAM				
9:00	#1	A1	A3	GROUP A B C D					#9	E1	E3	GROUP E F G H			
10:15	#2	A2	A4						#10	E2	E4				
11:30	#3	B1	B3						#11	F1	F3				
12:45	#4	B2	B4						#12	F2	F4				
	#5	C1	C3						#13	G1	G3				
	#6	C2	C4						#14	G2	G4				
	#7	D1	D3						#15	H1	H3				
	#8	D2	D4						#16	H2	H4				

DAY 2															
TIME	#	TEAM	TEAM					TIME	#	TEAM	TEAM				
9:00	#17	C3	C2	GROUP A B C D					#25	G3	G2	GROUP E F G H			
10:15	#18	C4	C1						#26	G4	G1				
11:30	#19	D3	D2						#27	H3	H2				
12:45	#20	D4	D1						#28	H4	H1				
	#21	A3	A2						#29	E3	E2				
	#22	A4	A1						#30	E4	E1				
	#23	B3	B2						#31	F3	F2				
	#24	B4	B1						#32	F4	F1				

DAY 3															
TIME	#	TEAM	TEAM					TIME	#	TEAM	TEAM				
9:00	#33	D1	D2	GROUP A B C D					#41	H1	H2	GROUP E F G H			
10:15	#34	D3	D4						#42	H3	H4				
11:30	#35	C1	C2						#43	G1	G2				
12:45	#36	C3	C4						#44	G3	G4				
	#37	B1	B2						#45	F1	F2				
	#38	B3	B4						#46	F3	F4				
	#39	A1	A2						#47	E1	E2				
	#40	A3	A4						#48	E3	E4				

GROUP A	GROUP B	GROUP C	GROUP D	GROUP E	GROUP F	GROUP G	GROUP H
1 A	1 B	1 C	1 D	1 E	1 F	1 G	1 H
2 A	2 B	2 C	2 D	2 E	2 F	2 G	2 H
3 A	3 B	3 C	3 D	3 E	3 F	3 G	3 H
4A	4B	4C	4 D	4E	4F	4G	4H

DAY 4						DAY 4					
TIME	#	TEAM	vs	TEAM		TIME	#	TEAM	vs	TEAM	
9:00	#49	1 A	vs	2 D	Division 1 and Division 2		#81	3A	vs	4D	Division 3 and Division 4
10:15	#50	2 B	vs	1 C			#82	4B	vs	3C	
11:30	#51	2 C	vs	1 B			#83	4C	vs	3B	
12:45	#52	2 A	vs	1 D			#84	4A	vs	3D	
	#53	1 E	vs	2 H			#85	3E	vs	4H	
	#54	2 F	vs	1 G			#86	4F	vs	3G	
	#55	1 F	vs	2 G			#87	3F	vs	4G	
	#56	2 E	vs	1 H			#88	4E	vs	3H	

DAY 5 (QUARTER FINALS)						DAY 5 (QUARTER FINALS)					
	#57	LG49	LG50		Division 2		#89	LG81	LG82		Division 4
	#58	LG51	LG52				#90	LG83	LG84		
	#59	LG 53	LG54				#91	LG85	LG86		
	#60	LG55	LG56				#92	LG87	LG88		
	#61	WG49	WG50		Division 1		#93	WG81	WG82	Division 3	
	#62	WG51	WG52				#94	WG83	WG84		
	#63	WG53	WG54				#95	WG85	WG86		
	#64	WG55	WG56				#96	WG87	WG88		

DAY 6 (SEMI FINALS)						DAY 6 (SEMI FINALS)					
	#65	LG57	LG58		Division 2		#97	LG89	LG90	Division 4	
	#66	LG59	LG60				#98	LG91	LG92		
	#67	WG57	WG58				#99	WG89	WG90		
	#68	WG59	WG60				#100	WG91	WG92		
	#69	LG61	LG62		Division 1		#101	LG93	LG94	Division 3	
	#70	LG63	LG64				#102	LG95	LG96		
	#71	WG61	WG62				#103	WG93	WG94		
	#72	WG63	WG64				#104	WG95	WG96		

DAY 7 (FINALS)						DAY 7 (FINALS)					
	#73	LG65	LG66	7-8th pl	Division 2/Gold		#105	LG97	LG98	7-8th pl	Division 4 /Bronze
	#74	WG65	WG66	5-6th pl			#106	WG97	WG98	5-6th pl	
	#75	LG67	LG68	Bronze M			#107	LG99	LG100	Bronze M	
	#76	WG67	WG66	Gold M			#108	WG99	WG100	Gold M	
	#77	LG69	LG70	7-8th pl	Division 1/Platinum		#109	LG101	LG102	7-8th pl	Division 3/Silver
	#78	WG69	WG70	5-6th pl			#110	WG101	WG102	5-6th pl	
	#79	LG71	LG72	Bronze M			#111	LG103	LG104	Bronze M	
	#80	WG71	WG72	Gold M			#112	WG103	WG104	Gold M	

**20.9.1.9 World 16U Championships Women**
**20.9.1.9.1 Draw**

The draw for the World 16U Women will be made at least two (2) months prior to the commencement of the World Championships

Draw for twenty-four (24) Teams

The highest ranked 8 teams from the previous 16U Women World Championships go to line 1 and from this line will be drawn the first teams in each one of eight groups. The rest of the 16 teams will go to line 2 and the first 8 drawn teams will go as second in each one of the eight groups, while the last eight drawn teams will go as third in each one of the eight groups.

There will be 8 Groups A,B,C,D,E,F,G,H of 3 teams each from the 2 lines.

**20.9.1.9.2 Schedule of Games**

Schedule for twenty-four (24) Teams

First 3 days all group teams A, B,C,D,E,F,G,H they play 2 games (round robin).

The numbers from day 4 are the ranking in the groups.

The day 4, from the ranking of all groups A, B, C, D, E, F, G, H the 1st teams and the 2nd teams (Division 1 - Division 2) they play as following:

1 A	vs	2 D
2 B	vs	1 C
2 C	vs	1 B
2 A	vs	1 D
1 E	vs	2 H
2 F	vs	1 G
1 F	vs	2 G
2 E	vs	1 H

From the ranking of all groups A,B,C,D,E,F,G,H the 3rd teams (Division 3) they play Quarter Finals as following:

3A	vs	3D
3B	vs	3C
3E	vs	3H
3F	vs	3G

Day 5 (Quarter Finals), the winners of the games from day 4 between 1st and 2nd teams, (groups A,B,C,D,E,F,G,H) they play for division 1 (1st to 8th place), while the losers of the games from day 4 between 1st and 2nd teams, (groups A,B,C,D,E,F,G,H) they play for division 2 (9th to 16th place).

Division 3 the day 5, they will play Semi Finals.

The day 6, teams of Division 1 and Division 2 will play Semi Finals and teams of Division 3 will play Finals (7th-8th, 5th- 6th, 4th-3d, 2nd-1st places).

The day 7 teams of Division 1 and Division 2 will play, Finals (7th-8th, 5th- 6th, 4th-3d, 2nd-1st places) for its division.



Group A		Group B		Group C		Group D		Group E		Group F		Group G		Group H			
A1	A3	B1	B3	C1	C3	D1	D3	E1	E3	F1	F3	G1	G3	H1	H3		
A2	Bye	B2	Bye	C2	Bye	D2	Bye	E2	Bye	F2	Bye	G2	Bye	H2	Bye		
A3	A2	B3	B2	C3	C2	D3	D2	E3	E2	F3	F2	G3	G2	H3	H2		
Bye	A1	Bye	B1	Bye	C1	Bye	D1	Bye	E1	Bye	F1	Bye	G1	Bye	H1		
A1	A2	B1	B2	C1	C2	D1	D2	E1	E2	F1	F2	G1	G2	H1	H2		
A3	Bye	B3	Bye	C3	Bye	D3	Bye	E3	Bye	F3	Bye	G3	Bye	H3	Bye		
<b>DAY 1</b>																	
TIME	#	TEAM	TEAM	GROUP A B C D				TIME	#	TEAM	TEAM	GROUP E F G H					
9:00	#1	A1	A3					#5	E1	E3							
10:15	#2	B1	B3					#6	F1	F3							
11:30	#3	C1	C3					#7	G1	G3							
12:45	#4	D1	D3					#8	H1	H3							
<b>DAY 2</b>																	
TIME	#	TEAM	TEAM	GROUP A B C D				TIME	#	TEAM	TEAM	GROUP E F G H					
9:00	#9	C3	C2					#13	G3	G2							
10:15	#10	D3	D2					#14	H3	H2							
11:30	#11	A3	A2					#15	E3	E2							
12:45	#12	B3	B2					#16	F3	F2							
<b>DAY 3</b>																	
TIME	#	TEAM	TEAM	GROUP A B C D				TIME	#	TEAM	TEAM	GROUP E F G H					
9:00	#17	D1	D2					#21	H1	H2							
10:15	#18	C1	C2					#22	G1	G2							
11:30	#19	B1	B2					#23	F1	F2							
12:45	#20	A1	A2					#24	E1	E2							
GROUP A	GROUP B	GROUP C	GROUP D	GROUP E	GROUP F	GROUP G	GROUP H										
1 A	1 B	1 C	1 D	1 E	1 F	1 G	1 H										
2 A	2 B	2 C	2 D	2 E	2 F	2 G	2 H										
3 A	3 B	3 C	3 D	3 E	3 F	3 G	3 H										
<b>DAY 4</b>								<b>DAY 4 (QUARTER FINALS)</b>									
TIME	#	TEAM	vs	TEAM	Division 1 and Division 2				TIME	#	TEAM	vs	TEAM	Division 3			
9:00	#25	1 A	vs	2 D					#57	3A	vs	3D					
10:15	#26	2 B	vs	1 C					#58	3B	vs	3C					
11:30	#27	2 C	vs	1 B					#59	3E	vs	3H					
12:45	#28	2 A	vs	1 D					#60	3F	vs	3G					
	#29	1 E	vs	2 H													
	#30	2 F	vs	1 G													
	#31	1 F	vs	2 G													
	#32	2 E	vs	1 H													
<b>DAY 5 (QUARTER FINALS)</b>								<b>DAY 5 (SEMI FINALS)</b>									
	#33	LG25	LG26	Division 2					#61	LG57	LG58	Division 3					
	#34	LG27	LG28					#62	LG59	LG60							
	#35	LG 29	LG30					#63	WG57	WG58							
	#36	LG31	LG32					#64	WG59	WG60							
	#37	WG25	WG26														
	#38	WG27	WG28	Division 1													
	#39	WG29	WG30														
	#40	WG31	WG32														
<b>DAY 6 (SEMI FINALS)</b>								<b>DAY 6 (FINALS)</b>									
	#41	LG33	LG34	Division 2					#65	LG61	LG62	7-8th pl	Division 3/Silver				
	#42	LG35	LG36					#66	WG61	WG62	5-6th pl						
	#43	WG33	WG34					#67	LG63	LG64	Bronze M						
	#44	WG35	WG36					#68	WG63	WG64	Gold M						
	#45	LG37	LG38	Division 1													
	#46	LG39	LG40														
	#47	WG37	WG38														
	#48	WG39	WG40														
<b>DAY 7 (FINALS)</b>								<b>DAY 7 (0)</b>									
	#49	LG41	LG42	7-8th pl	Division 2/Gold												
	#50	WG41	WG42	5-6th pl													
	#51	LG43	LG44	Bronze M													
	#52	WG43	WG44	Gold M													
	#53	LG45	LG46	7-8th pl	Division 1/Platinum												
	#54	WG45	WG46	5-6th pl													
	#55	LG47	LG48	Bronze M													
	#56	WG47	WG48	Gold M													

**20.9.1.10 Further regulation to World 16U Championships Women and Men****20.9.1.10.1 Specific Rules**

The top three winning teams in each Division will be awarded. The winner of Division 1 receives the World Champion title, gold medals and trophy.

The competition field is 25,00 X 20,00 m, the game duration 4 periods of 6 minutes. World Aquatics may consider having 4 periods of 8 min from day 5 Quarter Finals and till the end of the tournament only for Division 1. The ball will be Size 4 for the women's and size 5 for the men's tournament.

All other World Aquatics Water polo rules apply.

**20.9.1.10.2 Order of Games**

The Management Committee of World Aquatics Competitions may change the order and schedule of games to meet with requirements of the Host Federation and/or television provided that at least twenty-four (24) hours' notice is given.

**20.9.1.10.3 Officials**

Each participating team is financially responsible for one officiating referee appointed by AQUA at the Event. The Management Committee of World Aquatics Competitions may in addition to other officials appoint the following to assist in the conduct of any competition, namely: a World Aquatics TWPC Delegate, a World Aquatics TWPC Evaluator(s) and Timeout Officials.

**20.9.1.11 TIE BREAKING RULES****General**

All matches shall be played in accordance with the World Aquatics' current Competition Rules. Variations on a technical level are possible.

Each game must have a winner. If a game ends with a tie in regular time, the teams must go into a penalty shoot-out according to the Rules.

The matches shall be scored as follows:

- a) win in regular time = 3 points
- b) win after penalty shootout = 2 points
- c) loss after penalty shootout = 1 point
- d) loss in regular = 0 point

Teams' rankings are obtained by adding up the number of points won.

**20.9.1.11.1 Tie Breaking Rules, Group phase or Round Robin Tournaments****20.9.1.11.1.1** If two (2) teams shall have equal points, further classification shall be established as follows:

The team winning the game between them (including penalty shoot-out if any) shall be placed higher.

If there is more than one tie in a group, the highest placed tie shall be determined first.

**20.9.1.11.1.2** If three (3) or more teams shall have equal points, further classification shall be established as follows:

The results among the tied teams shall determine which team is placed higher.

**The comparison shall be made:**

first, upon the points of the games among the tied teams.

second, the goal difference (excluding the goals from penalty shoot-out) among the tied teams,

third, based upon goals scored among tied teams.

If still tied, the games played against the highest placed team (or teams, if tied, the team or teams not involved in the tie) shall be considered.

The first comparison shall be based on goal difference, and if still tied, then based on goals scored.



If still tied, the results against the next highest placed team (or teams, if tied) shall be used in succession until all results have been considered.

If still tied, and there is no practical manner to determine the ranking, the final classification between the teams in the tie shall be decided by coin-toss.

If there is more than one tie in a group, the highest placed tie shall be determined first.

For the purpose of calculating either goal difference or goals scored, the goals in any penalty shoot-out will not be taken into consideration.

**20.10 APPENDIX 10 – PROTOCOL FOR COACH'S CHALLENGE****Procedures:**

Each Coach is entitled to challenge one (1) call, made by a referee, per match (a "Coaches' Challenge"), so long as the challenge is one of the following:

1. A Referee's perceived failure to call a violent action;
2. A Referee's perceived failure to call a penalty foul;
3. A Referee's perceived incorrect call of a penalty foul; or
4. One of the following field of play situations not reviewed by VAR technology:
  - a. A corner throw or goal throw.
  - b. A goal.
  - c. A declaration of no goal.
  - d. An interference in an Athlete's penalty throw.
  - e. A goal recorded at "shot clock" expiration or at the conclusion of a period.
  - f. An Athlete's improper or illegal entry or re-entry into the field of play.
  - g. A shot taken at the end of a period, during which time, a player is wrongfully excluded from the field of play.
  - h. Any perceived error made by the jury table; or
  - i. Any perceived electronic error that has not been reviewed by VAR.

For the avoidance of doubt, a Coach may not challenge a decision for which a referee has consulted a VAR review.

If a Coach's Challenge is successful, he/she is entitled to make a second challenge, in the same match, subject to the same criteria as set out above.

In the event a team makes a challenge that is not allowed pursuant to the aforementioned guidelines during stoppage as timeout, goal, intervals between periods, before the taking of a penalty throw, or any other stoppage, the coach shall be sanctioned by a yellow card or red card if yellow was already given before. If the head coach has already been excluded, any other bench official can only receive a red card.

**Timing:**

The timing of a Coach's Challenge must comply with the following criteria:

1. Challenge against an uncalled violent action: The challenge must be brought immediately upon the challenging team's ball possession, and not afterwards.
2. Challenge against a penalty foul: The challenge must be made by the team against which the penalty foul has been called before the penalty throw is taken.
3. Challenge against an uncalled penalty foul: The challenge must be made on the earliest occurrence of one of the following moments:
  - Upon the challenging team's immediate next ball possession, but not afterwards.
  - At a timeout called by the non-challenging team before the challenging team's next immediate ball possession, but not afterwards.
  - At a corner throw in favor of the non-challenging team before the challenging team's immediate next ball possession, but not afterwards.
  - At a penalty foul call in favor of the non-challenging team before the challenging team's immediate next possession and before it is taken, but not afterwards.
  - When the non-challenging team scores at its immediately following possession, but not afterwards.
  - When the referees stop the game and take the ball for any reason during the non-challenging team's next immediate possession.



Against a goal scored at "shot clock" expiration or at the end of a period: The challenge must be made instantaneously following such shot.

Against all other cases:

The challenge must be made by the challenging team upon the earliest occurrence of the following moments:

- Upon the challenging team's immediate next ball possession, but not afterwards.
- At a timeout called by the non-challenging team before the challenging team's next immediate ball possession, but not afterwards.
- At a corner throw in favor of the non-challenging team before the challenging team's immediate next ball possession, but not afterwards.
- At a penalty foul call in favor of the non-challenging team before the challenging team's immediate next possession and before it is taken, but not afterwards.
- When the non-challenging team scores on the challenging team, immediately upon the challenging team's possession, but not afterwards.
- When the referees stop the game and take the ball for any reason during the non-challenging team's next immediate possession.

For the avoidance of doubt, if a Coach's Challenge is lost, the challenging team shall lose the right to make any further challenges for the remainder of the match.

**Signaling a Coach's Challenge:**

- A Coach (head coach or assistant coach) must press the timeout button (or use a horn) to signal the challenge. The Coach must also signal with a green flag or by making the VAR square-signal (the motion of creating a square with one's index fingers) to indicate "review" of his/her challenge.
- When a Coach's Challenge is made, the referee and the delegate(s) must go to the VAR-referee to review the subject matter of the challenge. The VAR-referee, after rendering a final decision, shall go to the half-distance line of the field of play to announce the decision.

If the Coach's Challenge is rejected:

- The match continues from the time at which the game was stopped by the challenge in case if the result of a challenge for violent action a yellow card for simulation for the challenging team. There will be no consequences for either team.
- If the case is determined to be a simulation, as defined in section 19.17 of the Competition Regulations, as a result of a challenge made for a suspected violent action, the referee shall use the protocol for simulations, and the game shall restart with a free throw awarded to the non-challenging team at the time when the simulation occurred.

If the Coach's Challenge is accepted:

- In the case of a violent action, the time of the match is reset to the moment at which the violent action or misconduct occurred, and the referees shall follow the protocol for the violent action or misconduct as the case may be.
- In the case of a penalty foul that has been cancelled as a result of the Coach's Challenge, the game will restart from the time at which the penalty foul was called. The penalty foul called on that occasion shall be nullified and the referees shall change the call in accordance with Water Polo rules in the following manners.
- If fouls other than the penalty foul are determined to have taken place, the referees shall act in accordance with the Water Polo rules.
- In the case of an uncalled penalty foul that has been reviewed and determined to be a penalty foul, the match time shall reset to the time at which the penalty foul should have been called, and the Referees shall implement the penalty foul protocol procedures.
- In the case of a challenge determining that a corner throw or goal throw should have taken place, the match time shall reset to the time at which the corner throw or goal throw should have occurred.



While a Coach's Challenge is being reviewed via VAR, both teams may substitute their players from any of the reentry areas before the VAR-referee communicates the final decision.

All goals, personal fouls, and timeouts that occurred during the time that has been recredited to the clock (due to a successful Coach's Challenge) are nullified. However, yellow cards, red cards, violent actions and misconducts will remain on the game protocol.





WORLD  
AQUATICS

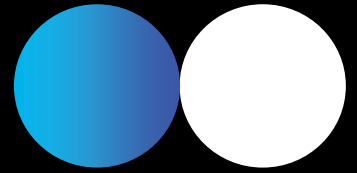

# ARTISTIC SWIMMING

COMPETITION  
REGULATIONS

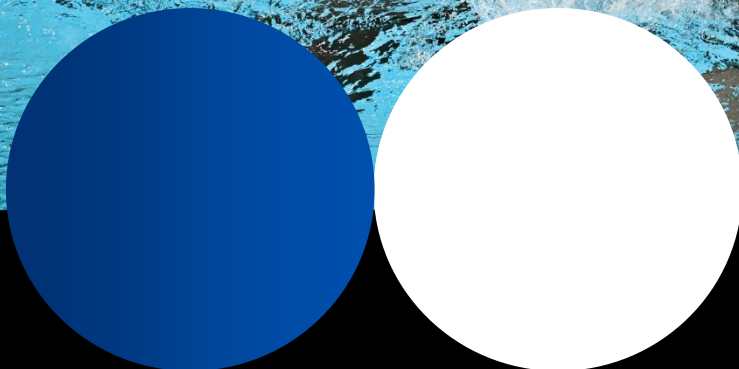



## TABLE OF CONTENTS

### PART SEVEN: ARTISTIC SWIMMING RULES

<b>PART SEVEN: ARTISTIC SWIMMING RULES</b> .....	<b>291</b>
<b>1</b> GENERAL.....	<b>291</b>
<b>2</b> COMPETITIONS.....	<b>291</b>
<b>3</b> ELIGIBILITY.....	<b>291</b>
<b>4</b> SESSIONS.....	<b>291</b>
<b>5</b> PROGRAMS.....	<b>292</b>
<b>6</b> ENTRIES.....	<b>293</b>
<b>7</b> PRELIMINARIES AND FINALS.....	<b>294</b>
<b>8</b> FIGURE SESSIONS.....	<b>294</b>
<b>9</b> FIGURE PANELS.....	<b>295</b>
<b>10</b> JUDGEMENT OF FIGURES.....	<b>295</b>
<b>11</b> PENALTIES IN FIGURE SESSION.....	<b>295</b>
<b>12</b> CALCULATION OF THE FIGURE RESULT.....	<b>296</b>
<b>13</b> ROUTINE SESSIONS.....	<b>296</b>
<b>14</b> TIME LIMITS FOR ROUTINES.....	<b>298</b>
<b>15</b> MUSIC ACCOMPANIMENTS.....	<b>298</b>
<b>16</b> ROUTINE PANELS.....	<b>299</b>
<b>17</b> JUDGEMENT OF ROUTINES.....	<b>300</b>
<b>18</b> DEDUCTION, PENALTIES AND OTHER MATTERS IN ROUTINES.....	<b>300</b>
<b>19</b> CALCULATION OF THE ROUTINE RESULTS.....	<b>313</b>
<b>20</b> FINAL RESULT.....	<b>313</b>
<b>21</b> OFFICIALS AND DUTIES.....	<b>314</b>
<b>22</b> REFEREE.....	<b>315</b>
<b>23</b> OTHER OFFICIALS.....	<b>315</b>
<b>24</b> DUTIES OF ORGANIZER.....	<b>315</b>
<b>25</b> AGE GROUP RULES.....	<b>317</b>
<b>26</b> SWIMWEAR AND WEARABLES.....	<b>318</b>
<b>27</b> ARTISTIC SWIMMING FACILITIES AND EQUIPMENT.....	<b>318</b>
<b>28</b> MEDICAL AND SAFETY SPECIFIC REQUIREMENT FOR ARTISTIC SWIMMING.....	<b>323</b>
<b>29</b> APPENDICES.....	<b>324</b>
29.1 Appendix 1 - World Aquatics Basic Position, Basic Movement and Figures.....	<b>325</b>
29.2 Appendix 2 - Technical Routines.....	<b>350</b>
29.3 APPENDIX 3 - Set Numbers of Elements for Routines.....	<b>366</b>
29.4 APPENDIX 4 - REQUIRED ELEMENTS FOR ACROBATIC ROUTINE.....	<b>369</b>
29.5 APPENDIX 5 - REQUIRED ELEMENTS FOR THE FREE COMBINATION.....	<b>370</b>
29.6 APPENDIX 6 - HYBRID CATALOGUE.....	<b>372</b>
29.7 APPENDIX 7 - ACROBATICS CATALOGUE.....	<b>403</b>
29.8 APPENDIX 8 - IDENTIFICATION OF SYNCHRONISATION ERRORS.....	<b>498</b>
29.9 APPENDIX 9 - ARTISTIC SWIMMING WORLD RANKING.....	<b>503</b>



## PART SEVEN: ARTISTIC SWIMMING RULES

### 1 GENERAL

All international Artistic Swimming competitions shall be held under World Aquatics Competition Regulations.

### 2 COMPETITIONS

#### 2.1 Events

The events of Artistic Swimming are Women Solo, Men Solo, Women Duet, Mixed Duet, Open Team, Open Free Combination and Open Acrobatic Routine.

#### 2.2 World Aquatics Championships and Olympic Games Event

##### 2.2.1 Olympic Games

###### Women

Duet Technical Routine, Duet Free Routine

###### Open

Team Technical Routine, Team Free Routine, Team Acrobatic Routine

##### 2.2.2 World Aquatics Championships

##### 2.2.2.1 Artistic Swimming - World Aquatics Championships & World Aquatics Junior Championships

###### Women

Solo Technical Routine, Solo Free Routine, Duet Technical Routine, Duet Free Routine

###### Men

Solo Technical Routine, Solo Free Routine

###### Open

Team Technical Routine, Team Free Routine, Team Acrobatic Routine,

###### Mixed

Mixed Duet Technical Routine, Mixed Duet Free Routine

#### 2.3 World Aquatics Youth Artistic Swimming Championships

##### 2.3.1 Sessions

Women Solo, Men Solo, Women Duet, Mixed Duet, Team Free, Free Combination and Figures.

### 3 ELIGIBILITY

Athletes in Artistic Swimming younger than fifteen (15) years of age (on December 31st on the year of the competition) shall not be permitted to compete at the Olympic Games, World Aquatics Championships and Artistic Swimming World Cup.

### 4 SESSIONS

#### 4.1 Figures

Each athlete in Women Solo, Men Solo, Women Duet, Mixed Duet, and Open Team must perform four (4) or two (2) figures, according to the age group category, as described in the Part Seven, Appendix 1 of these Regulations.



Each athlete in Open Free Combination may perform figures as described in Part Seven, Appendix 1 of these Regulations.

The Age Group Figures are selected by the Technical Artistic Swimming Committee (TASC) every four (4) years, subject to approval by the World Aquatics Bureau. World Aquatics reserves their right to make any changes if deemed necessary.

#### **4.2 Technical Routine: Preliminaries / Finals**

The Technical Team Routine has four (4) to eight (8) athletes (for the exceptions see Part Seven, Article 6.2). In the Technical Routine each Women Solo, Men Solo, Women Duet, Mixed Duet, and Open Team must perform the Technical Required Elements described in Appendix 2 of this Part, a predetermined number of Elements (Hybrids and Acrobatics), and a free choice of Transitions (see Appendix 3 of these Regulations).

The Technical Required Elements and the number of Elements for each event are selected by the TASC every four (4) years, subject to approval by the World Aquatics Bureau. World Aquatics reserves their right to make any changes if deemed necessary.

The Routines are choreographed to music.

#### **4.3 Free Routine: Preliminaries / Finals**

The Free Team Routine has four (4) to eight (8) athletes (for the exceptions see Part Seven, Article 6.2). Each Free Women Solo, Men Solo, Women Duet, Mixed Duet, and Team Routine will consist of a predetermined number of Elements (Hybrids and Acrobatics) and a free choice of Transitions (see Appendix 3 of these regulations).

The number of Elements for each event will be selected by the TASC every four (4) years, subject to approval by the World Aquatics Bureau. World Aquatics reserves their right to make any changes if deemed necessary.

The routines are choreographed to music.

#### **4.4 Free Combination: Preliminary / Final**

The Free Combination has four (4) to ten (10) athletes who make a combination of routines.

The Open Free Combination has a predetermined number of Elements choreographed to music (see Part Seven, Appendix 3 of these Regulations).

The Routines are choreographed to music.

#### **4.5 Acrobatic Routine: Preliminary / Final**

The Acrobatic Routine has four (4) to eight (8) athletes.

The Acrobatic Routine has a predetermined number of Elements as described in Part Seven, Appendix 3 of these Regulations.

The Routines are choreographed to music.

## **5 PROGRAMS**

### **5.1 For Olympic Games**

The Olympic programme is confirmed by World Aquatics.

### **5.2 For World Championships**

Technical Routine Preliminary, Technical Routine Final, Free Routine Preliminary, Acrobatic Routine Preliminary, Free Routine Finals and Acrobatic Routine Final. (Time limits as listed in Part Seven, Article 14).

### **5.3 For Artistic Swimming World Cup**

Technical Routine Final, Free Routine Final and Acrobatic Routine Final (Time limits as listed in Part Seven, Article 14). The final order of sessions shall be determined by World Aquatics and the Organising Committee.).

### **5.4 For World Aquatics Junior Artistic Swimming Championships**



Preliminaries will be held for: Women Solo Free, Women Duet Free and Open Team Free. All other events are direct finals (time limits as listed in Part Seven, Article 14). The final order of sessions shall be determined by World Aquatics and the Organising Committee.

#### **5.5 For World Aquatics Youth Artistic Swimming Championships**

Figures and Free Routines in this order: Free Routine Preliminary, Free Combination Preliminary, Figures, Free Routine Final and Free Combination Final (Time limits as listed in ASAG 5). The final order of sessions shall be determined by World Aquatics and the Organising Committee.

#### **5.6 For all other international competitions**

The programme may be any combination of Part Seven, Article 4.1 – 4.3 so that the Free Routine is included. The Open Free Combination is for Youth and 12 & under. The Acrobatic Routine is for Senior and Junior.

## **6 ENTRIES**

**6.1** For World Aquatics competitions each country shall be entitled to enter one Women Solo Technical, one Women Solo Free, one Men Solo Technical, one Men Solo Free, one Women Duet Technical, one Women Duet Free, one Mixed Duet Technical, one Mixed Duet Free, one Open Technical Team, one Open Free Team and one Open Acrobatic Routine.

**6.1.1** In World Aquatics Championships each country shall be entitled to enter one Women Solo Technical, one Women Solo Free, one Men Solo Technical, one Men Solo Free, one Women Duet Technical, one Women Duet Free, one Mixed Duet Technical, one Mixed Duet Free, one Open Technical Team, one Open Free Team and one Open Acrobatic Routine.

**6.1.2** In World Aquatics Junior Championships each country shall be entitled to enter one Women Solo Technical, one Women Solo Free, one Men Solo Technical, one Men Solo Free, one Women Duet Technical, one Women Duet Free, one Mixed Duet Technical, one Mixed Duet Free, one Open Technical Team, one Open Free Team and one Open Acrobatic Routine.

**6.1.3** In World Aquatics Youth Championships and World Aquatics competitions each country shall be entitled to enter one Women Solo, one Men Solo, one Women Duet, one Mixed Duet, one Open Team and one Open Free Combination.

**6.1.4** In the World Aquatics World Cups, more than one Women Solo, more than one Men Solo, more than one Women Duet, more than one Mixed Duet, more than one Open Team, and more than one Open Acrobatic Routine shall be allowed in accordance with these Regulations.

**6.1.5** No changes to the entries will be accepted after the GMS sport entries deadline unless on medical grounds. A medical report must be sent to the World Aquatics Office and will be reviewed for approval by the World Aquatics Sports Medicine Committee. A 500.- USD fine will be applied for any non- medical changes after the deadline.

#### **6.2 Open Team, Open Free Combination and Open Acrobatic Routines:**

**6.2.1** For Olympic Games, Team routines shall consist of eight (8) athletes. The total number of athletes entered by each Federation (unless otherwise specified) may not exceed nine (9) athletes one as reserve. The total number of athletes may include a maximum of two (2) male athletes.

**6.2.2** For World Aquatics Championships and World Aquatics Junior Artistic Swimming Championships, Team routines shall consist of four (4) but may not exceed eight (8) athletes and a maximum of two (2) reserves. The total number of athletes may include a maximum of two (2) male athletes.

**6.2.3** For World Aquatics Youth Artistic Swimming Championships, Team routines shall consist of at least four (4) but not more than eight (8) athletes and Open Free Routine Combination shall consist of at least four (4) but may not exceed ten (10) athletes and a maximum of two (2) reserves. The total number of athletes may include a maximum of two (2) male athletes.

**6.3** Sport Entries for each event entered and corresponding Music Information sheets must be submitted in the relevant system and/or platform at least fourteen (14) days prior to the start of the competition. After this date, changes in sport entries will only be accepted on medical grounds. Coach Cards of declared difficulty for each event entered must be submitted electronically by the deadline and method as stated in the information bulletin/summons.



During competition time, changes to Coach Cards are to be made by **18h local time the day prior to each session, or a time to be determined by World Aquatics in accordance with the schedule.** No changes are possible after this deadline.

- 6.3.1** The entry shall designate the names of the Women Solo competitor and the reserve, the names of the Men Solo competitor and the reserve, the names of the Women Duet competitors and maximum of one reserve, the names of the Mixed Duet competitors and maximum of two reserve, the names of Open Team competitors and maximum two reserves, the names of Open Free Combination competitors and maximum two reserves and/or the names of the Open Acrobatic Routine competitors and maximum two reserves.

For World Aquatics Championships: The names of the Women Technical Solo competitor and the reserve, the names of the Women Solo Free competitor and the reserve, the names of the Men Solo Technical competitor and the reserve, the names of the Men Solo Free competitor and the reserve, the names of the Women Duet Technical competitors and maximum one reserve, the names of the Women Duet Free competitors and maximum one reserve, the names of the Mixed Duet Technical competitors and maximum two reserves, the names of the Mixed Duet Free competitors and maximum two reserves, the names of the Open Team Technical competitors and maximum of two reserves, the names of the Open Team Free competitors and maximum of two reserves, and the names of the Open Acrobatic Routine competitors and maximum of two reserves.

For World Aquatics Artistic Swimming World Cup please see Part Seven, Article 6.1.4 and 6.3.1.

## **7 PRELIMINARIES AND FINALS**

- 7.1** If there are more than twelve (12) entries in any Technical or Free Routine, Open Free Combination, or Open Acrobatic Routine, preliminaries may be held. Only the twelve (12) best results shall be allowed in the official finals.
- 7.2** If there are less than thirteen (13) entries in any Technical and Free Routine, Open Free Combination, or Open Acrobatic Routine, preliminaries may be held.
- 7.3** This information must be included on the information bulletin (see Part Seven, Article 24.3.7).

## **8 FIGURE SESSIONS**

- 8.1** Only one Figure session shall be held.
- 8.2** Athletes in competitions other than World Youth Championships, World Aquatics competitions and continental Championships may, by mutual consent, choose from the Age Group figures (see Part Seven, Appendix 1) for the level of ability of the athletes entered in the competition.

### **8.3 For the Figure session:**

In the 12 and under-age category each competitor in Women Solo, Men Solo, Women Duet, Mixed Duet, and Open Team must perform four (4) figures from the list as described in Appendix 1 of these rules. Each competitor in 12 and under Open Free Combination may perform four (4) figures selected by the above-described procedure.

In the Youth category each competitor in Women Solo, Men Solo, Women Duet, Mixed Duet, and Open Team must perform a group of two (2) figures from the Section (A, B or C) of figures drawn from the list described in Part Seven, Appendix 1 of these Regulations..

Each competitor in Youth Free Combination may perform the two (2) figures selected by the above-described procedure.

- 8.3.1** Figure section and groups from the World Aquatics Figures 2022–2025 in Part Seven, Appendix 1 shall be drawn by the Referee/TASC.
- 8.3.2** The draws shall be made eighteen (18) to seventy-two (72) hours before the start of the Figure session.
- 8.3.3** The draw shall be public. Place and time shall be announced at least twenty-four (24) hours in advance. Draws can be done over a social media platform.



**8.4** In the 12 and Under- category the order of appearance and the figures to be performed by each athlete shall be decided by lot. The Optional group shall be drawn first, then the order of appearance shall be drawn.

In the Youth category, the Figure section (A, B or C) shall be drawn first, then the order of appearance shall be drawn. The order of appearance draw list will be divided into two equal groups - 1 and 2 (if numbers are not equal, group 1 will have 1 extra athlete). Then one of the two figure groups of the drawn section will be assigned by lot to each athlete group (1 and 2). For example, if Section B is drawn, athlete group 1 may have group 4 drawn, and athlete group 2 may have group 3 drawn.

**8.4.1** Each group will have a separate ranking. The two rankings will not be combined.

**8.5** Swimwear for the figure session must be according to Part One, Article 7. It shall be black, and athletes shall wear white caps. Goggles and nose clips may be worn. Only small stud jewellery is permitted. Athletes must remove any dangling jewellery prior to the start of the event.

## 9 FIGURE PANELS

**9.1** When qualified judges are available in sufficient numbers one (1), two (2) or four (4) panels of four (4) to six (6) judges may officiate.

**9.1.1** When one (1) panel of judges is used, all athletes shall perform the four (4) or two (2) figures (according to age category) one by one in the listed order.

**9.1.2** When two (2) panels of judges are officiating, each panel shall judge one (1) or two (2) figures.

**9.1.3** When four (4) panels of judges are officiating, each panel shall judge one (1) figure.

**9.2** During the Figure session, the judges shall be placed in such elevated positions as to have a profile view of the athletes.

**9.2.1** All figures and judging shall commence at a signal from the Referee or Assistant Referee.

**9.2.2** On a signal from the Referee or Assistant Referee all judges shall simultaneously flash their score.

**9.2.3** Judges scores may only be flashed on the score board or be sent to the computer after approval by the Referee or the appointed official.

## 10 JUDGEMENT OF FIGURES

**10.1** The athlete can obtain points from 0 – 10 using 1/10th points.

<b>Perfect</b>	10	<b>Satisfactory</b>	5.9 – 5.0
<b>Near perfect</b>	9.9 – 9.5	<b>Deficient</b>	4.9 – 4.0
<b>Excellent</b>	9.4 – 9.0	<b>Weak</b>	3.9 – 3.0
<b>Very Good</b>	8.9 – 8.0	<b>Very weak</b>	2.9 – 2.0
<b>Good</b>	7.9 – 7.0	<b>Hardly recognizable</b>	1.9 – 0.1
<b>Competent</b>	6.9 – 6.0	<b>Completely failed</b>	0

**10.2** All judgements are made from the standpoint of perfection considering design and control, with each transition of the figure having a numerical value (NVT) based on its difficulty.

**10.3** If a judge by reason of illness or other unforeseen circumstances has made no award for any one figure, the average of the awards of the judges shall be computed and shall be considered as that of the missing award. This shall be calculated to the nearest 0.1 point.

## 11 PENALTIES IN FIGURE SESSION



- 11.1** If an athlete does not perform the announced figure, or if the figure does not have all the required elements or is performed other than according to the description, the Referee or Assistant Referee shall advise the judges and the athlete that the result of the figure will be a zero.
- 11.2** In Figure competition, if the award for the figure is a zero the Referee may review the official video together with two (2) World Aquatics Evaluators or World Aquatics Judges (ensuring that three different Federations are represented). They can have one (1) review in slow motion. If a definite decision cannot be reached after three (3) reviews, it shall be awarded in the athlete's favour. All judges will award a score prior to the review so that marks may be given to the athlete should the zero be overturned during the review process.
- 11.3** In a Figure competition for the 12 and Under-age category, if the athlete doesn't perform the correct figure, the athlete will be allowed to perform this figure again and a 1-point penalty will be applied. If the athlete fails again, then "O" will be applied.

## **12 CALCULATION OF THE FIGURE RESULT**

- 12.1** The highest and the lowest awards are cancelled (one of each). For 4 Judges the four scores would be averaged to obtain a 5<sup>th</sup> score. High and Low then dropped. Remaining 3 scores averaged for total. 5 Judges would be high and low dropped and then remaining three scores averaged. 6 Judges would be high and low dropped and remaining 4 scores averaged. The result is multiplied by the degree of difficulty to obtain the score for each of the four (4) or two (2) figures competed.
- 12.2** The sum of the four (4) or two (2) figures shall be divided by the total degree of difficulty of the figures competed and multiplied by 10, and then the penalties shall be deducted.
- 12.3** The figure result shall be:
- 12.3.1** For Solo the result shall be obtained according to Part Seven, Article 12.2.
- 12.3.2** For Duets – for each athlete the result shall be obtained according to VII.12.2. These results shall be added, and the total divided by two (2) to determine the average score (round off to the fourth decimal places) for the routine.
- 12.3.3** For Teams – for each athlete who competes in a Team routine the result shall be obtained according to Part Seven, Article 12.2. These results shall be added, and the total divided by the number of athletes in the Team to determine the average score (round off to the fourth decimal places) for the routine.
- 12.3.4** If an athlete after the preliminaries in Duet or Team is not able to compete in the Figures session (due to illness or injury), in Duet the figure score of the reserve is used to determine the total score for the Duet: in Team, the higher figure score of the two (2) reserves is used to determine the total score for the Team routine.

## **13 ROUTINE SESSIONS**

- 13.1** A Mixed Duet shall consist of one Woman and one Man.
- 13.2** An Open Team shall consist of at least four (4) but not more than eight (8) athletes (for the exceptions, see Part Seven, Article 6.2). The number of Team athletes may not change between Preliminary and Finals or Technical and Free Routines. The total number of athletes may include a maximum of 2 male athletes.
- 13.3** An Open Free Combination shall consist of at least four (4) but not more than ten (10) athletes. The total number of athletes may include a maximum of 2 male athletes.
- 13.4** An Open Acrobatic Routine shall consist of four (4) but no more than eight (8) athletes. The total number of competitors may include a maximum of 2 male athletes.
- 13.5** In an Open Free Combination and an Open Acrobatic Routines the number of athletes may not change between Preliminary and Finals.
- 13.6** In Women Duet, Mixed Duet, Open Team, Open Free Combination and Open Acrobatic Routine events, athletes who are listed on the entry according to Part Seven, Article 6.3.1 may be interchanged before routine sessions.





- 13.6.1** Any changes of the names of the athletes from the most recent entry lists must be handed to the Referee in writing at least two (2) hours prior to the published start time of routine number one. This time must be published in the official competition schedule. Changes after this can only be made in case of sudden illness or accident of an athlete and if the reserve is ready to compete without delaying the competition. The final decision in such a situation shall be made by the Referee.
- 13.6.2** If the lack of the reserve reduces the Open Team, Open Free Combination or Open Acrobatic Routine size to less than that defined in Part Seven, Article 4.4, 4.5, 6.2, 13.2, 13.3 or 13.4, the Team shall be disqualified.
- 13.6.3** Failure to notify the substitution and / or scratching according to Part Seven, Article 13.6.1 shall result in disqualification of the routine.
- 13.7** **Draw Procedure for Technical Routines, Free Routine Preliminaries, Open Free Combination Preliminaries or Open Acrobatic Routine Preliminaries (WCH and OG)**
- All routine events shall be entered according to the World Ranking (see Appendix 9). The draws will be divided into two parts: competitors with a current World Ranking and those without a World Ranking.
- Draw Process for Non-Ranked Athletes for preliminaries
- The non-ranked athletes will be randomly drawn into start order. These groups will compete first in the competition in the drawn order.
- Draw Process for World Ranked Athletes for preliminaries
- Athletes with World Rankings will compete in the draw following the non-ranked athletes, in reverse order of ranking with the highest ranked athlete competing last, followed by the next ranked athlete, etc. In cases of ties in the World Rankings, there will be a separate draw between tied athletes to decide the order of the main draw.
- Example: 30 entries in World Aquatics Championship Technical Duet – 18 ranked duets and 12 non-ranked duets. Draw Procedure: non-ranked duets will draw for start order 1-12 based on a random draw; ranked duets will compete in reverse order 13-30 based on world rank order.*
- .
- 13.7.1** The draw shall be manual if no World Aquatics sanctioned electronic draw system is available. The draw shall take place at least eighteen (18) hours before the first part of the competition and shall be public. Place and time shall be announced at least twenty-four (24) hours in advance.
- 13.7.2** The order of the draw shall be Teams, Free Combination, Acrobatic Routine, Duets, and Solos Preliminaries. For competitions involving both Technical and Free Routines, the draw for the event's Technical Routine shall be held first followed by the Free Routine Draw (Open Team Technical, Open Team Free Preliminary, Open Free Combination Preliminary, Open Acrobatic Routine Preliminary, Women Duet Technical, Women Duet Free Preliminary, Mixed Duet Technical, Mixed Duet Free Preliminary, Women Solo Technical, Women Solo Free Preliminary, Men Solo Technical and Men Solo Free Preliminary).
- 13.7.3** When a Federation draws start number one (1) in a Technical Routine or Free Routine Preliminary, Open Free Combination Preliminary or Open Acrobatic Routine Preliminary, or Direct Finals, this Federation shall be exempted from start number one (1) in all remaining preliminary or direct final sessions in the family the federation drew first in. (example Solo, Duet, Teams). This rule is not applicable when the start lists are established by using the World Ranking.
- 13.8** After the Figures and/or Technical Routines and Free Routines Preliminaries and Open Free Combination/Acrobatic Routine Preliminaries the first twelve (12) by total score shall compete in the Finals.
- If the number of participants in preliminaries is higher than 35, the first fourteen (14) by total score shall compete in the Finals.
- Exception: In World Aquatics (Senior) Championships: after each Technical / Free Routine / Open Acrobatic Routine, the twelve (12) best will compete in the respective Final.
- 13.8.1** The order of appearance in Finals will be: the top 12 finalists from the preliminaries will swim in reverse order. Example: number 12 swims first, number 11 swims 2nd, etc. In cases of ties in the Preliminaries, there will be a separate draw between tied competitors to decide the order of the main draw.,.



## 14 TIME LIMITS FOR ROUTINES

**14.1** Time limits for Technical Routines, Free Routines and Open Acrobatic Routines including ten (10) seconds for deck movement:

**14.1.1 Women Solo Technical Routine :** 2 minutes 00 seconds

**Men Solo Technical Routine :** 2 minutes 00 seconds

**Women Solo Free Routine** 2 minutes 15 seconds

**Men Solo Free Routine :** 2 minutes 15 seconds

**14.1.2 Women Duet Technical Routine:** 2 minutes 20 seconds

**Women Duet Free Routine:** 2 minutes 45 seconds

**14.1.3 Mixed Duet Technical Routine:** 2 minutes 20 seconds

**Mixed Duet Free Routine:** 2 minutes 45 seconds

**14.1.4 Open Team Technical Routine:** 2 minutes 50 seconds

**Open Team Free Routine:** 3 minutes 30 seconds

**Open Acrobatic Routine:** 3 minutes 00 seconds

**14.1.5 Open Free Combination** 3 minutes 00 seconds

**14.1.6** There shall be an allowance of five (5) seconds less or plus the allotted time for all routines.

**14.1.7** In all routine events, the walk-on of the athletes from the designated starting point to the achievement of a stationary position(s) may not exceed 30 seconds for Mixed Duet Technical and Free, Open Team Technical and Open Team Free, Open Free Combination and Open Acrobatic Routine, and may not exceed 20 seconds for any Solo and Duet Events.

**14.1.8** In routine events, when the routine starts in the water, the time allowance for the athletes to achieve a stationary starting position in the water shall not exceed 30 seconds for Mixed Duet Technical, Mixed Duet Free and Open Team Free, Open Team Technical and Open Free Combination and Open Acrobatic Routine and 20 seconds for any Solo and Duet Events.

**14.1.9** Age Group time limits - see Artistic Swimming Age Group Rule 25.5.

**14.2** Timing of the performance shall start with the walk-on and finish with the accompaniment. Timing of the walk-on shall commence when the first athlete moves past the designated starting point and ends when the last athlete assumes a starting position. Timing of the deck movements shall begin with the accompaniment and end as the last athlete leaves the deck.

**14.3** The accompaniment shall begin upon a signal from the Referee or appointed official. After the signal the athlete(s) must perform the routine without interruption (see Part Seven, Article 18). Routines may start on the deck or in the water, but they must finish in the water.

**14.4** The Timer shall check the overall time of the deck movements and the walk- on. If the time limit is exceeded for the deck movements, walk-on or there is a deviation from the routine time limit allowance (see VII.14.1) the Timer or Sound Center Manager shall advise the Referee, or the appointed official designated by the Referee.

**14.5** All Athletes shall provide music in accordance with the quality requirements of each Organising Committee as stated in the bulletin. Organisers may request new music should it not meet the standards required. Team Leaders will provide on the registration form the exact running time of the music, not swimming time. The official time will be reviewed by the Sound Center Manager's electronic running time. The Sound Center Manager will notify the Referee of any music that does not comply with Artistic Swimming timing rules.

**14.6** If there is no official training with music, the organizer must provide the athlete or Team Leader the opportunity to hear their music in the competition venue prior to the start of the event.

## 15 MUSIC ACCOMPANIMENTS



- 15.1** The Sound Center Manager shall be responsible for the securing and properly presenting the accompaniment for each routine.
- 15.2** For World Aquatics competitions, a decibel (sound level) meter shall be used to monitor the sound level and ensure that no person is exposed to average sound levels exceeding 90 decibels (rms) or momentary peak sound levels exceeding 100 decibels.
- 15.3** Team Leaders are responsible for submitting their music electronically via the Internet to the Sound Center Manager according to the instructions in the bulletin at least 14 days prior to the start of practice sessions. Each submission shall be labelled as to event, name of the athletes and national Federation.
- The Organising Committee must supply a World Aquatics approved music system in the competition pool and have a second sound system in the practice pool.
- 15.4** Clearance of Rights for Competition Music: All music used by the competing Federations must be cleared of rights prior to the start of each competition. World Aquatics will not be held accountable for any lawsuits resulting from copyright infringement. All expenses resulting from such procedures will be the responsibility of each competitor and their respective Federation.
- Every Federation participating in Artistic Swimming competition must upload their music and corresponding licenses to the ClicknClear platform before every competition. You may obtain the necessary licenses for your music by any means of your choice. You may also request them through the ClicknClear platform should you wish to.
- This procedure is now mandatory and from 2026 onwards, failing to provide the correct licenses may prevent you from taking part in Artistic Swimming competitions.

## **16 ROUTINE PANELS**

- 16.1** Two (2) panels of five (5) judges must officiate in all routines: one for Elements and one for Artistic Impression.
- Two (2) groups of three (3) Technical Controllers must officiate in all routines: one group to check the number, order of performance and predeclared difficulty of the Free Elements (Hybrids and Acrobatics), and the performance and predeclared order of Technical Required Elements (technical routines), and one group to register the number and type of synchronisation errors observed. The Technical Controllers may use the VAR (Video Assisted Review). They can have one (1) review in slow motion for each element or transition part they are questioning. In order for a Base Mark or Major Errors to be applied or the review to be dismissed, two of the three TC must be in agreement.
- 16.1.1** There will be one (1) Difficulty Technical Controller (DTC) and two (2) Difficulty Assistant Technical Controllers (DATC). The purpose of the role is to verify all of the Technical Required Elements (technical routines), and the Free Elements (Hybrids and Acrobatics) performed in real time as they occur in a routine. The Referee is consulted in case of a Conflict of Interest where one of the DTC recuses themselves. They are also responsible for the identification of any "technical errors", which are differences in what is declared on the Coach Card to what is performed in the water OR an error in a Technical Required Element (technical routines). The Difficulty Technical Controller will have communication to the Referee.
- 16.1.2** There will be three (3) Synchronisation Technical Controllers (STC) who will record the number of synchronisation errors (unequal actions) they observe during the performance of a routine. They will be seated on deck with a clear view of the pool.
- 16.2** During routine sessions the officials shall be placed in elevated positions on opposite sides of the pool.
- 16.3** At the completion of each routine the Judges submit their scores.
- 16.4** If one or more Judges by reason of illness or other unforeseen circumstances has made no award for a routine, the average of the awards of the other judges shall be computed and shall be considered as the award. This shall be calculated to the nearest 0.25 point.
- 16.4.1** If an unexpected situation happens during a session and one or more Judges cannot give an award for a routine, the Referee can disrupt the session and performance. After the settlement of a matter and safe confirmation, the Referee shall resume the session and allow the athlete to swim again.



**16.5** The Referee approves the display of the unofficial scores on the scoreboard. Judges' scores cannot be changed after being posted on the scoreboard. Scores are only official once the Referee has signed them at the end of every session.

**16.6** For all Routines, official(s) will be appointed by the Referee & World Aquatics Delegate/Commission to monitor the use of the bottom of the pool.

## **17 JUDGEMENT OF ROUTINES**

**17.1** In Routines, the athlete can obtain points from 0 – 10 using 0.25 points

<b>Perfect</b>	10
<b>Near perfect</b>	9.75 - 9.5
<b>Excellent</b>	9.25 - 9.0
<b>Very Good</b>	8.75 - 8.0
<b>Good</b>	7.75 - 7.0
<b>Competent</b>	6.75 - 6.0
<b>Satisfactory</b>	5.75 - 5.0
<b>Deficient</b>	4.75 - 4.0
<b>Weak</b>	3.75 - 3.0
<b>Very weak</b>	2.75 - 2.0
<b>Hardly recognizable</b>	1.75 - 0.25
<b>Completely failed</b>	0

**17.2** In all Routines each Judge shall award scores from 0-10 points each (see Part Seven, Article 17.1).

Elements panel judges shall award one (1) score for the execution of each Element (Free and Technical Required).

Artistic Impression panel judges shall award three (3) scores, one (1) score for choreography and musicality, one (1) score for performance and one (1) score for transitions.

Difficulty Technical Controllers check the predeclared difficulty on the submitted Coach Card. Difficulty values can be found in Appendixes 6 and 7 and Coach Card format in Appendix 6 of Part Seven. World Aquatics reserves the right to adjust the components assigned to each category as required.

### **17.2.1 First panel – ELEMENTS**

In **EXECUTION** consider: the level of excellence in performing highly specialized skills. Execution of all routine Elements: Technical Required Elements and Elements (Hybrids and Acrobatics).

### **17.2.2 Second panel – ARTISTIC IMPRESSION**

In **CHOREOGRAPHY** and **MUSICALITY** consider the creative skill of composing a routine that combines artistic and technical elements. The design and weaving together of variety, creativity, and innovation of all movements including elements and transitions. The pool coverage. Expressing the mood of the music, use of the music's structure and the movements and synchronisation with the music.

In **PERFORMANCE** consider the manner in which the athlete(s) present(s) the routine to the viewers including the walk-on and deck movements. The use of body language to express physical and emotional power, confidence, and total command of the performance.

In **TRANSITIONS** consider the execution and complexity of varied and purposeful movements, propulsions and strokes that link routine elements.

## **18 DEDUCTION, PENALTIES AND OTHER MATTERS IN ROUTINES**

### **18.1 Solo Technical Routine**



- 18.1.1** Deck Walk-on: An eight (8) point penalty shall be deducted from the routine score if the time limit of 20 seconds for the deck walk-on is exceeded.
- 18.1.2** **Deck Movements: An eight (8)** point penalty shall be deducted from the routine score if the time limit of ten (10) seconds for deck movements is exceeded.
- 18.1.3** **New Start: A two (2)** point penalty shall be deducted from the routine score if a routine is interrupted by an athlete during the deck movements and a new start is allowed.
- 18.1.4** Overall Routine Time: An eight (8) point penalty shall be deducted from the routine score if there is a deviation from the specified routine time limit allowed (less or more than) for the routine and in accordance with Part Seven - 14.1 and 25.5 - Age Group Time Limit Rules.
- 18.1.5** Stop Swimming/Use of Pool Wall: If an athlete stops swimming or makes clear support use of the pool wall before the routine is completed, the routine will be disqualified. The Referee shall assess if the cessation is caused by circumstances beyond the control of the athlete. The Referee may allow the routine to be re-swum during the session.
- 18.1.6** Deliberate Use of Bottom to Propel: An eight (8) penalty shall be deducted from the routine score if an athlete has made deliberate use of the bottom of the pool during a routine to propel themselves.
- 18.1.7** Base Mark: All Free Elements (Hybrids and Acrobatics) have a calculated Base Mark that is the minimum Degree of Difficulty that will be applied if one (1) or more components of the element is not performed or is not in conformance to what is declared in the Coach Card.
- 18.1.8** Exceeding Number of Predetermined Elements: A two (2) point penalty shall be deducted from the Elements score for each element exceeding the predetermined number assigned to the particular event and category.
- 18.1.9** Omit All, Part or Incorrect Action of Technical Required Element: If an athlete omits all or part of a Technical Required Element or performs an incorrect action in a Technical Required Element, the Difficulty Technical Controllers shall make note that the declared movement was not correct. If the DTC video review confirms a violation, a zero (0) will be assigned as the Degree of Difficulty for this particular Technical Required Element.
- 18.1.10** Swum Out of Order: The Difficulty Technical Controller (DTC) shall inform the Referee to submit a zero (0) for each Technical Required Element #1 - #5 swum out of the order declared on the Coach Card (each violation of General Requirement #4 in Part Seven, Appendix 2).
- 18.1.11** Additional Routine Requirement # 6: An eight (8) point penalty shall be deducted from the Elements Score for violation of Solo Additional Routine Requirement #6 in Appendix 2:  
  
One (1) additional hybrid must be performed.  
  
Exceeding Free Hybrid maximums: if 5x per family or 3x per technique is exceeded in a Free Hybrid the DTC shall apply a Base Mark to the Free Hybrid.
- 18.2** **Duet Technical Routine**
- 18.2.1** Deck Walk-on: An eight (8) point penalty shall be deducted from the routine score if the time limit of 20 seconds for the deck walk-on is exceeded.
- 18.2.2** Deck Movements: An eight (8) point penalty shall be deducted from the routine score if the time limit of ten (10) seconds for deck movements is exceeded.
- 18.2.3** **New Start: A two (2)** point penalty shall be deducted from the routine score if a routine is interrupted by an athlete during the deck movements and a new start is allowed.
- 18.2.4** **Overall Routine Time: An eight (8)** point penalty shall be deducted from the routine score if there is a deviation from the specified routine time limit allowed (less or more than) for the routine and in accordance with Part Seven - 14.1 and 25.5 - Age Group Time Limit Rules.
- 18.2.5** Stop Swimming/Use of Pool Wall: If one (1) or more athlete(s) stop swimming or makes clear support use of the pool wall before the routine is completed, the routine will be disqualified. The Referee shall assess if the cessation is caused by circumstances beyond the control of the athlete(s). The Referee may allow the routine to be re-swum during the session.



- 18.2.6** Deliberate Use of Bottom to Propel: An eight (8) penalty shall be deducted from the routine score if an athlete has made deliberate use of the bottom of the pool during a routine to propel themselves.
- 18.2.7** Deliberate Use of Bottom to Assist: An eight (8) point penalty shall be deducted from the routine score if an athlete has made deliberate use of the bottom of the pool to assist another athlete. No penalty will be applied when the contact with the bottom of the pool results from the swimmer's self-protection from injuries by impact.
- 18.2.8** Base Mark: All Free Elements (Hybrids and Acrobatics) have a calculated Base Mark that is the minimum Degree of Difficulty that will be applied if one (1) or more components of the element is not performed or is not in conformance to what is declared in the Coach Card.
- 18.2.9** Exceeding Number of Pretermimed Elements: A two (2) point penalty shall be deducted from the Elements score for each element exceeding the predetermined number assigned to the particular event and category.
- 18.2.10** Omit All, Part or Incorrect Action of Technical Required Element: If one (1) or more athlete(s) omit all or part of a Technical Required Element or performs an incorrect action in a Technical Required Element, the Difficulty Technical Controllers shall make note that the declared movement was not correct. If the DTC video review confirms a violation, a zero (0) will be assigned as the Degree of Difficulty for this particular Technical Required Element.
- 18.2.11** Swum Out of Order: The Difficulty Technical Controller (DTC) shall inform the Referee to submit a zero (0) for each Technical Required Element #1 - #5 swum out of the order declared on the Coach Card (each violation of General Requirement #4 in Part Seven, Appendix 2).
- 18.2.12** General Requirement # 6: A two (2) point penalty shall be deducted from the Elements Score for each violation of General Requirement #6 in Appendix 2:  
  
With the exception of Deck Work and Entry into the water, getting into and out of the Circle (Team), and Acrobatics, Technical Required Elements, Free Hybrids and Transitions are to be performed simultaneously and facing the same direction by all duet or team members.
- 18.2.13** Additional Routine Requirements #6 and #7: An eight (8) point penalty shall be deducted from the Elements Score for violation of Women's Duet Additional Routine Requirement #6 and #7 in Appendix 2:  
  
6 - One (1) additional hybrid must be performed.  
7 - One (1) Pair Acrobatic must be performed.
- 18.2.14** Synchronisation errors and penalty values  
  
For all routines, the sum of all synchronisation errors (unequal actions) observed by the Synchronisation Technical Controllers (STC), (each factored by its assigned value) will be deducted from the Elements Score. Types of Synchronisation errors and penalty values are:
- |         |            |
|---------|------------|
| Small   | 0.1 points |
| Obvious | 0.5 points |
| Major   | 3.0 points |
- The description of small, obvious, and major synchronisation errors (unequal actions) is detailed in the Scoring Synchronisation Guide. Maximum deduction can reduce the Elements score to zero (0), but not to a negative Elements score.
- 18.2.15** **Exceeding Free Hybrid Maximums:** If 5x per family or 3x per technique is exceeded in a Free Hybrid, the DTC shall apply a Base Mark to the Free Hybrid.
- 18.2.16** If a reserved acro code is used by a federation that does not own that code, a Base Mark will be applied to the Acrobatic.
- 18.3** **Mixed Duet Technical Routine**
- 18.3.1** Deck Walk-on: An eight (8) point penalty shall be deducted from the routine score if the time limit of 30 seconds for the deck walk-on is exceeded.
- 18.3.2** Deck Movements: An eight (8) point penalty shall be deducted from the routine score if the time limit of ten (10) seconds for deck movements is exceeded.



- 18.3.3 New Start:** A two (2) point penalty shall be deducted from the routine score if a routine is interrupted by an athlete during the deck movements and a new start is allowed.
- 18.3.4 Overall Routine Time:** An eight (8) point penalty shall be deducted from the routine score if there is a deviation from the specified routine time limit allowed (less or more than) for the routine and in accordance with Part Seven - 14.1 and 25.5 - Age Group Time Limit Rules.
- 18.3.5 Stop Swimming/Use of Pool Wall:** If one (1) or more athlete(s) stops swimming or makes clear support use of the pool wall before the routine is completed, the routine will be disqualified. The Referee shall assess if the cessation is caused by circumstances beyond the control of the athlete(s). The Referee may allow the routine to be re-swum during the session.
- 18.3.6 Deliberate Use of Bottom to Propel:** An eight (8) penalty shall be deducted from the routine score if an athlete has made deliberate use of the bottom of the pool during a routine to propel themselves.
- 18.3.7 Deliberate Use of Bottom to Assist:** An eight (8) point penalty shall be deducted from the routine score if an athlete has made deliberate use of the bottom of the pool to assist another athlete. No penalty will be applied when the contact with the bottom of the pool results from the swimmer's self-protection from injuries by impact.
- 18.3.8 Base Mark:** All Free Elements (Hybrids and Acrobatics) have a calculated Base Mark that is the minimum Degree of Difficulty that will be applied if one (1) or more components of the element is not performed or is not in conformance to what is declared in the Coach Card.
- 18.3.9 Exceeding Number of Predetermined Elements:** A two (2) point penalty shall be deducted from the Elements score for each element exceeding the predetermined number assigned to the particular event and category.
- 18.3.10 Omit All, Part or Incorrect Action of Technical Required Element:** If one (1) or more athlete(s) omit all or part of a Technical Required Element or performs an incorrect action in a Technical Required Element, the Difficulty Technical Controllers shall make note that the declared movement was not correct. If the DTC video review confirms a violation, a zero (0) will be assigned as the Degree of Difficulty for this particular Technical Required Element.
- 18.3.11 Swum Out of Order:** The Difficulty Technical Controller (DTC) shall inform the Referee to submit a zero (0) for each Technical Required Element #1 - #3 swum out of the order declared on the Coach Card (each violation of General Requirement #4 in Part Seven, Appendix 2).
- 18.3.12 General Requirement # 7:** A two (2) point penalty shall be deducted from the Elements Score for each violation of General Requirement #7 in Appendix 2:
- Only Technical Required Elements must be performed simultaneously and facing the same direction. Deckwork and Entry into the water, Free Hybrid, Required Hybrid, Entry into or Exit out of Technical Required Elements, Transitions and Pair Acrobatics DO NOT have this restriction and MAY be performed freely (non-simultaneous and facing different directions)..
- 18.3.13 Additional Routine Requirements # 4, 5, 6 and 7:** An eight (8) point penalty shall be deducted from the Elements Score for each violation of Mixed Duet Additional Routine Requirements #4, 5, 6 and 7 in Appendix 2:
- 4 – One (1) free hybrid
- 5 – One (1) required hybrid which must contain only one Thrust declaration and two (2) different Connection declarations
- 6 – Two (2) Pair Acrobatics of free choice but must not repeat the same acrobatic
- 7 – **Three (3)** declared Sustained Surface Connections (“SuCon”) with travel (1m or more) or rotation (180° or more)
- 18.3.14 Repetition of Pair Acrobatic:** **A Base Mark shall be applied** for a repetition of the Pair Acrobatic.
- For **Mixed** Duet – the same pair acrobatic code may not be used.
- 18.3.15 Synchronisation errors and penalty values**
- For all routines, the sum of all synchronisation errors (unequal actions) observed by the Synchronisation Technical Controllers (STC), (each factored by its assigned value) will be deducted from the Elements Score. Types of Synchronisation errors and penalty values are:



Small	0.1 points
Obvious	0.5 points
Major	3.0 points

The description of small, obvious, and major synchronisation errors (unequal actions) is detailed in the Scoring Synchronisation Guide. Maximum deduction can reduce the Elements score to zero (**O**), but not to a negative Elements score.

- 18.3.16** Exceeding Free Hybrid maximums: If 5x per family or 3x per technique is exceeded in a Free Hybrid, the DTC shall apply a Base Mark to the Free Hybrid.
- 18.3.17** If a reserved acro code is used by a federation that does not own that code, a Base Mark will be applied to the Acrobatic.
- 18.4 Team Technical Routine**
- 18.4.1** Less than Eight: A half (0.5) point penalty shall be deducted from the total score for each athlete less than eight (8) (see Part Seven, Article 13.2).
- 18.4.2** Deck Walk-on: An eight (8) point penalty shall be deducted from the routine score if the time limit of 30 seconds for the deck walk-on is exceeded.
- 18.4.3** Deck Movements: An eight (8) point penalty shall be deducted from the routine score if the time limit of ten (10) seconds for deck movements is exceeded.
- 18.4.4** New Start: A **two (2)** point penalty shall be deducted from the routine score if a routine is interrupted by an athlete during the deck movements and a new start is allowed.
- 18.4.5 Overall Routine Time:** An **eight (8)** point penalty shall be deducted from the routine score if there is a deviation from the specified routine time limit allowed (less or more than) for the routine and in accordance with Part Seven - 14.1 and 25.5 - Age Group Time Limit Rules.
- 18.4.6** Stop Swimming/Use of Pool Wall: If one (1) or more athlete(s) stops swimming or makes clear support use of the pool wall before the routine is completed, the routine will be disqualified. The Referee shall assess if the cessation is caused by circumstances beyond the control of the athlete. The Referee may allow the routine to be re-swum during the session.
- 18.4.7** Deliberate Use of Bottom to Propel: An eight (8) penalty shall be deducted from the routine score if an athlete has made deliberate use of the bottom of the pool during a routine to propel themselves.
- 18.4.8** Deliberate Use of Bottom to Assist: An eight (8) point penalty shall be deducted from the routine score if an athlete has made deliberate use of the bottom of the pool to assist another athlete. No penalty will be applied when the contact with the bottom of the pool results from the swimmer's self-protection from injuries by impact.
- 18.4.9** Base Mark: All Free Elements (Hybrids and Acrobatics) have a calculated Base Mark that is the minimum Degree of Difficulty that will be applied if one (1) or more components of the element is not performed or is not in conformance to what is declared in the Coach Card.
- 18.4.10** Exceeding Number of Predetermined Elements: A two (2) point penalty shall be deducted from the Elements score for each element exceeding the predetermined number assigned to the particular event and category.
- 18.4.11** Omit All, Part or Incorrect Action of Technical Required Element: If one (1) or more athlete(s) omit all or part of a Technical Required Element or performs an incorrect action in a Technical Required Element, the Difficulty Technical Controllers shall make note that the declared movement was not correct. If the DTC video review confirms a violation, a zero (O) will be assigned as the Degree of Difficulty for this particular Technical Required Element.
- 18.4.12** Swum Out of Order: The Difficulty Technical Controller (DTC) shall inform the Referee to submit a zero (O) for each Technical Required Element #1 - #5 swum out of the order declared on the Coach Card (each violation of General Requirement #4 in Part Seven, Appendix 2).
- 18.4.13** General Requirement # 6: A two (2) point penalty shall be deducted from the Elements Score for each violation of General Requirement #6 in Appendix 2:





With the exception of Deck Work and Entry into the water, getting into and out of the Circle (Team), and Acrobatics, Technical Required Elements, Free Hybrids and Transitions are to be performed simultaneously and facing the same direction by all duet or team members.

**18.4.14** Additional Routine Requirements #6 and #7: An eight (8) point penalty shall be deducted from the Elements Score for each violation of Team Additional Routine Requirements #6 and 7 in Appendix 2:

6 - Two (2) additional hybrids, one of which must include a Cadence action

7 - One (1) acrobatic movement must be performed by all team members.

**18.4.15** Routine Requirement # 7 DD: A Base Mark shall be applied for a violation of Team DD Routine Requirement #7 for the acrobatic movement exceeding 3.00 (inclusive of BM value of 0.5).

**18.4.16** Maximum of One Circle Pattern: A two (2) point penalty shall be deducted from the Elements Score if a Team Technical routine exceeds a maximum of one (1) circle pattern.

**18.4.17** Synchronisation errors and penalty values

For all routines, the sum of all synchronisation errors (unequal actions) observed by the Synchronisation Technical Controllers (STC), (each factored by its assigned value) will be deducted from the Elements Score. Types of Synchronisation errors and penalty values are:

Small	0.1 points
Obvious	0.5 points
Major	3.0 points

The description of small, obvious, and major synchronisation errors (unequal actions) is detailed in the Scoring Synchronisation Guide. Maximum deduction can reduce the Elements score to zero (**0**), but not to a negative Elements score.

**18.4.18** Exceeding Free Hybrid maximums: If 5x per family or 3x per technique is exceeded in a Free Hybrid, the DTC shall apply a Base Mark to the Free Hybrid.

**18.4.19** If a reserved acro code is used by a federation that does not own that code, a Base Mark will be applied to the Acrobatic.

## **18.5 Solo Free Routine**

**18.5.1** Deck Walk-on: An eight (8) point penalty shall be deducted from the routine score if the time limit of 20 seconds for the deck walk-on is exceeded.

**18.5.2** Deck Movements: An eight (8) point penalty shall be deducted from the routine score if the time limit of ten (10) seconds for deck movements is exceeded.

**18.5.3** **New Start:** A two (2) point penalty shall be deducted from the routine score if a routine is interrupted by an athlete during the deck movements and a new start is allowed.

**18.5.4** **Overall Routine Time:** An eight (8) point penalty shall be deducted from the routine score if there is a deviation from the specified routine time limit allowed (less or more than) for the routine and in accordance with Part Seven - 14.1 and 25.5 - Age Group Time Limit Rules.

**18.5.5** Stop Swimming/Use of Pool Wall: If an athlete stops swimming or makes clear support use of the pool wall before the routine is completed, the routine will be disqualified. The Referee shall assess if the cessation is caused by circumstances beyond the control of the athlete. The Referee may allow the routine to be re-swum during the session.

**18.5.6** Deliberate Use of Bottom to Propel: An eight (8) penalty shall be deducted from the routine score if an athlete has made deliberate use of the bottom of the pool during a routine to propel themselves.

**18.5.7** Base Mark: All Free Elements (Hybrids and Acrobatics) have a calculated Base Mark that is the minimum Degree of Difficulty that will be applied if one (1) or more components of the element is not performed or is not in conformance to what is declared in the Coach Card.



- 18.5.8** Exceeding Number of Predetermined Elements: A two (2) point penalty shall be deducted from the Elements score for each element exceeding the predetermined number assigned to the particular event and category.
- 18.5.9** Not Including a Skill from every Family: An eight (8) point penalty shall be deducted from the Elements score for NOT including a skill from every family in the routine (with the exception of connections in Solo).
- 18.5.10** Exceeding Free Hybrid maximums: If 5x per family or 3x per technique is exceeded in a Free Hybrid, the DTC shall apply a Base Mark to the Free Hybrid.

**18.6 Duet Free Routine**

- 18.6.1** Deck Walk-on: An eight (8) point penalty shall be deducted from the routine score if the time limit of 20 seconds for the deck walk-on is exceeded.
- 18.6.2** Deck Movements: An eight (8) point penalty shall be deducted from the routine score if the time limit of ten (10) seconds for deck movements is exceeded.
- 18.6.3** **New Start:** A two (2) point penalty shall be deducted from the routine score if a routine is interrupted by an athlete during the deck movements and a new start is allowed.
- 18.6.4** **Overall Routine Time:** An eight (8) point penalty shall be deducted from the routine score if there is a deviation from the specified routine time limit allowed (less or more than) for the routine and in accordance with Part Seven - 14.1 and 25.5 - Age Group Time Limit Rules.
- 18.6.5** Stop Swimming/Use of Pool Wall: If one (1) or more athlete(s) stop swimming or makes clear support use of the pool wall before the routine is completed, the routine will be disqualified. The Referee shall assess if the cessation is caused by circumstances beyond the control of the athlete. The Referee may allow the routine to be re-swum during the session.
- 18.6.6** Deliberate Use of Bottom to Propel: An eight (8) penalty shall be deducted from the routine score if an athlete has made deliberate use of the bottom of the pool during a routine to propel themselves.
- 18.6.7** Deliberate Use of Bottom to Assist: An eight (8) point penalty shall be deducted from the routine score if an athlete has made deliberate use of the bottom of the pool to assist another athlete. No penalty will be applied when the contact with the bottom of the pool results from the swimmer's self-protection from injuries by impact.
- 18.6.8** Base Mark: All Free Elements (Hybrids and Acrobatics) have a calculated Base Mark that is the minimum Degree of Difficulty that will be applied if one (1) or more components of the element is not performed or is not in conformance to what is declared in the Coach Card.
- 18.6.9** Exceeding Number of Pretermind Elements: A two (2) point penalty shall be deducted from the Elements score for each element exceeding the predetermined number assigned to the particular event and category.
- 18.6.10** Not Including a Skill from every Family: An eight (8) point penalty shall be deducted from the Elements score for NOT including a skill from every family in the routine (with the exception of connections in Solo). All routine members must perform that skill in the same declaration on the coach card (not factored).
- 18.6.11** Repetition of Pair Acrobatic: A Base Mark shall be applied for any repetition of Pair Acrobatics.  
For Duet – the same pair acrobatic code may not be used.
- 18.6.12** Synchronisation errors and penalty values  
For all routines, the sum of all synchronisation errors (unequal actions) observed by the Synchronisation Technical Controllers (STC), (each factored by its assigned value) will be deducted from the Elements Score. Types of Synchronisation errors and penalty values are:

Small	0.1 points
Obvious	0.5 points
Major	3.0 points

The description of small, obvious, and major synchronisation errors (unequal actions) is detailed in the Scoring Synchronisation Guide. Maximum deduction can reduce the Elements score to zero (0), but not to a negative Elements score.



- 18.6.13** Exceeding Free Hybrid maximums: If 5x per family or 3x per technique is exceeded in a Free Hybrid, the DTC shall apply a Base Mark to the Free Hybrid.
- 18.6.14** If a reserved acro code is used by a federation that does not own that code, a Base Mark will be applied to the Acrobatic.
- 18.7** **Mixed Duet Free Routine**
- 18.7.1** Deck Walk-on: An eight (8) point penalty shall be deducted from the routine score if the time limit of 30 seconds for the deck walk-on is exceeded.
- 18.7.2** Deck Movements: An eight (8) point penalty shall be deducted from the routine score if the time limit of ten (10) seconds for deck movements is exceeded.
- 18.7.3** **New Start:** A two (2) point penalty shall be deducted from the routine score if a routine is interrupted by an athlete during the deck movements and a new start is allowed.
- 18.7.4** **Overall Routine Time:** An eight (8) point penalty shall be deducted from the routine score if there is a deviation from the specified routine time limit allowed (less or more than) for the routine and in accordance with Part Seven - 14.1 and 25.5 - Age Group Time Limit Rules.
- 18.7.5** Stop Swimming/Use of Pool Wall: If one (1) or more athlete(s) stops swimming or makes clear support use of the pool wall before the routine is completed, the routine will be disqualified. The Referee shall assess if the cessation is caused by circumstances beyond the control of the athlete. The Referee may allow the routine to be re-swum during the session.
- 18.7.6** Deliberate Use of Bottom to Propel: An eight (8) penalty shall be deducted from the routine score if an athlete has made deliberate use of the bottom of the pool during a routine to propel themselves.
- 18.7.7** Deliberate Use of Bottom to Assist: An eight (8) point penalty shall be deducted from the routine score if an athlete has made deliberate use of the bottom of the pool to assist another athlete. No penalty will be applied when the contact with the bottom of the pool results from the swimmer's self-protection from injuries by impact.
- 18.7.8** Base Mark: All Free Elements (Hybrids and Acrobatics) have a calculated Base Mark that is the minimum Degree of Difficulty that will be applied if one (1) or more components of the element is not performed or is not in conformance to what is declared in the Coach Card.
- 18.7.9** Exceeding Number of Predetermined Elements: A two (2) point penalty shall be deducted from the Elements score for each element exceeding the predetermined number assigned to the particular event and category.
- 18.7.10** Not Including a Skill from every Family: An eight (8) point penalty shall be deducted from the Elements score for NOT including a skill from every family in the routine (with the exception of connections in Solo). All routine members must perform that skill in the same declaration on the coach card (not factored).
- 18.7.11** Additional Required Movements Not Performed: A two (2) point penalty shall be deducted from the Artistic Impression score for each of the additional required movements in Appendix 3 not performed.
- A minimum of 3 (Youth/12U) or 4 (Senior/Junior) declared Surface Connections ( SuCon) with travel (1m or more) or rotation (180° or more).
- 18.7.12** Repetition of Pair Acrobatic: A Base Mark shall be applied for any repetition of Pair Acrobatics.
- For Mixed Duet – the same pair acrobatic code may not be used.
- 18.7.13** Synchronisation errors and penalty values
- For all routines, the sum of all synchronisation errors (unequal actions) observed by the Synchronisation Technical Controllers (STC), (each factored by its assigned value) will be deducted from the Elements Score. Types of Synchronisation errors and penalty values are:

Small	0.1 points
Obvious	0.5 points
Major	3.0 points

The description of small, obvious, and major synchronisation errors (unequal actions) is detailed in the Scoring Synchronisation Guide. Maximum deduction can reduce the Elements score to zero (0), but not to a negative Elements score.



- 18.7.14** Exceeding Free Hybrid maximums: If 5x per family or 3x per technique is exceeded in a Free Hybrid, the DTC shall apply a Base Mark to the Free Hybrid.
- 18.7.15** If a reserved acro code is used by a federation that does not own that code, a Base Mark will be applied to the Acrobatic.
- 18.8 Team Free Routine**
- 18.8.1** Less than Eight: A half (0.5) point penalty shall be deducted from the total score for each athlete less than eight (8) (see Part Seven, Article 13.2).
- 18.8.2** Deck Walk-on: An eight (8) point penalty shall be deducted from the routine score if the time limit of 30 seconds for the deck walk-on is exceeded.
- 18.8.3** Deck Movements: An eight (8) point penalty shall be deducted from the routine score if the time limit of ten (10) seconds for deck movements is exceeded.
- 18.8.4** **New Start:** A **two (2)** point penalty shall be deducted from the routine score if a routine is interrupted by an athlete during the deck movements and a new start is allowed.
- 18.8.5** **Overall Routine Time:** An **eight (8)** point penalty shall be deducted from the routine score if there is a deviation from the specified routine time limit allowed (less or more than) for the routine and in accordance with Part Seven - 14.1 and 25.5 - Age Group Time Limit Rules.
- 18.8.6** Stop Swimming/Use of Pool Wall: If one (1) or more athlete(s) stops swimming or makes clear support use of the pool wall before the routine is completed, the routine will be disqualified. The Referee shall assess if the cessation is caused by circumstances beyond the control of the athlete. The Referee may allow the routine to be re-swum during the session.
- 18.8.7** Deliberate Use of Bottom to Propel: An eight (8) penalty shall be deducted from the routine score if an athlete has made deliberate use of the bottom of the pool during a routine to propel themselves.
- 18.8.8** Deliberate Use of Bottom to Assist: An eight (8) point penalty shall be deducted from the routine score if an athlete has made deliberate use of the bottom of the pool to assist another athlete. No penalty will be applied when the contact with the bottom of the pool results from the swimmer's self-protection from injuries by impact.
- 18.8.9** Base Mark: All Free Elements (Hybrids and Acrobatics) have a calculated Base Mark that is the minimum Degree of Difficulty that will be applied if one (1) or more components of the element is not performed or is not in conformance to what is declared in the Coach Card.
- 18.8.10** Exceeding Number of Predetermined Elements: A two (2) point penalty shall be deducted from the Elements score for each element exceeding the predetermined number assigned to the particular event and category.
- 18.8.11** Not Including a Skill from every Family: An eight (8) point penalty shall be deducted from the Elements score for NOT including a skill from every family in the routine (with the exception of connections in Solo). All routine members must perform that skill in the same declaration on the coach card (not factored).
- 18.8.12** Exceeding the DD Safety Limit - Youth Team: A Base Mark shall be applied for each acrobatic movement exceeding the DD safety limit: Group A (2.7), Group B (2.8), Group C (2.8) and Group P (3.0). All DD limits are inclusive of Base Mark value of 0.5.
- 18.8.13** Exceeding the DD Safety Limit - 12U Team: A Base Mark shall be applied for each acrobatic movement exceeding the DD safety limit: Group A (2.5), Group B (2.6), Group C (2.6) and Group P (2.8). All DD limits are inclusive of Base Mark value of 0.5.
- 18.8.14** Repetition of Team Acrobatic: a Base Mark shall be applied for any repetition of acrobatics.
- For Team - Must not repeat the same acrobatic is defined as:
- For Group A – can't repeat the same position/s (as P1 or as P2), with the exception of the third position bonus
- For Group B – can't repeat the same construction, can't repeat the same type of connection (grip)
- For Group C – can't repeat the same construction
- For Group P – can't repeat the same construction, can't repeat the same type of connection (grip), AND can't repeat the same position/s (as P1 or as P2), with the exception of the third position bonus

**18.8.15** Synchronisation errors and penalty values

For all routines, the sum of all synchronisation errors (unequal actions) observed by the Synchronisation Technical Controllers (STC), (each factored by its assigned value) will be deducted from the Elements Score. Types of Synchronisation errors and penalty values are:

Small	0.1 points
Obvious	0.5 points
Major	3.0 points

The description of small, obvious, and major synchronisation errors (unequal actions) is detailed in the Scoring Synchronisation Guide. Maximum deduction can reduce the Elements score to zero, but not to a negative Elements score.

**18.8.16** Exceeding Free Hybrid maximums: If 5x per family or 3x per technique is exceeded in a Free Hybrid, the DTC shall apply a Base Mark to the Free Hybrid.

**18.8.17** If a reserved acro code is used by a federation that does not own that code, a Base Mark will be applied to the Acrobatic.

**18.9** Acrobatic Routine

**18.9.1** Less than Eight: A half (0.5) point penalty shall be deducted from the total score for each athlete less than eight (8) (see Part Seven, Article 13.4).

**18.9.2** Deck Walk-on: An eight (8) point penalty shall be deducted from the routine score if the time limit of 30 seconds for the deck walk-on is exceeded.

**18.9.3** Deck Movements: An eight (8) point penalty shall be deducted from the routine score if the time limit of ten (10) seconds for deck movements is exceeded.

**18.9.4** **New Start:** A **two (2)** point penalty shall be deducted from the routine score if a routine is interrupted by an athlete during the deck movements and a new start is allowed.

**18.9.5** **Overall Routine Time:** An **eight (8)** point penalty shall be deducted from the routine score if there is a deviation from the specified routine time limit allowed (less or more than) for the routine and in accordance with Part Seven, Article 25.5 - Age Group Time Limit Rules.

**18.9.6** Stop Swimming/Use of Pool Wall: If one (1) or more athlete(s) stops swimming or makes clear support use of the pool wall before the routine is completed, the routine will be disqualified. The Referee shall assess if the cessation is caused by circumstances beyond the control of the athlete. The Referee may allow the routine to be re-swum during the session.

**18.9.7** Deliberate Use of Bottom to Propel: An eight (8) penalty shall be deducted from the routine score if an athlete has made deliberate use of the bottom of the pool during a routine to propel themselves.

**18.9.8** Deliberate Use of Bottom to Assist: An eight (8) point penalty shall be deducted from the routine score if an athlete has made deliberate use of the bottom of the pool to assist another athlete. No penalty will be applied when the contact with the bottom of the pool results from the swimmer's self-protection from injuries by impact.

**18.9.9** Base Mark: All Free Elements (Hybrids and Acrobatics) have a calculated Base Mark that is the minimum Degree of Difficulty that will be applied if one (1) or more components of the element is not performed or is not in conformance to what is declared in the Coach Card.

**18.9.10** Exceeding Number of Predetermined Elements: A two (2) point penalty shall be deducted from the Elements score for each element exceeding the predetermined number assigned to the particular event and category.

**18.9.11** General Requirement # 4, 5: a Base Mark shall be applied for each violation of General Requirement #4 or 5 in Appendix 4:

General Requirement #6: an eight (8) point penalty shall be deducted from the Routine score for each violation of the General Requirement #6 in Appendix 6.

4 - A maximum of **two (2)** acrobatics from any group (A, B, C or P) may be performed. If a third from the same group is performed that acrobatic will go to base mark.



5 - Acrobatics must not be repeated (see 18.9.13)

6 - The Routine must portray a Theme, which must be declared on the Card.

**18.9.12** Acrobatic Required Element # 1: An eight (8) point penalty shall be deducted from the Elements Score for each violation of Acrobatic Required Element #1 as specified in Appendix 4:

Seven (7) acrobatic movements: one from each acrobatic group (A, B, C, P), and three (3) more of free choice as per the general requirements.

**18.9.13** Repetition of Team Acrobatic: a Base Mark shall be applied for a repeated acrobatic.

For Team - Must not repeat the same acrobatic is defined as:

For Group A – can't repeat the same position/s (as P1 or as P2), with the exception of the third position bonus

For Group B – can't repeat the same construction, can't repeat the same type of connection (grip)

For Group C – can't repeat the same construction

For Group P – can't repeat the same construction + can't repeat the same type of connection (grip), AND can't repeat the same position/s (as P1 or as P2), with the exception of the third position bonus

**18.9.14** Synchronisation errors and penalty values

For all routines, the sum of all synchronisation errors (unequal actions) observed by the Synchronisation Technical Controllers (STC), (each factored by its assigned value) will be deducted from the Elements Score. Types of Synchronisation errors and penalty values are:

Small	0.1 points
Obvious	0.5 points
Major	3.0 points

The description of small, obvious, and major synchronisation errors (unequal actions) is detailed in the Scoring Synchronisation Guide. Maximum deduction can reduce the Elements score to zero (**0**), but not to a negative Elements score.

**18.10** Free Combination Routine

**18.10.1** Deck Walk-on: An eight (8) point penalty shall be deducted from the routine score if the time limit of 30 seconds for the deck walk-on is exceeded.

**18.10.2** **Deck Movements:** An **eight (8)** point penalty shall be deducted from the routine score if the time limit of ten (10) seconds for deck movements is exceeded.

**18.10.3** **New Start:** A **two (2)** point penalty shall be deducted from the routine score if a routine is interrupted by an athlete during the deck movements and a new start is allowed.

**18.10.4** Overall Routine Time: An eight (8) point penalty shall be deducted from the routine score if there is a deviation from the specified routine time limit allowed (less or more than) for the routine and in accordance with Part Seven, Article 25.5 - Age Group Time Limit Rules.

**18.10.5** Stop Swimming/Use of Pool Wall: If one (1) or more athlete(s) stops swimming or makes clear support use of the pool wall before the routine is completed, the routine will be disqualified. The Referee shall assess if the cessation is caused by circumstances beyond the control of the athlete. The Referee may allow the routine to be re-swum during the session.

**18.10.6** Deliberate Use of Bottom to Propel: An eight (8) penalty shall be deducted from the routine score if an athlete has made deliberate use of the bottom of the pool during a routine to propel themselves.

**18.10.7** Deliberate Use of Bottom to Assist: An eight (8) point penalty shall be deducted from the routine score if an athlete has made deliberate use of the bottom of the pool to assist another athlete. No penalty will be applied when the contact with the bottom of the pool results from the swimmer's self-protection from injuries by impact.



- 18.10.8** Base Mark: All Free Elements (Hybrids and Acrobatics) have a calculated Base Mark that is the minimum Degree of Difficulty that will be applied if one (1) or more components of the element is not performed or is not in conformance to what is declared in the Coach Card.
- 18.10.9** Exceeding Number of Predetermined Elements: A two (2) point penalty shall be deducted from the Elements score for each element exceeding the predetermined number assigned to the particular event and category.
- 18.10.10** General Requirements 2-5: An eight (8) point penalty shall be deducted from the Routine Score for violations of each General Requirement in Appendix 5.
- 18.10.11** Required Element #1: A two (2) point penalty shall be deducted from the Elements Score for each violation of Free Combination Required Element #1 in Appendix 5:
- At least two (2) parts must have fewer than three (3) competitors and at least two (2) parts must have all competitors
- 18.10.12** Required Element #2 – Youth Free Combination: a Base Mark shall be applied for each violation of Youth Free Combination Required Element #2 in Appendix 5:
- Four (4) Team Acrobatics with DD safety limit (free choice but must not repeat the same acrobatic)
  - One (1) x DD Solo Hybrid
  - One (1) x DD Duet Hybrid
  - Two (2) x Team DD Hybrid (must be executed with a minimum of four (4) athletes)
  - One (1) x Team choreography hybrid with no DD (ie factor of 1.0) must be executed with a minimum of four (4) athletes
  - Element parts can not occur simultaneously (ie Team Acrobatic occurs while solo hybrid starts)
- 18.10.13** Required Element # 3 – 12U Free Combination: a Base Mark shall be applied for each violation of 12U Free Combination Required Element #3 in Appendix 5:
- Three (3) Team Acrobatics with DD safety limit (free choice but must not repeat the same acrobatic)
  - One (1) x DD Solo Hybrid
  - One (1) x DD Duet Hybrid
  - Two (2) x Team DD Hybrid (must be executed with a minimum of four (4) athletes)
  - One (1) x Team choreography hybrid with no DD (ie factor of 1.0) must be executed with a minimum of four (4) athletes
  - Element parts can not occur simultaneously (ie Team Acrobatic occurs while solo hybrid starts)
- 18.10.14** Required Elements #4-5: a Base Mark shall be applied for each violation of Free Combination Required Elements #4-5 in Appendix 5:
- 4 - 12U and Youth Team Acrobatic Safety Limits for Free Combination is as follows. Acrobatic elements cannot have a DD higher than the Total DD (MAX):
- For Youth:* Group A (2.7), Group B (2.8), Group C (2.8) and Group P (3.0). All DD limits are inclusive of Base Mark value of 0.5.
- For 12U:* Group A (2.5), Group B (2.6), Group C (2.6) and Group P (2.8). All DD limits are inclusive of Base Mark value of 0.5.
- 5 - Acrobatics must not be repeated (see 18.10.15)
- 18.10.15** Repetition of Team Acrobatic: A Base Mark will be applied for any repetition of acrobatics.
- For Team - Must not repeat the same acrobatic is defined as :
- For Group A – can't repeat the same position/s (as P1 or as P2), with the exception of the third position bonus
- For Group B – can't repeat the same construction, can't repeat the same type of connection (grip)
- For Group C – can't repeat the same construction
- For Group P – can't repeat the same construction + can't repeat the same type of connection (grip), AND can't repeat the same position/s (as P1 or as P2), with the exception of the third position bonus
- 18.10.16** Synchronisation errors and penalty values



For all routines, the sum of all synchronisation errors (unequal actions) observed by the Synchronisation Technical Controllers (STC), (each factored by its assigned value) will be deducted from the Elements Score. Types of Synchronisation errors and penalty values are:

Small	0.1 points
Obvious	0.5 points
Major	3.0 points

The description of small, obvious, and major synchronisation errors (unequal actions) is detailed in the Scoring Synchronisation Guide. Maximum deduction can reduce the Elements score to zero (**0**), but not to a negative Elements score.

- 18.10.17** Exceeding Free Hybrid maximums: If 5x per family or 3x per technique is exceeded in a Free Hybrid, the DTC shall apply a Base Mark to the Free Hybrid.
- 18.10.18** Not Including a Skill from every Family: An eight (8) point penalty shall be deducted from the Elements score for NOT including a skill from every family in the routine (with the exception of connections in Solo). All routine members must perform that skill in the same declaration on the coach card (not factored) if performed during the duet or team free hybrids.
- 18.10.19** Should a Federation use a code that has been reserved for another country, they will receive a basemark for that code.
- 18.10.20** A **half (0.5)** point penalty shall be deducted from the total score for each athlete less than **ten (10)** (see Part Seven, Article 13.3).





## 19 CALCULATION OF THE ROUTINE RESULTS

### 19.1 Calculation procedure for all routines:

$EL1DD*Ex + EL2DD*Ex + \dots + ELnDD*Ex - Sy$  errors penalty - other penalties

#### = Elements score

CH/MU score + EP score + Tr - other penalties

#### = Artistic Impression score

Elements score + Artistic Impression score - other penalties

#### = Routine score

The score for each element is calculated as follows: the highest and the lowest awards for each score are cancelled (one high, one low). The three (3) remaining awards are added, and the sum divided by three (3). The result is multiplied by its correspondent DD.

For each of the three (3) Artistic Impression scores the highest and the lowest awards for each score are cancelled (one high, one low). The three (3) remaining awards are added.

- EL = Element (either required or free)
- DD = Sum of values of each element component and bonuses + Base Mark for Free Elements (all in Hybrid Difficulty Table); assigned DD for Technical Required Elements #1 to #5
- Ex = Execution score
- n = Total number of Elements in an event (see Part Seven, Appendix 3)
- CH/MU = Choreography and Musicality
- EP = Performance
- Tr = Transitions

**World Aquatics will manage all final DD values. Factoring can be applied. World Aquatics reserves the right to adjust if required.**

**19.2** The Routine Score shall be the sum of the Elements score and Artistic Impression scores less any penalty deductions in Part Seven, Article 18.

## 20 FINAL RESULT

**20.1** The final Figure result shall be that of the athletes who actually swam the Free Routine. For exceptions see rule Part Seven, Article 12.3.4.

**20.2** The final result is determined by adding the final score of each performed session; if both Preliminary and Final Routine sessions are held, the Routine score from the Final session shall replace that of the Preliminary session to determine the Final result.

**20.2.1** In events that include one (1) session – Open Acrobatic Routine or Open Free Combination, Free Routine, Technical Routine or Figures - the result shall be the score of that session.

**20.2.2** In events that include two (2) sessions – Figures and Free Routine or Technical Routine and Free Routine – the results shall be the sum of each session.

**20.2.3** In events that include three (3) sessions – Technical Routine, Free Routine and Open Acrobatic Routine – the results shall be the sum of each session.

**20.3** In the case of ties (calculated to four (4) decimals) in Women Solo, Men Solo, Women Duet, Mixed Duet, Open Team, Open Free Combination and Open Acrobatic Routine, the following shall apply.

If a decision has to be made to go to Finals or draws, to be qualified, or to be promoted/ demoted, the following procedure will be used:

For all routines:



The highest Elements score shall decide. If there is still a tie, the highest Choreography and Musicality score in the Artistic Impression panel determines the position.

If there is still a tie, the highest verified total declared degree of difficulty in the Elements panel will decide.

For events with combined results (Technical, Free and Open Acrobatic Routines) Example: Olympic Games, the following procedure will be used:

- The higher Free Routine score of the final result shall decide.
- If there is still a tie, the Elements score of the Free Routine determines the position.
- If there is still a tie, the highest Choreography and Musicality score in the Artistic Impression panel of the Free Routine determines the position.
- If there is still a tie, the highest Elements score from the Technical Routine shall decide.

**20.4** DNS is when the solo/duet / mixed duet /team/ open team/acro or combo were registered to participate in the event but did not show up in the last call room for their designated start time. In artistic swimming someone may say that the swimmer or team "scratched" from the event which is generally another way of saying DNS, the terms DNS vs scratched in artistic swimming may be used interchangeably. DNS results will be displayed at the bottom of the list of final results for an artistic swimming event, after all of the other competitors who have an official score .

**20.5** DSQ The Referee shall disqualify any artistic swimmer solo / duet / mixed duet team/ open team/ /acro / or combo for any violation of the rules that they personally observe. The Referee may also disqualify any athlete for any violation reported to him by other authorised officials. All disqualifications are subject to the decision of the Referee. DSQ results will be displayed at the bottom of the list of final results for an artistic swimming event after all of the other competitors who have an official score.

## **21 OFFICIALS AND DUTIES**

**21.1** Officials shall be recommended by World Aquatics. The evaluations of the Judges, their overall world ranking, bias scores, and participation in World Aquatics events in the past two (2) seasons will be considered. Continental representation will be considered, in selecting Judges, however the best Judges will be placed on Final events. These selections shall be final except for emergency situations (see Part Seven, Article 22.3 and 22.4). All Officials are required to be onsite one full day prior to the start of the competition they are officiating at in order to view the practice sessions.

**21.2** The required officials shall be:

**21.2.1** A Referee

**21.2.2** One Assistant Referee for each panel of Judges in figures competitions.

**21.2.3** For World Aquatics events and Olympic Games one (1) Difficulty Technical Controller (DTC) and two assistant (2) Technical Controllers (DATC) are required.

**21.2.4** For World Aquatics events and Olympic Games three (3) Synchronisation Technical Controllers (STC) are required.

**21.2.5** Each Figure panel shall consist of five (5) Judges. In Routines two (2) panels of five (5) Judges shall be used. At World Aquatics competitions and Olympic Games, Judges shall be chosen from the World Aquatics lists of Judges, and Technical Controllers shall be selected from the list of World Aquatics Technical Controller experts.

**21.2.6** For each Figure panel – a Panel Referee (1), a Panel Marshall (1) and two (2) to three (3) scorers.

**21.2.7** For routines – two (2) timers

**21.2.8** A World Aquatics approved Sound Center Manager

**21.2.9** A World Aquatics approved Announcer

**21.2.10** A World Aquatics approved Under Water Camera Operator.

**21.2.11** A World Aquatics approved Video Replay System for Technical Controllers

**21.2.12** One (1) to two (2) appointed World Aquatics Evaluators. shall be selected from the trained group of World Aquatics Evaluators.



**21.2.13** Other officials as deemed necessary.

## **22 REFEREE**

**22.1** The Referee work in collaboration with the World Aquatics Delegate or Commission and Evaluators. The Referee shall enforce the decisions of the group. Referees will take attendance and provide the judges with logistic information for the session (for example if there is break or if there are any scratches). The Evaluators will lead all Judge panel discussions and Judge debriefs.

The Referee shall be responsible for:

- 1) Draw for order of appearance in all sessions.
- 2) Recording changes of athletes prior to each session.
- 3) Checking the electronic scoring system.
- 4) Checking the computer results.
- 5) Ensure that an Evaluators program is provided.
- 6) Ensure Coach Cards have been uploaded for the Technical Controllers
- 7) Ensure Judges have Routine DD sheet for each event.
- 8) Be in communication with the Announcer, Medical personel, Sound Center Manager, lifeguards and Assistant Referee.
- 9) Receive Coach Card changes and ensure distribution to Scorer, Technical Controllers, Announcer, media and broadcast.

**22.2** The Referee shall be responsible for the running of the deck and flow of the event. Rules will be enforced by the Referee after collaboration with the World Aquatics Delegate/Commission. The Evaluators may be consulted as necessary. The Referee in collaboration with the World Aquatics Delegate/Commission are responsible for questions and decisions of the events relating to the conduct of the event.

**22.3** The Referee shall ensure that all the necessary officials are in their respective positions to conduct the session. They ensure the officials have their assignments for each routine and are provided with a programme sheet for each competitor.

**22.4** The Referee may appoint reserve Judges for any persons who are absent, incapable of acting or found to be inefficient or biased after consultation with the World Aquatics Commission/Delegate.

**22.5** In emergencies, the Referee is authorized to assign a reserve Judge.

**22.6** Referees ensure that the athletes are ready and signal for the start of the accompaniment. They shall approve the penalties resulting from any infraction to the rules. The Referee and World Aquatics Delegate/Commission shall approve the results before announcements.

**22.7** The Referee may intervene in the event at any stage to ensure that the World Aquatics regulations are observed and shall adjudicate all protests in collaboration with the World Aquatics Delegate/Commission related to the session in progress.

**22.8** The Referee shall recommend disqualification of any athlete for any violation of the rules that they personally observe by reporting the offender to the World Aquatics Delegate/Commission.

**22.9** The Referee must attend the Team Leaders meeting and ensure logistics for the event are in place.

**22.10** The Referee runs the draws at the Team Leaders' meetings. Draws will commence after all media information sheets have been submitted to the OC on each routine.

## **23 OTHER OFFICIALS**

**23.1** Other official(s) shall carry out duties assigned by the Referee.

## **24 DUTIES OF ORGANIZER**

**24.1** The Member Federation holding the competition is responsible for:



- 24.1.1** Pool specifications and related regulations listed in rules Part Seven, Articles 27.1 to 27.4. Changes to requirements must be approved by World Aquatics.
- 24.1.2** Providing suitable sound equipment approved by World Aquatics.
- 24.1.3** Providing four (4) underwater speakers for competition pool and four (4) underwater speakers for the practice pool.
- 24.1.4** Produce program sheets for each routine for Judges and Coach Cards for Technical Controllers.
- 24.1.5** Preparing a list of entries and judging forms.
- 24.1.6** Providing event information electronically to TASC, Officials, Coaches and media.
- 24.1.7** Providing the Judges for Figure sessions with a means of signalling scores. When automatic Officiating Equipment is used, each Judge shall be provided with flash cards in case of technical failure.
- 24.1.8** Ensuring that practice periods prior to the start, shall apply at all World Aquatics competitions.
- 24.1.9** Ensuring a World Aquatics approved scoring system is used.
- 24.1.10** Ensuring that electronic marks and display/scoreboard is be used for World Aquatics events. The results display information score board must show placing in previous program (Preliminaries or Technical Routine) and current placing in current program (Finals or Free Routine) and an overall current placement.
- 24.1.11** Ensuring that video records of all sessions and underwater video is available if required for all routines to enable checking the use of the bottom of the pool.
- 24.2** The information bulletins for all Artistic Swimming competitions must include the following information:
- 1) The place of the event and the name of the pool
  - 2) The date and time of the competition when it is held
  - 3) Names of World Aquatics President, World Aquatics Staff, World Aquatics Delegate/Commission, World Aquatics Bureau Liaison
  - 4) List of Federations participating by event entries
  - 5) Event schedule
  - 6) Transportation schedule for athletes, officials and TASC. The schedule will be posted at the venue and in the lobby of the hotels
  - 7) Officials participating in the event
  - 8) Pool dimensions with specific reference to the depth of the water, the water level below deck, position of diving boards, ladders, etc. A cross section drawing of the pool is desirable, and diagrams of the pools for figure session and routine sessions. In case the pool specifications are not according to Facilities Rules, diagrams and cross section drawing are obligatory and must be sent with the meet invitation.
  - 9) Temperature of water
  - 10) Gel station for athletes / Mirrors for athletes
  - 11) Stretch room for athletes
  - 12) Lockers for Judges
  - 13) Practice pool that mimics competition pool with platform
  - 14) Training schedules ensuring all athletes have equal conditions prior to start of event
  - 15) Transportation schedules for pick up and departure to airport
  - 16) Assistance with local visa/ covid requirements
  - 17) Link to live streaming and results
  - 18) Medical Services Information
  - 19) Organize Gala Water Show
- 24.3 Other duties:**
- 24.3.1** Markings of bottom and sides of the pool.
- 24.3.2** Position of audience with reference to the pool and designated VIP seating area.
- 24.3.3** Type of lighting
- 24.3.4** Open space for entrance and exit, to include designated starting point for walk-ons.
- 24.3.5** Types of sound equipment available.



- 24.3.6** Alternative facilities, if required.
- 24.3.7** Schedule of events, indicating which sessions (per Part Seven, Article 4) will be included in the program (Part Seven, Article 5) and stating whether Preliminaries and Finals will be held according to Part Seven, Article 7.1 and 7.2.
- 24.3.8** Ensure Gala water show is included at the end of the competition. Participating athletes must perform a new routine of no less than 1:00 minute and no longer than 1:30 minute in duration. Costumes, make up props and lighting are welcome. Gala Show program must be approved by World Aquatics.

## **25 AGE GROUP RULES**

### **25.1 General**

World Aquatics Rules of competition will apply in all Age Group competitions.

### **25.2 Age Categories**

**25.2.1** All Age Group athletes remain qualified from 1st January to the following 31st December at the age they are at the close of day (23:59) on 31st December of the year of the competition.

#### **25.2.2 Age Groupings for Artistic Swimming are:**

- 12 and under
- Youth (13 – 15 years of age)
- Junior (15-19 years of age)
- Senior 15 +above

#### **25.2.3 Men Age Groupings for Artistic Swimming are:**

- 12 and under
- Youth (13 – 16 years of age)
- Junior (15 – 20 years of age)
- Senior 15 + above

### **25.3 Age Group figure sessions**

**25.3.1** In the 12 and Under age category, each athlete in Women Solo, Men Solo, Women Duet, Mixed Duet, and Open Team must perform four (4) figures: the two (2) compulsory figures and one (1) group of two (2) figures drawn from the list described in the Appendix I of these rules. Each athlete in Open Free Combination may perform four (4) figures selected by the above-described procedure.

In the Youth category, each athlete in Women Solo, Men Solo, Women Duet, Mixed Duet, and Open Team must perform a group of two (2) figures from the set of four (4) figures drawn from the list described in Appendix 5 of these rules. Each athlete in Open Free Combination may perform the two (2) figures selected by the above-described procedure.

A group or set of two (2) groups of Figures from the World Aquatics Figures 2022-2025 in Appendix I shall be drawn by the Organising Committee according to Part Seven, Article 8.3.

#### **25.3.2 Figure lists:**

The Figure groups for 12 and under and the 3 sets of 2 groups of figures with 2 figures in each group with identical DD for Youth age groups are listed in Appendix I of these World Aquatics Artistic Swimming Rules. Participating Federations/Clubs may also by mutual consent choose from other Age Group for the level of ability of the athletes entered in the competition.

**25.3.3** For each athlete in 12 and under and Youth age groups the final result of the figures session will be divided by the total degree of difficulty of the Figures performed and multiplied by 10 (see Part Seven, Article 12.2).

**25.4** In a Women Duet, Mixed Duet or Open Team event of the 12 and under and Youth age categories, all competitors must compete in their own Age Group and must swim the Figure groups assigned by the draw (See Part Seven, Articles 8.3 and 8.4).

**25.5** The time limits for different age groups, including ten (10) seconds of deck movements, shall be:

#### **25.5.1 12 and Under / Youth**



Category	Time limit
<b>Solo</b>	2:00 minutes
<b>Women Duet/Mixed Duet</b>	2:30 minutes
<b>Open Team</b>	3:00 minutes
<b>Open Free Combination</b>	3:00 minutes

**25.5.2 Junior**
**25.5.2.1 Junior Free Routines**

Category	Time limit
<b>Solo</b>	2:15 minutes
<b>Women Duet/Mixed Duet</b>	2:45 minutes
<b>Open Team</b>	3:30 minutes
<b>Open Acrobatic Routine</b>	3:00 minutes

**25.5.2.2 Junior Technical Routines**

Category	Time limit
<b>Solo</b>	2:00 minutes
<b>Women Duets / Mixed Duet</b>	2:20 minutes
<b>Open Team</b>	2:50 minutes

There shall be an allowance of five (5) seconds less or plus the allotted time limit.

## 26 SWIMWEAR AND WEARABLES

In routines the swimwear must conform to I. Part One, Article 7 and the following rules.

**26.1** In the event that the Referee thinks the athlete(s) swimwear does not conform, the athlete will not be permitted to compete until in conformance. Swimwear may however represent character or theme of the music they are swimming to. The swimwear must not give the effect of excessive nudity inappropriate for the sport. Artistic Swimming swimwear must be dignified and appropriate for athletic competition.

Swimwear for men in Artistic Swimming shall not extend above the navel nor below the upper thigh.

No swimmer shall be permitted to use or wear any device or swimsuit that may aid his/her speed, buoyancy or endurance during a competition. The use of technology and automated data collection devices is permissible for the sole purpose of collecting data. Automated devices shall not be utilised to transmit data, sounds, or signals to the swimmer and may not be used to aid their speed and must be approved by World Aquatics prior to being used. Any kind of tape on the body is not permitted unless approved by the World Aquatics Sports Medicine Committee.

**26.2** The use of accessory equipment, goggles or additional clothing is not permitted unless required by medical reasons. In the event that the Referee observes or is informed by Assistant Referee that the athlete(s) does not conform, the athlete will not be permitted to compete until in conformance.

**26.3** Nose clips or plugs may be worn.

**26.4** For safety reasons only small stud jewelry is permitted. Athletes must remove any dangling jewelry, or dangling items from headpieces or swimwear prior to the start of the event.

**26.5** Theatrical make-up shall not be worn. Natural makeup that represents the athlete's unique personality and/or the theme of their routines may be used.

## 27 ARTISTIC SWIMMING FACILITIES AND EQUIPMENT

**27.1 Artistic Swimming Facilities****27.1.1 Figure Section**

The areas for figure competition in Part Seven, Article 27.1.1 can occupy the same area of the pool as that used for routine competition in Part Seven, Article 27.1.2 approved by TASC.

**27.1.2 Routine Section**

For the routine section of the competition a minimum area of 15 metres by 25 metres is required, within an area of which 12 metres by 12 metres must have a minimum depth of 3.0 metres. The depth of the remaining area shall be 2.0 metres minimum. To be decided on a case by case basis by World Aquatics in case of non-compliance.

**27.1.3 Depth**

The pool depth shall be as detailed in Part Seven, Article 27.1.2.

Where the water depth is more than 2.0 metres, the depth at the pool wall may be 2.0 metres and then sloped down to reach the general depth at 1.2 metres maximum from the pool wall.

**27.1.4 Markings**

If there are no markings as described in Part Two, Article 16.2.15, the floor of the pool must be marked with contrasting lines in one direction, following the length of the pool as detailed in: *Artistic Swimming Diagram Annex 1*.

**27.1.5 Water Conditions**

**27.1.5.1** The water must be of sufficient clarity for the bottom of the pool to be visible.

**27.1.5.2** The water temperature shall not be less than 27° Centigrade.

**27.1.6 Lighting**

The minimum light intensity at the level of 1 metre above the water surface shall not be less than 600 lux.

Sources of natural and artificial illumination shall be provided with controls to prevent glare for judges platforms and the starting platform.

**27.1.7 Starting Platform**

Starting platform is recommended 1.0 metres in height but not less than 0.5 metres.

The surface of the platform should be covered in a slip-resistant material suggest a quick drying water proof carpet.

The athletes entrance should always be centre-stage.

**27.2 Artistic Swimming Facilities for Olympic Games and World Aquatics Championships****27.2.1 General requirement**

The Field of Play for Artistic Swimming in Olympic Games and World Aquatics Championships as detailed in: *Artistic Swimming Diagrams, Annex AS1 and AS 2*

**27.2.2 Routine Section**

For the routine section of competition at Olympic Games and World Aquatics Championships a minimum area of 30.0 metres by 20.0 metres is required.

**27.2.3 Depth**

The depth of the water shall be consistently not less than 3.00 metres.

**27.2.4 Markings**

If there are no markings as described in III.16.2.15, the floor of the pool must be marked with contrasting lines in one direction, following the length of the pool as detailed in: *Artistic Swimming Diagram, Annex 1*.

**27.2.5 Water Conditions**

**27.2.5.1** The water must be of sufficient clarity for the bottom of the pool to be visible.



**27.2.5.2** The water temperature shall not be less than 27° Centigrade.

**27.2.6 Lighting**

The light intensity at the level of 1 metre above the water surface shall not be less than 1500lux.

Sources of natural and artificial illumination shall be provided with controls to prevent glare for judges platforms and the starting platform.

**27.2.7 Starting Platform**

Starting platform shall be 0.7 metres in height with a tolerance of ±1cm.

The surface of the platform should be covered in a slip-resistant material suggest a quick drying water proof carpet. *See Artistic Swimming Diagrams, Annexes 1 and 2.*

**27.2.8 Judges Platform**

The Judges Platform must have tables and chairs and be of a minimum height of 0.6 metres. *The platforms should be no more than 2 metres from the edge of the pool.*

*See Artistic Swimming Diagrams, Annex 1 and AS2.*

**27.2.9 Practice warm up pool**

Practice warm up pool shall have a minimum area of 25 metres by 25metres or 30metres by 20 metres with a depth of 3 metres.

A sound reproduction system meeting the requirements set in Part Seven, Article 27.3 shall be available.

**27.2.10 Dry Land Training**

A Dry land training stretch area must be provided for the athletes with mats.

**27.3 Automatic Officiating Equipment for Artistic Swimming**

The minimum installation consists of:

**27.3.1** same number of score recorder units as judges (figure: 5 up to 28; routine 5 up to 15)

**27.3.2** the results may only be transferred after confirmation by the referee or appointed official.

**27.3.3** result unit (computer) with result recording and backup system. Only World Aquatics approved programmes and systems are allowed.

**27.3.4** print out system for all recorded information, start lists and result lists;

**27.3.5** A judge's evaluation system based on the recorded results. The World Aquatics TASC approved evaluation programme is required.

**27.3.6** scoreboard control unit with a scoreboard; of a minimum of 10 lines containing 32 digits (or scoreboard as described in Artistic Swimming Facilities Rules. The scoreboard must be able to display all recorded information and the running time;

**27.3.7** for each judge flash cards in case of failure of the electronic system.

**27.3.8 Timing System**

An automated timing system with two (2) independent timers timing walk-on time, deck movement time and overall time. The timers should be placed close to the result secretariat.

**27.3.9 Under water review system**

Underwater camera is required with mounting and harness to the wall or bottom depending on the type The system must have video server or a computer control centre with data storage with the capacity for immediate slow motion replay. A monitor for the TASC to perform immediate reviews must be available.

**27.3.10 Routine and Figure review system**

2 to 4 cameras in defined positions with mounting and harness video server or computer control centre and data storage with the capacity for slow motion instant replay must be available.

**27.4 Sound Equipment and Presentation Standards for Artistic Swimming**





The sound equipment should include, at minimum:

**27.4.1 Amplifier-mixer system**

Mixer should have at least 16 inputs and 6 outputs (LR (Left-Right channels) PA, LR Speaker system on the field of competition, 2 outputs Spare/or for Broadcasting). Amplifiers should be suitable for used speakers.

**27.4.2 A sound reproduction system**

**27.4.2.1** High quality microphones and microphone stations for announcements and ceremonies.

**27.4.2.2** High quality air speakers (AS) of size, number and placement to obtain uniform clear sound to the field of competition area. And should be able to produce 105 dB SPL (sound pressure level) A without distortion. The maximum SPL shall not exceed 125 dB SPL A. Speakers frequency response should be at least 40Hz-16kHz.

**27.4.2.3** High quality air speakers (AS) of size, number and placement to obtain uniform clear sound to the start podium of competition area. And should be able to produce 105 dB SPL A without distortion. The maximum SPL shall not exceed 125 dB SPL A. Speakers frequency response should be at least 40Hz-16kHz.

**27.4.2.4** All air speaker (AS) in the field of competition should be «passive» (without built-in amplifier) to avoid risk of electrical shock.

**27.4.2.5** UWS (Under Water Speaker) for clear and uniform underwater sound above. UWS should be able to produce 98dB A without distortion. The maximum SPL shall not exceed 110 dB SPL A. UWS frequency response should be at least 200Hz-10kHz. Isolation and impedance matching transformer systems for the UW speakers.

**27.4.2.6** DSP (Digital Sound Processor) to make amplitude frequency characteristic and delay corrections in between AS and UWS. DSP should have at least 2 inputs and independent 6 outputs (or 3 Stereo independent outputs). Each output should have HPF (High Pass Filter), LPF (Low Pass Filter), GEQ (Graphic equalizer) and/or Parametric equalizer, compressor/limiter, Delay (minimum 5 seconds).

**27.4.3** PA (Public Address) System (Sound reproducing system for spectators)

**27.4.3.1** The sound system shall be capable to cover spectators seats at least with 110 dB A with deviations in overall direct sound levels across the spectator seating area not exceeding +/- 3 dB A. The maximum SPL shall not exceed 125 dB SPL A.

**27.4.3.2** STI PA (speech transmission index for PA systems) should be in 0,5-1.0 STI.

**27.4.3.3** The PA system shall provide enough headroom to compensate for the atmospheric loss of high frequencies.

**27.4.3.4** The PA system should have a minimal impact to the field of competition to avoid sound delay problems.

**27.4.4** Sound volume (decibel) meter for monitoring music sound levels both above and under water.

**27.4.5** Patch cords for interconnecting equipment properly, speaker extension lines adequate for placing speakers for optimal sound distribution.

**27.4.6** Fusing systems as needed to protect speakers and other equipment.

**27.4.7** Grounding lines to ensure safe grounding of all equipment.

**27.4.8** Safety materials to minimize potential of injury to person or equipment from stepping on or tripping over electrical or speaker lines.

**27.4.9** A stopwatch.

**27.4.10** Tools and meters as needed for initial special hookups and emergency repairs.

**27.4.11** Systems for communication between officials and sound desk. Five (5) headsets must be available.

**27.4.12** A system for monitoring and recording underwater sound continuously.



**27.5 Annexes**

**Annex 1 - Diagram – Artistic Swimming Field of Play for Olympic Games and World Aquatics Championships**

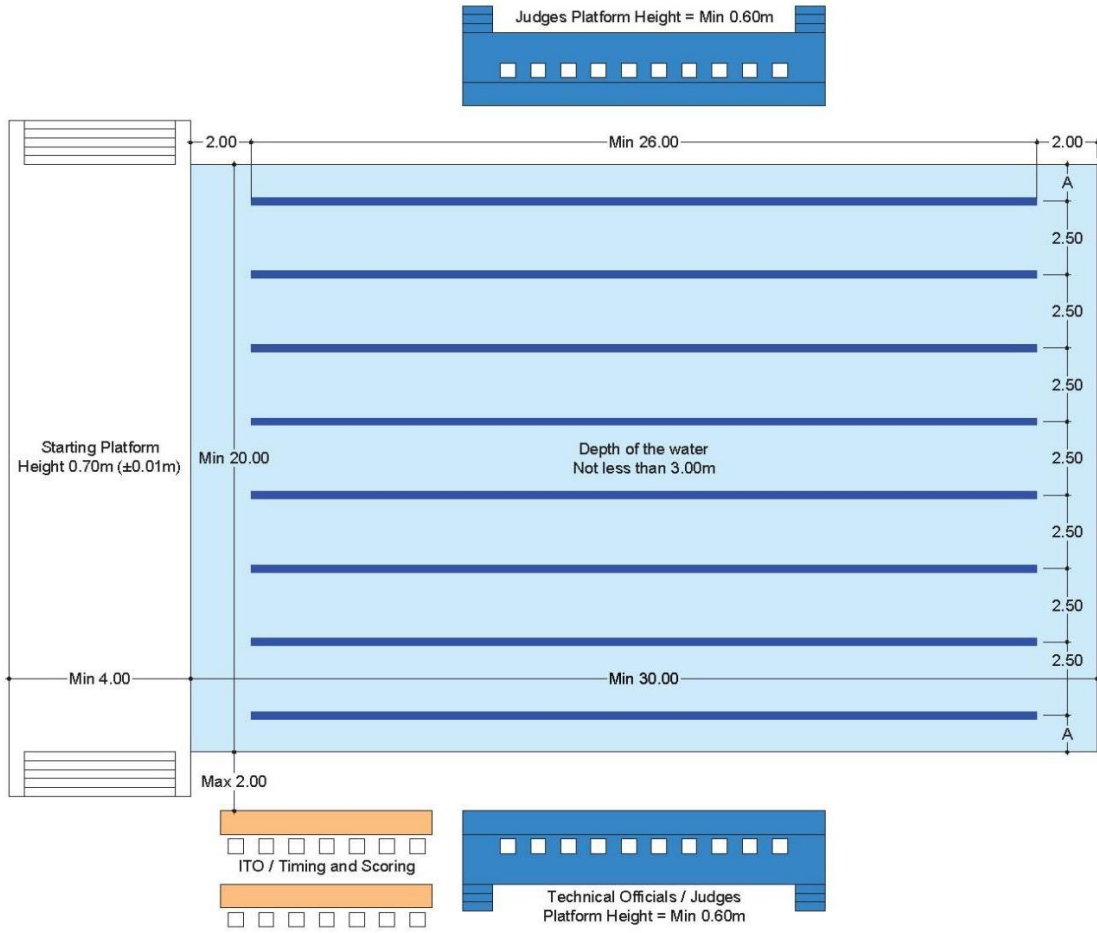

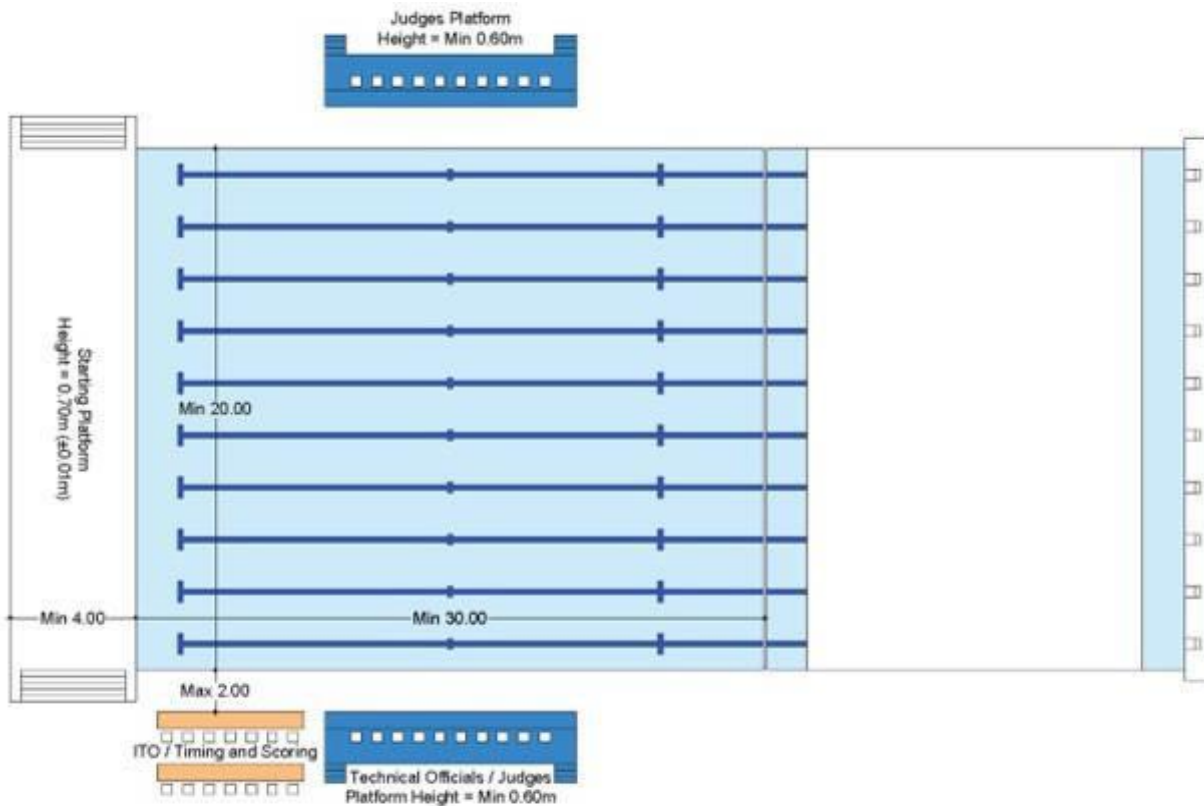
**Annex 2 - Diagram – Artistic Swimming Field of Play for Olympic Games and World Aquatics Championships**

## 28 MEDICAL AND SAFETY SPECIFIC REQUIREMENT FOR ARTISTIC SWIMMING

The Medical Requirements are described in the Part One, Article 9.2. However, each sport has unique components.

### 28.1 Location of the FoP First Aid Treatment Area

FoP First Aid Treatment Area should be positioned near the starting platform and athletes exit.

### 28.2 Water Rescue and Lifeguards

During Competition, three (3) lifeguards are required. One (1) lifeguard shall be positioned next to the coach of the competing swimmer(s) to react immediately in an emergency. Two (2) lifeguards should be positioned on different sides of the pool to cover the whole competition area.

At the warm-up pool, a minimum of at least two (2) lifeguards are required.

**29 APPENDICES**

- 29.1 Appendix 1 - World Aquatics Basic Position, Basic Movement and Figures
- 29.2 Appendix 2 - Technical Routines
- 29.3 APPENDIX 3 - Set Numbers of Elements for Routines
- 29.4 APPENDIX 4 - REQUIRED ELEMENTS FOR ACROBATIC ROUTINE
- 29.5 APPENDIX 5 - REQUIRED ELEMENTS FOR THE FREE COMBINATION
- 29.6 APPENDIX 6 - HYBRID CATALOGUE
- 29.7 APPENDIX 7 - ACROBATICS CATALOGUE
- 29.8 APPENDIX 8 - IDENTIFICATION OF SYNCHRONISATION ERRORS
- 29.9 APPENDIX 9 - ARTISTIC SWIMMING WORLD RANKING





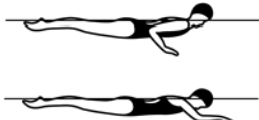

**29.1 Appendix 1 - World Aquatics Basic Position, Basic Movement and Figures**
**29.1.1 Basic Body Position (BP)**

In all basic body positions:

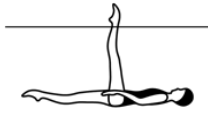

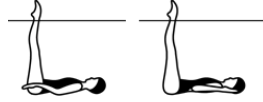

- a) arm positions are optional,
- b) toes must be pointed, ankles must be extended,
- c) the legs, trunk and neck are fully extended unless otherwise specified and
- d) diagrams are a guide only. If there is a discrepancy between a diagram and a written description, the English written Body Position description prevails.

<b>1 BACK LAYOUT POSITION</b>	
<p>Body extended with face, chest, thighs and feet at the surface of the water. Head (ears specifically), hips and ankles in horizontal alignment.</p>	
<b>2 FRONT LAYOUT POSITION</b>	
<p>Body extended with head, upper back, buttocks and heels at the surface of the water. Unless otherwise specified, face may be in or out of the water.</p>	



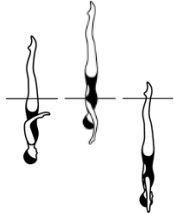
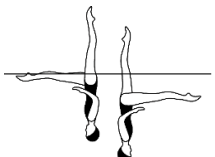
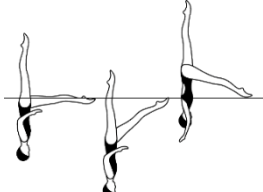







<b>3 BALLET LEG POSITION</b>	
<b>a) Surface</b> Body in <b>Back Layout Position</b> . One leg extended perpendicular to the surface of the water	
<b>b) Submerged</b> Head, trunk and horizontal leg parallel to the surface of the water. One leg perpendicular to the surface with the water level between the knee and the ankle.	
<b>4 FLAMINGO POSITION</b>	
<b>a) Surface</b> One leg extended perpendicular to the surface of the water. The other leg bent with the mid-calf opposite the vertical leg. Foot, shin and knee at and parallel to the surface of the water. Face at the surface of the water.	
<b>b) Submerged</b> Trunk, head, shin and foot of the bent leg parallel to the surface of the water. 90° angle between the trunk and extended leg. Water level between knee and ankle of the extended leg.	
<b>5 BALLET LEG DOUBLE POSITION</b>	
<b>a) Surface</b> Legs together and extended perpendicular to the surface of the water. Head in line with the trunk. Face at the surface of the water.	
<b>b) Submerged</b> Trunk and head parallel to the surface of the water. 90° angle between the trunk and the extended legs. Water level between knees and ankles of the extended legs.	



<b>6 VERTICAL POSITION</b>		
<p>Body extended perpendicular to the surface of the water; legs together, head downward. Head (ears specifically), hips and ankles in line</p>		
<b>7 CRANE POSITION – this position is currently not performed in any World Aquatics figure.</b>		
<p>Body extended in Vertical Position with one leg extended forward at a 90° angle to the body</p>		
<b>8 FISHTAIL POSITION</b>		
<p>Body extended in Vertical Position with one leg extended forward. The foot of the forward leg is at the surface of the water regardless of the height of the hips.</p>		
<b>9 TUCK POSITION</b>		
<p>Body as compact as possible, with the back rounded and the legs together. Heels close to buttocks. Head close to knees</p>		
<b>10 FRONT PIKE POSITION</b>		
<p>Body bent at hips to form a 90° angle. Legs extended and together. Trunk extended with the back straight and head in line.</p>		





<b>11 BACK PIKE POSITION</b>		
<p>Body bent at hips to form an acute angle of 45° or less. Legs extended and together. Trunk extended with the back straight and head in line.</p>		
<b>13 SURFACE ARCH POSITION</b>		
<p>Lower back arched with hips, shoulders and head on a vertical line. Legs together and at the surface of the water.</p>		
<b>14 BENT KNEE POSITIONS</b>		
<p>Body in <b>Front Layout, Back Layout, Vertical, or Arched Positions</b>. One leg bent, with the toe of the bent leg in contact with the inside of the extended leg at the knee or higher.</p>		
<p><b>a) Bent Knee Front Layout Position</b></p> <p>Body extended in <b>Front Layout Position</b> with the thigh of the bent leg perpendicular to the surface of the water. Unless otherwise specified face may be in or out of the water.</p>		
<p><b>b) Bent Knee Back Layout Position</b></p> <p>Body extended in <b>Back Layout Position</b>. The thigh of the bent leg is perpendicular to the surface of the water.</p>		
<p><b>c) Bent Knee Vertical Position</b></p> <p>Body extended in <b>Vertical Position</b> with the thigh of the bent leg parallel to the surface of the water.</p>		
<p><b>d) Bent Knee Surface Arch Position</b></p> <p>Lower back arched with hips, shoulders and head on a vertical line. The thigh of the bent leg is perpendicular to the surface of the water</p>		



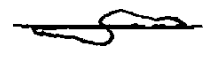

<b>15 TUB POSITION</b>	
<p>Legs bent and together, feet and shins at and parallel to the surface of the water with thighs perpendicular. Head in line with trunk. Face at the surface of the water.</p>	

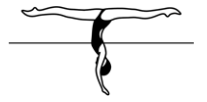
<b>16 SPLIT POSITION</b>	
<p>Legs evenly split forward and back. The legs are parallel to the surface of the water. Lower back arched, with hips, shoulders and head on a vertical line. 180° angle between the extended legs (flat split), with inside of each leg aligned on opposite sides of a horizontal line, regardless of the height of the hips.</p>	
<p><b>a) Surface Split Position</b></p> <p>Legs are dry at the surface of the water.</p>	
<p><b>b) Airborne Split Position</b></p> <p>Legs are above the surface of the water</p>	

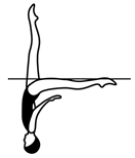
<b>17 KNIGHT POSITION</b>	
<p>Lower back arched, with hips, shoulders and head on a vertical line. One leg vertical. Other leg extended backward with the leg at the surface of the water and as close to horizontal as possible.</p>	

<b>18 KNIGHT VARIANT POSITION</b>	
<p>Lower back arched, with hips, shoulders and head on a vertical line. One leg vertical. The other leg is behind the body with the knee bent at an angle of 90° or less. The thigh and shin of the bent leg are parallel to the surface of the water.</p>	



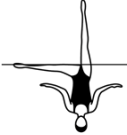

<p><b>19 SIDE FISHTAIL POSITION</b></p>	
<p>Body extended in <b>Vertical Position</b> with one leg extended sideways with the foot at the surface of the water regardless of the height of the hips</p>	

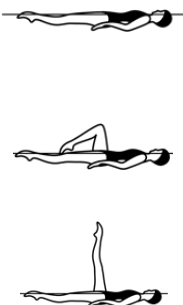
**29.1.2 Basic Movements (BM)**

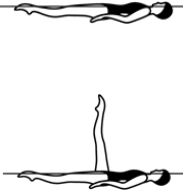

<p><b>1 TO ASSUME A BALLETT LEG / A BALLETT LEG IS ASSUMED</b></p>	
<p>Begin in a <b>Back Layout Position</b>. One leg remains at the surface of the water throughout. The foot of the other leg is drawn along the inside of the extended leg to assume a <b>Bent Knee Back Layout Position</b>. The bent leg is straightened without movement of the thigh to assume a <b>Ballet Leg Position</b>.</p>	

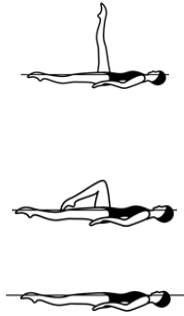
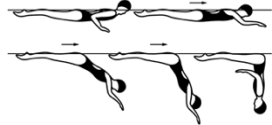
<p><b>1B TO ASSUME A STRAIGHT BALLETT LEG / A STRAIGHT BALLETT LEG IS ASSUMED</b></p>	
<p>From a <b>Back Layout Position</b> one leg is raised straight to a <b>Ballet Leg Position</b>.</p>	



<p><b>2 TO LOWER A BALLETT LEG /THE BALLETT LEG IS LOWERED</b></p>	
<p>From a <b>Ballet Leg Position</b> the ballet leg is bent without movement of the thigh to a <b>Bent Knee Back Layout Position</b>. The toe moves along the inside of the extended leg until a <b>Back Layout Position</b> is assumed.</p>	
<p><b>3 TO ASSUME A FRONT PIKE POSITION / A FRONT PIKE POSITION IS ASSUMED</b></p>	
<p>From a Front Layout Position with the face in the water the trunk moves downward to assume a Front Pike Position. The buttocks, legs and feet travel along the surface of the water until the hips occupy the position of the head at the beginning of this action</p>	
<p><b>4 TO ASSUME A SUBMERGED BALLETT LEG DOUBLE POSITION FROM A FRONT PIKE POSITION/A SUBMERGED BALLETT LEG DOUBLE POSITION IS ASSUMED</b></p>	
<p>While maintaining a <b>Front Pike Position</b> the body somersaults forward around a lateral axis as the buttocks, legs and feet move downward. The hips replace the head to assume a <b>Submerged Ballet Leg Double Position</b>.</p>	
<p><b>5 ARCH TO BACK LAYOUT POSITION</b></p>	
<p>From a <b>Surface Arch Position</b> the hips, chest and face surface sequentially at the same point with foot first movement to a <b>Back Layout Position</b> until the head occupies the position of the hips at the beginning of this action.</p>	

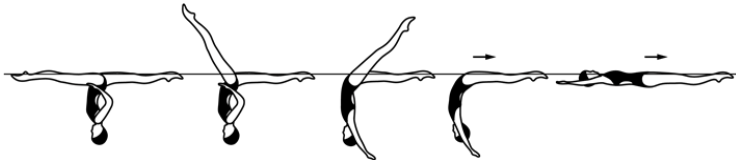

<p><b>6 WALKOUTS</b></p> <p>These movements start in a <b>Split Position</b> unless otherwise specified in the figure description. The hips remain stationary as one leg is lifted in an arc over the surface of the water to meet the opposite leg.</p>	
<p><b>a) Walkout Front</b></p> <p>The front leg is lifted in a 180° arc over the surface of the water to meet the opposite leg in a <b>Surface Arch Position</b> and with continuous movement an <i>Arch to Back Layout Finish Action</i> is executed.</p>	
	
<p><b>b) Walkout Back</b></p> <p>The back leg is lifted in a 180° arc over the surface of the water to meet the opposite leg in a <b>Front Pike Position</b> and with continuous movement the body straightens to a <b>Front Layout Position</b>. The head surfaces at the position occupied by the hips at the beginning of this action.</p>	
	

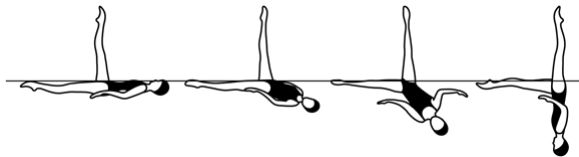
<p><b>7 CATALINA ROTATION</b></p> <p>From a <b>Ballet Leg Position</b> a rotation of the body is initiated. The head, shoulders and trunk begin the rotation at the surface of the water while descending without lateral movement to a <b>Fishtail Position</b>. The vertical leg remains perpendicular to the surface of the water while the foot of the horizontal leg remains at the surface of the water throughout the rotation. Unless otherwise specified, <i>Catalina Rotation</i> starts from a <b>Ballet Leg Position</b>.</p>

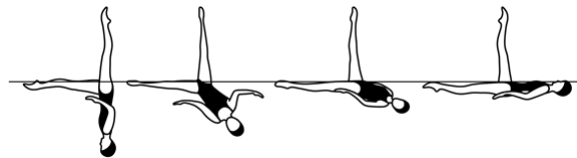

**8 CATALINA REVERSE ROTATION**

From a **Fishtail Position** the hips rotate as the trunk rises without lateral movement to assume a **Ballet Leg Position**. The vertical leg remains perpendicular to the surface of the water while the foot of the horizontal leg remains at the surface of the water throughout the rotation.

**9 THRUST**

From a Submerged Back Pike Position with the legs perpendicular to the surface of the water a vertical upward movement of the legs and hips is rapidly executed as the body unrolls to assume a Vertical Position. Maximum height desirable.

**THRUST ALLOWANCE**

Deviation allowances for the Thrust action are unique and allow for the legs to be up to an additional 15 degrees off the vertical line.

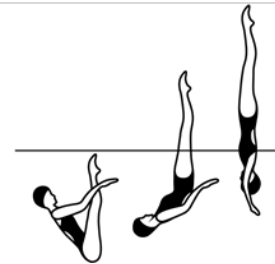

Deductions are as follows:

	<b>Angle Deviation</b>	<b>Deduction Amount</b>	
Small Deviation	16 – 30 degrees	0.2	
Medium Deviation	31 – 45 degrees	0.5	
Large Deviation	More than 45 degrees	1.0	

**10 VERTICAL DESCENT**

Maintaining a **Vertical Position** the body descends along its longitudinal axis until the toes are submerged.



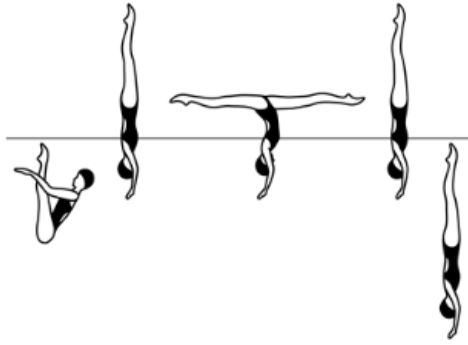

**11 ROCKET SPLIT**

A *Thrust* is executed to a **Vertical Position**. Maintaining maximum height the legs are split simultaneously and rapidly to assume an **Airborne Split Position** and rejoin to a **Vertical Position**, followed by a *Vertical Descent*. The *Vertical Descent* is executed at the same tempo as the *Thrust*.

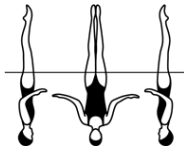

**12 TWISTS**

A *Twist* is a rotation at a sustained height. The body remains on its longitudinal axis throughout the rotation. Unless otherwise specified when performed in a **Vertical Position** a *Twist* is completed with a *Vertical Descent*.

**a) Half Twist:**  
a *Twist* of 180°

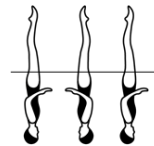

**b) Full Twist:**  
a *Twist* of 360°



**c) A Twirl:**  
a rapid *Twist* of 180°

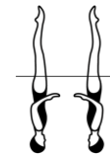



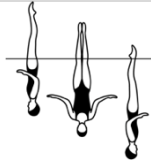
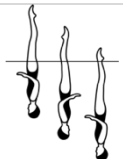
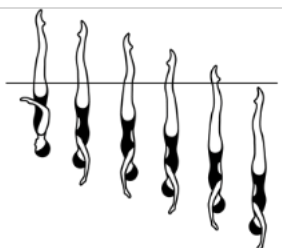
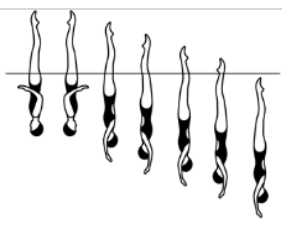

**Twist Allowance**

The acceptable allowance for *Twist* rotations (*Half Twist*, *Full Twist* and *Twirl*) is up to ¼ less than/more than the required rotation.

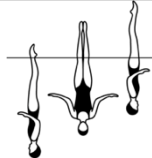

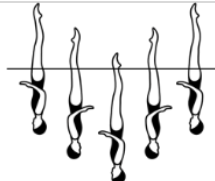
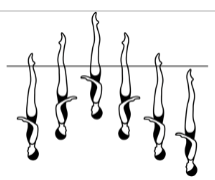
<p><b>13 SPINS</b></p> <p>A <i>Spin</i> is a rotation in a <b>Vertical Position</b>. The body remains on its longitudinal axis throughout the rotation. Unless otherwise specified <i>Spins</i> are executed in uniform motion and are completed with a <i>Vertical Descent</i> executed at the same tempo as the <i>Spin</i>.</p> <p>A <i>descending Spin</i> must start at the height of the vertical and be completed as the ankle(s) reach(es) the surface of the water. Unless otherwise specified a <i>descending Spin</i> is completed with a <i>Vertical Descent</i> which is executed at the same tempo as the <i>Spin</i>.</p>	
<p><b>d) 180° Spin/Spinning 180°:</b> a descending Spin with a rotation of 180°</p>	
<p><b>e) 360° Spin/Spinning 360°:</b> a descending Spin with a rotation of 360°.</p>	
<p><b>f) Continuous Spin:</b> a descending Spin with a rapid rotation of: 720° (2), 1080° (3), or 1440° (4) which is completed as the ankles reach the surface of the water and continues through submergence. Continuous Spin 720° shown →</p>	
<p><b>g) Twist Spin:</b> a Half Twist is executed and without a pause is followed by a Continuous Spin of 720° (2) performed in the same direction as the <i>Half Twist</i>.</p>	



<b>13 SPINS (cont.)</b>	
<p>An <i>ascending Spin</i> begins with the water level at the ankles unless otherwise specified. A vertical upward <i>Spin</i> is executed until a water level is established between the knees and hips. An <i>ascending Spin</i> is finished with a <i>Vertical Descent</i>.</p>	
<p><b>h) Spin Up 180°:</b> an ascending Spin with a rotation of 180°</p>	
<p><b>i) Spin Up 360°:</b> an ascending Spin with a rotation of 360°.</p>	
<p><b>j) Combined Spin:</b> a <i>descending Spin</i> of at least 360° followed without a pause by an equal <i>ascending Spin</i> in the same direction. The <i>ascending Spin</i> reaches the same height where the <i>descending Spin</i> started.</p>	
<p><b>k) Reverse Combined Spin:</b> an <i>ascending Spin</i> of at least 360° followed without a pause by an equal <i>descending Spin</i> in the same direction.</p>	
<p><b>l) Bent Knee Combined Spin:</b> a <i>descending Spin</i> in a Bent Knee Vertical Position of at least 360° followed without a pause by an equal <i>ascending Spin</i> in the same direction in a Bent Knee Vertical Position. The <i>ascending Spin</i> reaches the same height where the <i>descending Spin</i> started.</p>	
<p><b>m) Reverse Bent Knee Combined Spin:</b> an <i>ascending Spin</i> in a Bent Knee Vertical Position of at least 360° followed without a pause by an equal <i>descending Spin</i> in the same direction in a Bent Knee Vertical Position.</p>	





**Spin Allowance**

The acceptable allowance for a *Continuous Spin* is up to 180° less than/more than the required rotation.

The acceptable allowance for other *Spins* (180° Spin, 360° Spin, 720° Spin, Twist Spin, Spin Up 180°, Spin Up 360°) is up to ¼ less than/more than the required rotation. There is no Spin allowance for Combined Spin.

**14. TO ASSUME A SURFACE ARCH POSITION / A SURFACE ARCH POSITION IS ASSUMED**

From a **Back Layout Position** with the head leading, the head, hips and feet move along the surface of the water. With continuous movement the head leaves the surface of the water as the back is arched more to assume a **Surface Arch Position** with the hips occupying the position of the head at the beginning of this action

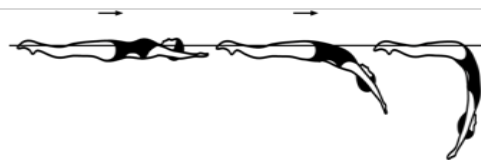

**15 TO ASSUME A BENT KNEE SURFACE ARCH POSITION / A BENT KNEE SURFACE ARCH POSITION IS ASSUMED**

From a **Back Layout Position** with the head leading, the head, hips and feet move along the surface of the water. With continuous movement the head leaves the surface of the water as the back is arched more to assume a **Bent Knee Surface Arch Position** with the hips occupying the position of the head at the beginning of this action

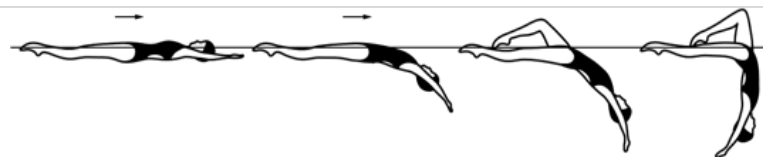



**16 ARIANA ROTATION**

From a **Split Position** maintaining the relative position of the legs to the surface of the water the hips rotate 180°.



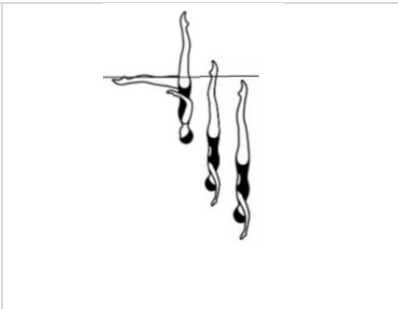
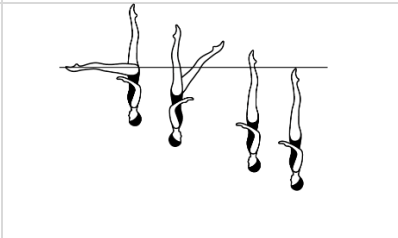
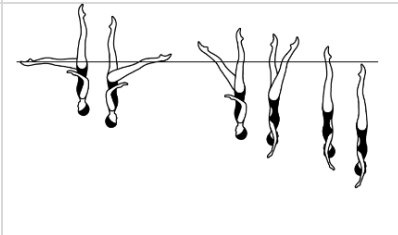
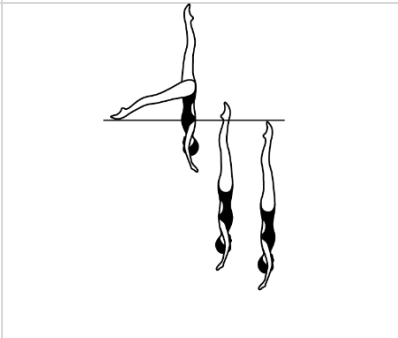

<b>17 HELICOPTER ROTATION</b>	
<p>From a Fishtail Position the horizontal leg is lifted while closing into the vertical leg to assume a Vertical Position during a descending rotation and is completed as the ankles reach the surface of the water</p>	
<p><b>a) Spinning 180°:</b> A descending Spin with a rotation of 180° completed with a Vertical Descent.</p>	
<p><b>b) Spinning 360°:</b> A descending Spin with a rotation of 360° completed with a Vertical Descent.</p>	
<p><b>c) Continuous Spin 720°:</b> A descending Spin with a rapid rotation of: 720° (2), completed as the ankles reach the surface of the water and continues through submergence.</p>	
<p><b>d) Rapid Airborne Spinning 180°:</b> From an airborne <b>Fishtail Position</b> the horizontal leg is rapidly lifted while closing into the vertical leg to <b>Vertical Position</b> during a rapid descending Spin with a rotation of 180° and is completed as the ankles reach the surface of the water followed by a rapid Vertical Descent.</p>	
<b>18 FOUETTÉ ROTATION</b>	
<p>From a <b>Fishtail Position</b> with the horizontal leg leading toward the vertical leg a rapid 180° rotation is executed as the front leg bends to assume a <b>Bent Knee Vertical Position</b>. The bent leg rapidly extends to a Fishtail Position.</p>	
	





**29.1.3 12 and under Figures**

Group & Figure #	Figure Name	DD
<b>Compulsory</b>		
106	Straight Ballet Leg	1.6
301	Barracuda	1.8
<b>Optional Groups</b>		
<b>Group 1</b>		
359	Front Ariana	2.2
348	Tower	1.9
<b>Group 2</b>		
363	Water Drop	1.8
401	Swordfish	2.1
<b>Group 3</b>		
311	Kip	1.6
227d	Swanita Spinning 180°	1.9

**29.1.3.1 Compulsory:**
**106 – Straight Ballet leg / DD-1.6**

From a **Back Layout Position**, one leg is raised straight to a **Ballet Leg Position**. The Ballet Leg is lowered.





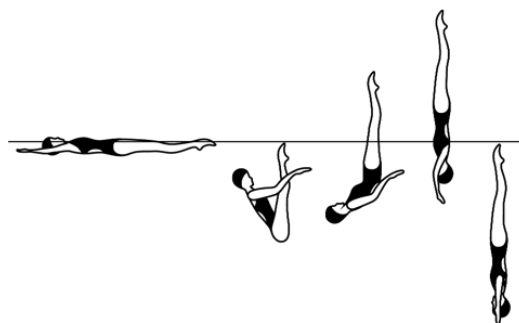

				<b>Total</b>
<b>NVT=</b>	18.5	11.0	10.5	<b>40</b>
<b>PV =</b>	4.63	2.75	2.63	<b>10</b>

**301 – Barracuda / DD - 1.8**

From a **Back Layout Position** the legs are raised to vertical as the body is submerged to a **Back Pike Position** with the toes just under the surface of the water. A *Thrust* is executed to a **Vertical Position**. A *Vertical Descent* is executed at the same tempo as the *Thrust*.











				<b>Total</b>	
<b>NVT=</b>	7.0	31.0	13.0		<b>51</b>
<b>PV =</b>	1.37	6.08	2.55		<b>10</b>

**29.1.3.2 Optional Groups**
**29.1.3.2.1 Group 1**
**359 – Front Ariana / DD - 2.2**

From a **Front Layout Position** a *Front Pike Position* is assumed. One leg is lifted in a 180° arc over the surface of the water to a **Split Position**. Maintaining the relative position of the legs to the surface of the water, an *Ariana Rotation* is performed. A *Walkout Front* is executed.





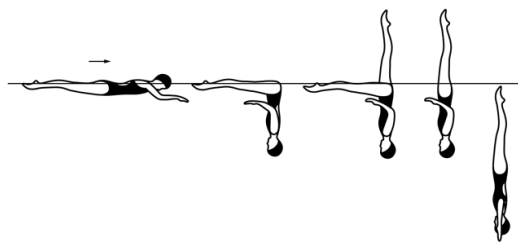

						<b>Total</b>	
<b>NVT=</b>	6.0	20.0	17.0	23.0	7.0		<b>73</b>
<b>PV =</b>	0.82	2.74	2.33	3.15	0.96		<b>10</b>

**348 – Tower / DD - 1.9**

From a **Front Layout Position** a *Front Pike Position* is assumed. One leg is lifted to a **Fishtail Position**. The horizontal leg is lifted to a **Vertical Position**. A Vertical Descent is executed.

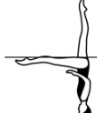





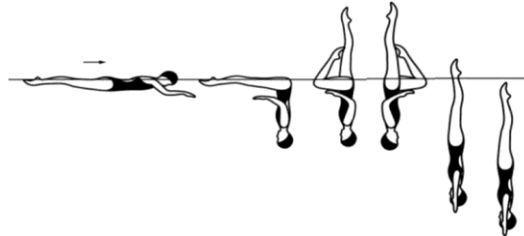

					<b>Total</b>	
<b>NVT=</b>	6.0	14.5	20.5	14.0		<b>55</b>
<b>PV =</b>	1.09	2.64	3.73	2.55		<b>10</b>

**29.1.3.2.2 Group 2**
**363 – Water Drop / DD - 1.8**

From a **Front Layout Position** a *Front Pike Position* is assumed. The legs are lifted simultaneously to a **Bent Knee Vertical Position**. A *Half Twist* is executed. A *180° Spin* is executed in the same direction as the bent leg is extended to a **Vertical Position** and completed as the ankles reach the surface of the water. A *Vertical Descent* is executed.





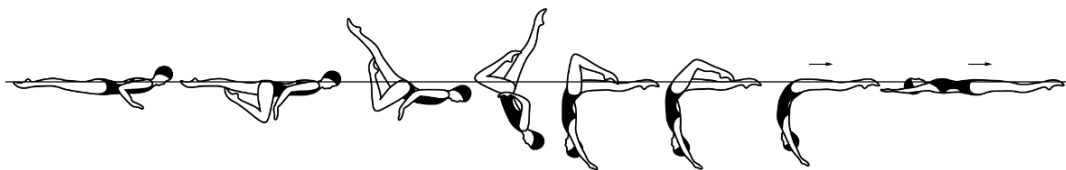

						<b>Total</b>
<b>NVT=</b>	6.0	15.0	15.0	13.0	0	
<b>PV =</b>	1.22	3.06	3.06	2.65	0	<b>10</b>

**401 – Swordfish / DD - 2.1**

From a **Front Layout Position** a **Bent Knee Front Layout Position** is assumed. The back arches more as the extended leg is lifted in a *180° arc* over the surface of the water to assume a **Bent Knee Surface Arch Position**. The bent leg is straightened to assume a **Surface Arch Position**. With continuous motion an *Arch to Back Layout Finish Position* is executed.





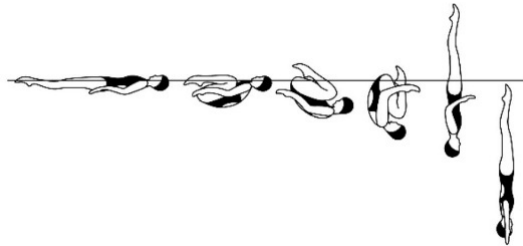

					<b>Total</b>
<b>NVT=</b>	4.0	47.0	11.5	7.0	
<b>PV =</b>	0.58	6.76	1.65	1.01	<b>10</b>

**29.1.3.2.3 Group 3**
**311 – Kip / DD - 1.6**

From a **Back Layout Position** the knees, shins and toes are drawn along the surface of the water to assume a **Tuck Position**. With continuous motion the tuck becomes more compact and a partial Somersault Back Tuck is executed until the shins are perpendicular to the surface of the water. The trunk unrolls as the legs are straightened to assume a **Vertical Position** midway between the former vertical line through the hips and the former vertical line through the head and shins. A *Vertical Descent* is executed.







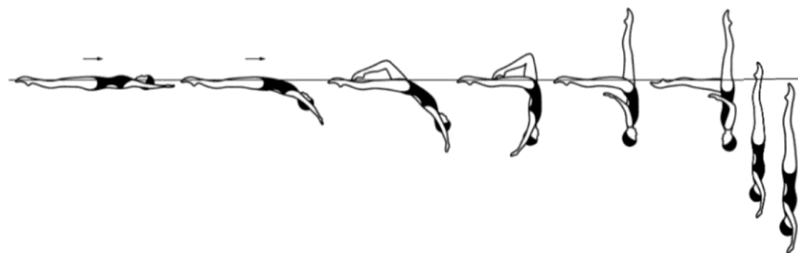

					<b>Total</b>
<b>NVT=</b>	3.0	2.0	23.0	14.0	<b>42</b>
<b>PV =</b>	0.71	0.48	5.48	3.33	<b>10</b>

**227d – Swanita Spinning 180° / DD - 1.9**

From a **Back Layout Position** a *Bent Knee Surface Arch Position* is assumed. The bent leg is straightened to assume a **Knight Position**. The body rotates 180° to assume a **Fishtail Position**. Continuing in the same direction a descending *Spinning 180°* rotation is executed as the horizontal leg is lifted to a **Vertical Position** and is completed as the ankles reach the surface of the water. A *Vertical Descent* is executed.









						<b>Total</b>
<b>NVT=</b>	17.5	14.0	14.0	12.5	0	<b>58</b>
<b>PV =</b>	3.02	2.41	2.41	2.16	0	<b>10</b>

**29.1.4 Youth Figures / 13-15 Figures**

Group & Figure #	Figure Name	DD
<b>Section A</b>		
<b>Group 1</b>		
307e	Flying Fish Spinning 360°	2.9
437	Cyclone, Open 180°	2.6
<b>Group 2</b>		
308h	Barracuda Airborne Split Spin Up 180°	2.9
407	Swordfish Straight Leg Ariana Rotation	2.6
<b>Section B</b>		
<b>Group 3</b>		
356f	Whip Continuous Spin 720°	3.0
441	Saturn	2.5
<b>Group 4</b>		
352	Venus	3.0
240i	Albatross Spin up 360°	2.5
<b>Section C</b>		
<b>Group 5</b>		
140j	Flamingo Bent Knee Combined Spin 360° + 360°	3.1
421	Walkover Back Closing 360°	2.4
<b>Group 6</b>		
440d	Ipanema Spinning 180°	3.1
154f	London Continuous Spin 720°	2.4

**29.1.4.1 Section A**
**29.1.4.1.1 Group 1**
**307e - Flying Fish Spinning 360° / DD - 2.9**





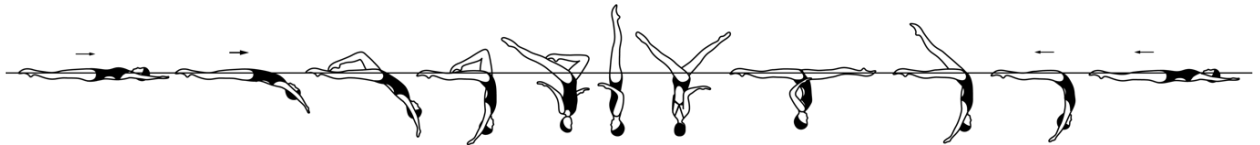

From a **Back Layout Position** the legs are raised to vertical as the body is submerged to a **Back Piked Position**, with the toes just below the surface of the water. A *Thrust* is executed to a **Vertical Position** and without loss of height one leg is rapidly lowered to a **Fishtail Position**, and without a pause the horizontal leg is rapidly lifted to a **Vertical Position**. A *Spinning 360°* is executed at the same tempo as the *Thrust*.

							Total	
NVT =	7.0	31.0	18.5	14.0	39.0	0		109.5
PV=	0.64	2.83	1.69	1.28	3.56	0		10

**437 – Cyclone, Open 180° / DD - 2.6**

From a **Back Layout Position** a *Bent Knee Surface Arch Position* is assumed. The legs are simultaneously lifted to a **Vertical Position** as a *Twirl* is executed. Continuing in the same direction the legs are opened symmetrically to a **Split Position** as a 180° rotation is executed. A *Walkout Front* is executed.









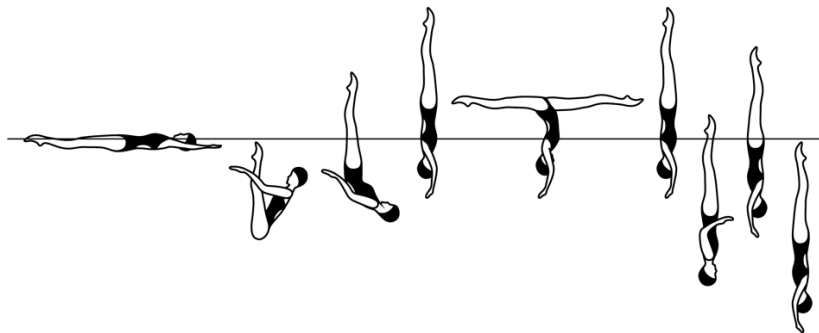

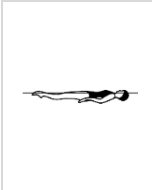
						<b>Total</b>
<b>NVT=</b>	17.5	29.0	20.0	23.0	7.0	<b>96.5</b>
<b>PV =</b>	1.81	3.01	2.07	2.38	0.73	<b>10</b>

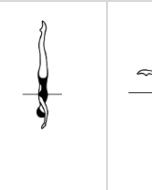
**29.1.4.1.2 Group 2**
**308h – Barracuda Airborne Split, Spin Up 180° / DD - 2.9**

From a **Back Layout Position** the legs are raised to a vertical as the body is submerged to a **Back Pike Position** with the toes just under the surface of the water. All remaining movements are performed rapidly. A *Rocket Split* is executed. A *Vertical Descent* is executed and is completed as the ankles reach the surface of the water. A *Spin Up 180°* is executed. A *Vertical Descent* is executed.









								<b>Total</b>
<b>NVT=</b>	7.0	31.0	17.0	13.0	13.0	20.0	13.0	<b>114</b>
<b>PV =</b>	0.61	2.72	1.49	1.14	1.14	1.75	1.14	<b>10</b>

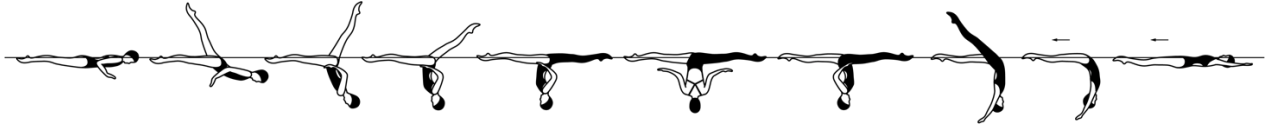

**407 – Swordfish Straight Leg Ariana Rotation / DD - 2.6**

From a **Front Layout Position** the back arches as one leg is lifted in a 180° arc over the surface of the water to a **Split Position**. Maintaining the relative position of the legs to the surface of the water an *Ariana Rotation* is performed. A *Walkout Front* is executed.







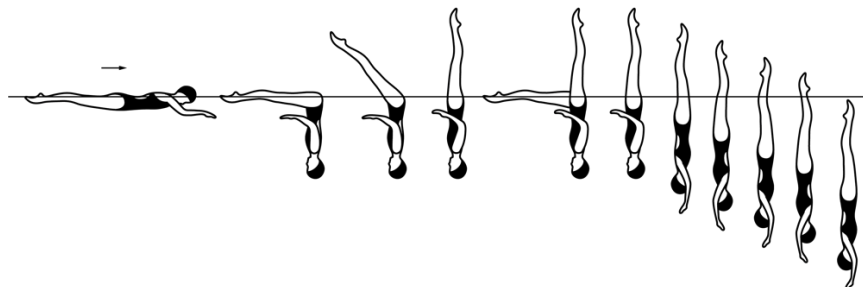

					<b>Total</b>
<b>NVT=</b>	48.0	17.0	23.0	7.0	<b>95</b>
<b>PV =</b>	5.05	1.79	2.42	0.74	<b>10</b>

**29.1.4.2 Section B**
**29.1.4.2.1 Group 3**
**356f - Whip Continuous Spin 720° DD - 3.0**

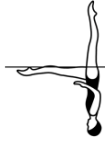
From a **Front Layout Position** a *Front Pike Position* is assumed. The legs are lifted to a **Vertical Position**. All remaining movements are performed rapidly. One leg is lowered to a **Fishtail Position** and without a pause is lifted to a **Vertical Position**. Without a pause a *Continuous Spin 720°* is executed.





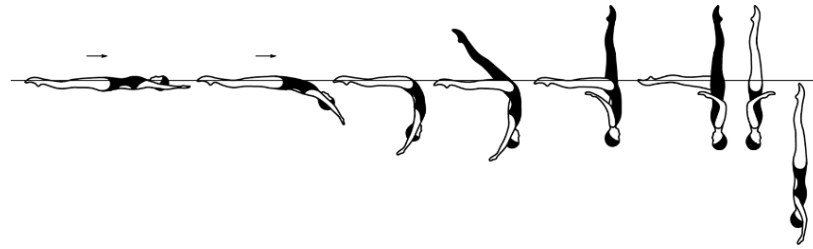

							<b>Total</b>
<b>NVT=</b>	6.0	33.0	22.5	20.5	34.0	0	<b>116</b>
<b>PV =</b>	0.52	2.84	1.94	1.77	2.93	0	<b>10</b>

**441 – Saturn / DD - 2.5**

From a **Back Layout Position** a *Surface Arch Position* is assumed. One leg is lifted to assume a **Knight Position**. Maintaining the vertical alignment, the body rotates 180° to assume a **Fishtail Position**. Continuing in the same direction a *Twirl* is executed as the horizontal leg is lifted to a **Vertical Position**. A *Vertical Descent* is executed.



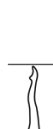





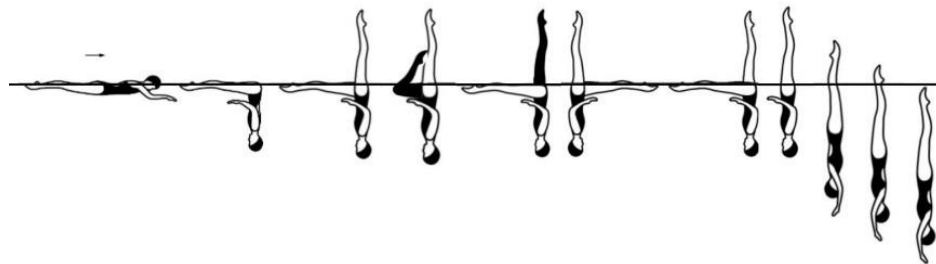

						<b>Total</b>
<b>NVT=</b>	12.0	23.5	14.0	23.5	14.0	<b>87</b>
<b>PV =</b>	1.38	2.70	1.61	2.70	1.61	<b>10</b>

**29.1.4.2.2 Group 4**
**352 – Venus / DD - 3.0**

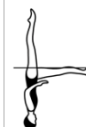
From a **Front Layout Position** a *Front Pike Position* is assumed. All remaining movements are performed rapidly. One leg is lifted to a **Fishtail Position**. The horizontal leg is bent to assume a **Bent Knee Vertical Position**. The bent leg is extended to vertical as the vertical leg is lowered to become the horizontal leg in **Fishtail Position**. A rotation of 360° is executed in the **Fishtail Position**. The horizontal leg is lifted to a **Vertical Position**. A 360° *Spin* is executed.

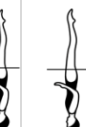







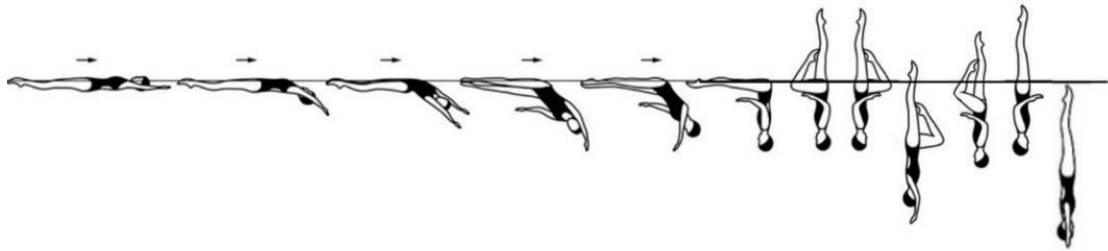

										<b>Total</b>
<b>NVT=</b>	6.0	12.5	12.5	18.5	24.0	20.5	23.0	0	<b>117</b>	
<b>PV =</b>	0.51	1.07	1.07	1.58	2.05	1.75	1.97	0	<b>10</b>	

**240i – Albatross Spin Up 360° / DD - 2.5**











From a **Back Layout Position** with the head leading, the head, hips and feet move along the surface of the water. The hips, legs and feet continue to move along the surface of the water as the body rolls onto the face and a *Front Pike Position* is assumed with the hips occupying the position of the head at the beginning of this action. The legs are lifted simultaneously to a **Bent Knee Vertical Position**. A *Half Twist* is executed. Maintaining a **Bent Knee Vertical Position**, a *Vertical Descent* is executed until the ankle of the extended leg reaches the surface of the water. A *Spin Up 360°* is executed as the bent leg is extended to **Vertical Position**. A *Vertical Descent* is executed.



							<b>Total</b>
<b>NVT=</b>	15.0	15.0	15.0	10.0	18.5	14.0	<b>87.5</b>
<b>PV =</b>	1.71	1.71	1.71	1.14	2.11	1.60	<b>10</b>

**29.1.4.3 Section C**
**29.1.4.3.1 Group 5**
**140j – Flamingo Bent Knee Combined Spin 360° + 360° / DD - 3.1**





A *Ballet Leg* is assumed. The shin of the horizontal leg is drawn along the surface of the water to assume a **Surface Flamingo Position**. With the ballet leg maintaining its vertical position, the hips are lifted as the trunk unrolls while the bent leg moves to a **Vertical Bent Knee Position**. The bent leg is extended to **Vertical Position**. A rapid *Combined Spin* (360°+360°) is executed followed by a rapid *Vertical Descent*.

								<b>Total</b>
<b>NVT=</b>	10.5	11.0	7.5	20.0	16.5	40.0	14.0	119.5
<b>PV =</b>	0.88	0.92	0.63	1.67	1.38	3.35	1.17	10

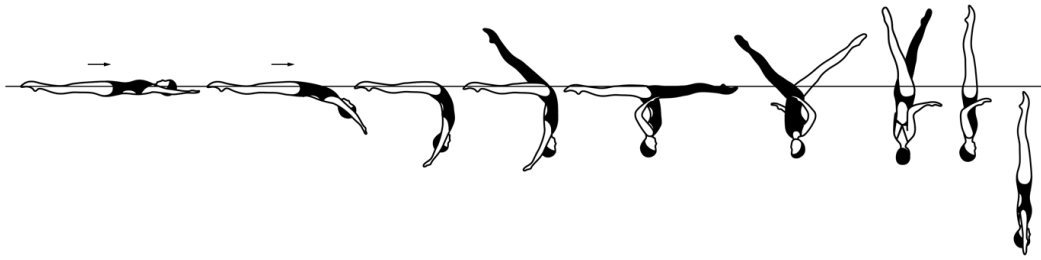
**421 – Walkover Back Closing 360° / DD 2.4**

From a **Back Layout Position** a *Surface Arch Position* is assumed. One leg is lifted in a 180° arc over the surface of the water to a **Split Position**. With continuous motion a rotation of 360° is executed as the legs are symmetrically lifted and closed to a **Vertical Position**. A *Vertical Descent* is executed.







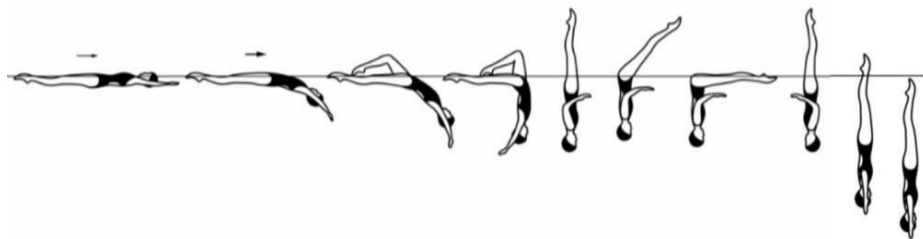

					<b>Total</b>
<b>NVT=</b>	12.0	29.0	27.0	14.0	
<b>PV =</b>	1.46	3.54	3.29	1.71	<b>10</b>

**29.1.4.3.2 Group 6**
**440d – Ipanema Spinning 180° / DD - 3.1**

From a **Back Layout Position** a *Bent Knee Surface Arch Position* is assumed. The horizontal leg is lifted to vertical as the bent leg is straightened to assume a **Vertical Position**. The legs are lowered to a **Front Pike Position**. A rapid 180° rotation is executed as the legs are lifted to a **Vertical Position**. Continuing in the same direction a rapid 180° *Spin* is executed.









							<b>Total</b>
<b>NVT=</b>	17.5	21.0	33.0	33.0	16.0	0	
<b>PV =</b>	1.42	1.70	2.67	2.67	1.54	0	<b>10</b>

**154f – London Continuous Spin 720° / DD - 2.4**



A *Ballet Leg* is assumed. Followed by a partial Somersault Back Tuck as both legs are drawn into a Tuck Position, until the shins are perpendicular to the surface. The trunk unrolls rapidly as the legs are rapidly straightened to assume a **Vertical Position** midway between the former vertical line through the hips and the former vertical line through the head and the shins. A *Continuous Spin 720°* is executed.

						Total
NVT	10.5	11.0	6.0	20.0	34.0	81.5
PV	1.29	1.35	0.74	2.45	4.17	10

**29.2 Appendix 2 - Technical Routines**
**Technical Required Elements**

Solo Elements	Element Name	DD
1a	Thrust Continuous Spin 720°	2.7
1b	Thrust Spinning 360°	2.1
2a	Combined Spin 1080° – Continuous Spin 1080°	3.0
2b	Combined Spin 720° – Continuous Spin 1080°	2.7
3	Swordfish Straight Leg – Knight	3.2
4a	Fishtail Half Twist – Continuous Spin 720°	2.9
4b	Fishtail – Continuous Spin 720°	2.6
5a	Rocket Split Bent Knee Joining 360°	2.4
5b	Rocket Split Bent Knee	2.1

Duet Elements	Element Name	DD
1a	Walkover Back Closing 360° – Continuous Spin 1080°	3.0
1b	Walkover Back Closing 180° – Continuous Spin 720°	2.5
2a	Rocket Split Alternating Legs – Spinning 180°	2.8
2b	Rocket Split – Spinning 180°	2.4
3	Beginning from a Ballet Leg Position – Flamingo Bent Knee rollback – Join to VP – Half Twist – 360° open to Split – Walkout	3.1
4a	Fishtail – Knight – Continuous Spin 1080°	3.2
4b	Fishtail – Knight – Continuous Spin 720°	2.7
5a	Thrust Bent Knee Twirl Spin 360°	2.3
5b	Thrust – Bent Knee Twirl	2.1

Mixed Duet Elements	Element Name	DD
1a	Rocket Split Twirl Spin 180°	2.7
1b	Rocket Split Twirl	2.5
2a	Front Pike – Vertical 360° Rotation – Full Twist to Bent Knee – Continuous Spin 720°	2.4
2b	Front Pike – Vertical 180° Rotation – 1/2 Twist to Bent Knee – Continuous Spin 720°	2.2
3	Manta Ray Half Twist	3.0

Team Elements	Element Name	DD
1a	Flying Fish Hybrid Spinning 180°	2.5
1b	Flying Fish Hybrid	2.3
2a	Vertical – Full Twist to Bent Knee – Full Twist to Vertical – Open 180° – Walkout	2.6
2b	Vertical – Half Twist to Bent Knee – Half Twist to Vertical – Split – Walkout	2.3
3a	Two Fouetté Rotations – Vertical – Continuous Spin 720°	2.6
3b	Two Fouetté Rotations – Vertical – Spinning 360°	2.3
4	Butterfly Hybrid	2.9
5a	Rocket Split Bent Knee Twirl Hybrid	2.4
5b	Rocket Split Bent Knee Hybrid	2.1

**29.2.1 General Requirements**

In Olympic Games, Olympic Games Qualifier, Artistic Swimming World Cup, World Aquatics Artistic Swimming Championships and World Aquatics Junior Artistic Swimming Championships and other World Aquatics competitions as designated, Required Elements are used.

- 1) Unless otherwise specified in the description all required elements must be executed according to the requirements described in the World Aquatics AS Manual for Judges, Coaches and Referees.
- 2) If 1 or more competitors omits all or part of an element or performs an incorrect action in an element, refer to 2022-2025 World Aquatics Competition Regulations for penalties regarding incorrect or omitted actions.
- 3) Required Elements #1 - #5 (Solo, Duet and Team), or #1-3 (Mixed Duet) can be performed in any order.
- 4) Required Elements #1 - #5 (Solo, Duet and Team), or #1-3 (Mixed Duet) - It is required that the elements and the degrees of difficulty for each element selected to be performed, and the order of performance selected, must be declared and submitted on the Coach Card for the Technical Routine. This form must be submitted prior to the Competition/Event.
- 5) Additional hybrids and the degrees of difficulty for each hybrid selected, and the order to be performed, must be declared and submitted on the Coach Card for the Technical Routine. This form must be submitted prior to the Competition/Event.
- 6) For Team and Women's Duet: With the exception of Deck Work and Entry into the water, getting into and out of the Circle (Team), and Acrobatics, Technical Required Elements, Free Hybrids and Transitions are to be performed simultaneously and facing the same direction by all duet or team members.
- 7) For Mixed Duets: Only Technical Required Elements must be performed simultaneously and facing the same direction. Deckwork and Entry into the water, Free Hybrid, Required Hybrid, Entry into or Exit out of Technical Required Elements, Transitions and Pair Acrobatics DO NOT have this restriction and MAY be performed freely (non-simultaneous and facing different directions).
- 8) Additional movements can be added immediately before and after (breath to breath) Required Elements #1 - #5 (Solo, Duet and Team), or #1-3 (Mixed Duet). These movements will not add any extra difficulty nor will be considered as the additional hybrids.
- 9) Time limits – refer to Part Seven - 14
- 10) Recommendation for all Technical Routines:

It is strongly recommended for clarity of judgment that Required Elements #1 - #5 (Solo, Duet and Team), or #1-3 (Mixed Duet) are separated by other content.

**29.2.2 Solo Required Elements**
**Element 1**
**1A – Thrust Continuous Spin 720° / DD - 2.7**

From a **Submerged Back Pike Position**, with the legs perpendicular to the surface, a *Thrust Continuous Spin 720°* (2 rotations) is executed.

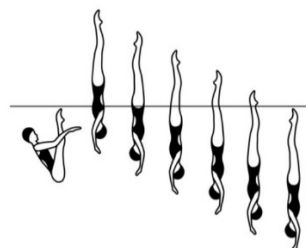

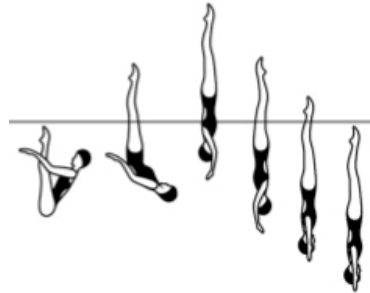

**1B – Thrust Spinning 360° / DD - 2.1**

From a **Submerged Back Pike Position**, with the legs perpendicular to the surface, a *Thrust Spinning 360°* (1 rotation) is executed.

**Element 2**

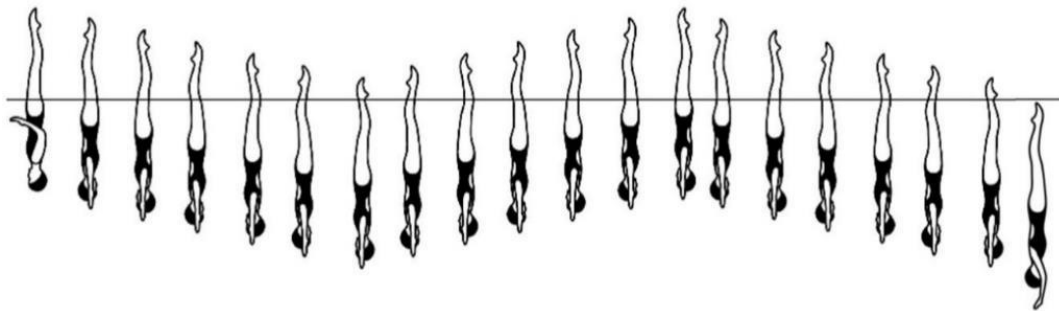
**2A – Combined Spin 1080° – Continuous Spin 1080° / DD - 3.0**

From a **Vertical Position** a *Combined Spin of 1080°* is executed (3 rotations + 3 rotations). Continuing in the same direction and without a pause a *Continuous Spin 1080°* (3 rotations) is executed.

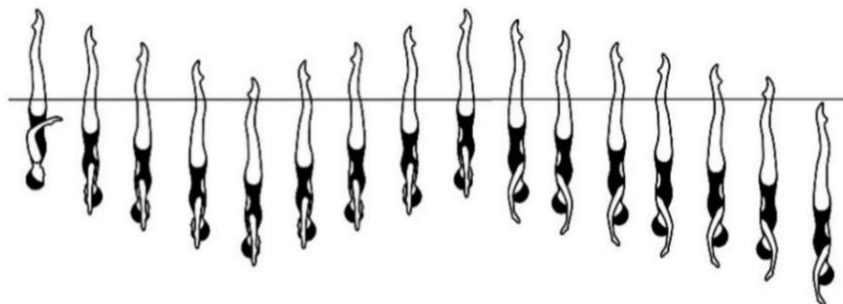

**2B – Combined Spin 720° – Continuous Spin 1080° / DD - 2.7**

From a **Vertical Position** a *Combined Spin of 720°* is executed (2 rotations + 2 rotations). Continuing in the same direction and without a pause a *Continuous Spin 1080°* (3 rotations) is executed.

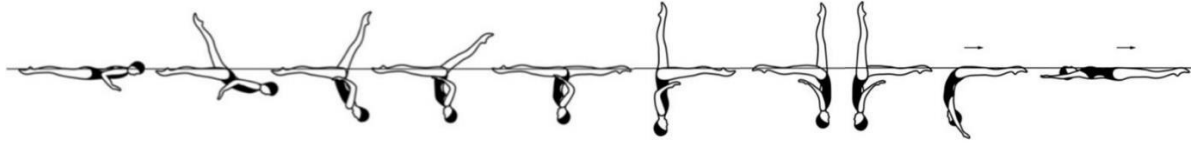

**Element 3**
**3 – Swordfish Straight Leg – Knight / DD - 3.2**

From a **Front Layout Position**, the back arches as one leg is lifted in a 180° arc over the surface to a **Split Position**. A hip rotation of 180° is executed as the front leg is rapidly raised to assume a **Fishtail Position**. Maintaining the vertical alignment of the body and with accelerating speed, the foot of the horizontal leg is moved in a horizontal arc of 180° at the surface to a **Knight Position** and with continuous motion and continuing in the same direction an additional 180° rotation is executed. The vertical leg is lowered to a **Surface Arch Position** and with continuous motion an Arch to *Back Layout Finish Action* is executed.



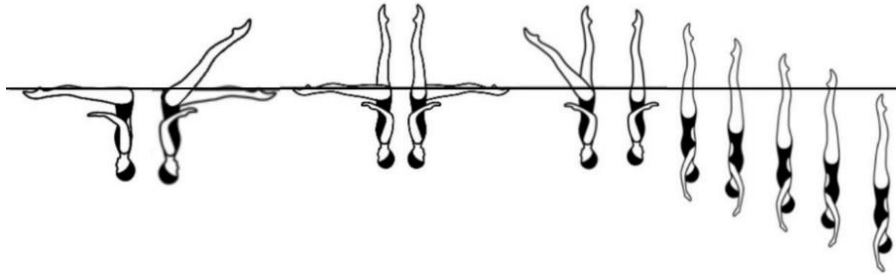

**Element 4**
**4A – Fishtail Half Twist – Continuous Spin 720° / DD – 2.9**

From a **Front Pike Position**, a rotation of 360° is executed as one leg is lifted to a **Fishtail Position**. Continuing in the same direction a *Half Twist* in a **Fishtail Position** is executed. Continuing in the same direction another rotation of 360° is executed, as the horizontal leg is lifted to a **Vertical Position**. Continuing in the same direction, a *Continuous Spin of 720°* (2 rotations) is executed.

**4B – Fishtail – Continuous Spin 720° / DD – 2.6**

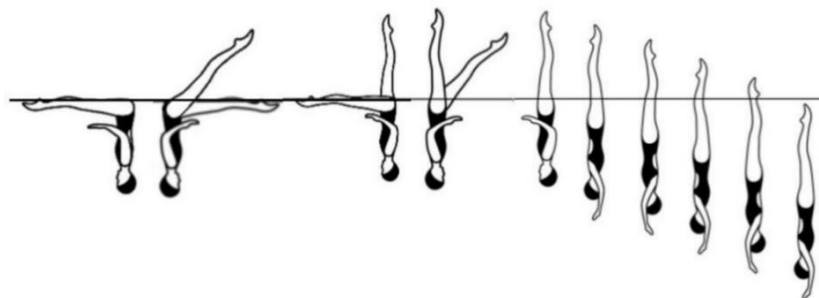
From a **Front Pike Position**, a rotation of 360° is executed as one leg is lifted to a **Fishtail Position**. Continuing in the same direction another rotation of 360° is executed, as the horizontal leg is lifted to a **Vertical Position**. Continuing in the same direction a *Continuous Spin of 720°* (2 rotations) is executed.

**Element 5**
**5A – Rocket Split Bent Knee Joining 360° / DD - 2.4**

From a **Submerged Back Pike Position**, with the legs perpendicular to the surface, a *Thrust* is executed to a **Vertical Position**. Maintaining maximum height, the legs are split rapidly to assume an **Airborne Split Position**. The back leg is rapidly lifted to vertical and the front leg bends to assume a **Bent Knee Vertical Position**. A rapid *360° Spin* is executed as the bent knee is extended to a **Vertical Position** completed as the ankles reach the surface of the water followed by a *Vertical Descent* at the same tempo as the *Thrust*.

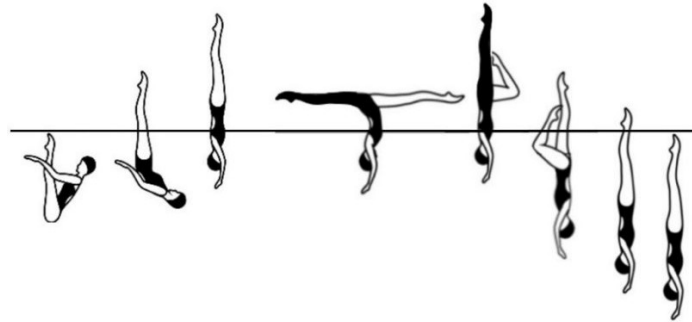
**5B – Rocket Split Bent Knee / DD - 2.1**

From a **Submerged Back Pike Position**, with the legs perpendicular to the surface, a *Thrust* is executed to a **Vertical Position**. Maintaining maximum height, the legs are split rapidly to assume an **Airborne Split Position**. The back leg is rapidly lifted to vertical and the forward leg bends to assume a **Bent Knee Vertical Position**. A *Vertical Descent* is executed with the bent knee extended to a **Vertical Position** completed as the ankles reach the surface of the water, followed by a *Vertical Descent* at the same tempo as the *Thrust*.

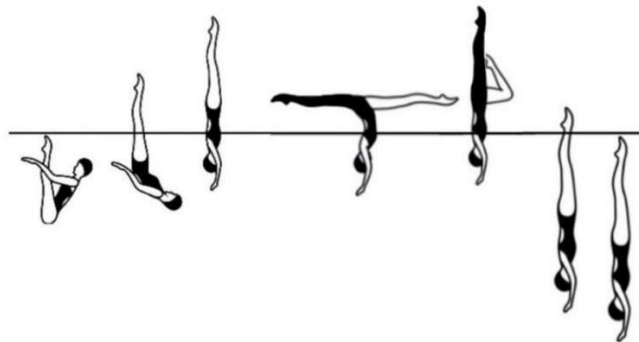
**Solo Technical Routine Additional Requirements**

**6** – One (1) additional hybrid must be performed. It may be placed anywhere in the routine.

**29.2.3**
**Duet Required Elements**
**Element 1**
**1A – Walkover Back Closing 360° – Continuous Spin 1080° / DD - 3.0**

From a **Back Layout Position** a *Surface Arch Position* is assumed. One leg is lifted in a 180° arc over the surface to a **Split Position**. A rotation of 360° is executed, as the legs symmetrically close to a **Vertical Position**. Continuing in the same direction a *Continuous Spin of 1080°* (3 rotations) is executed.

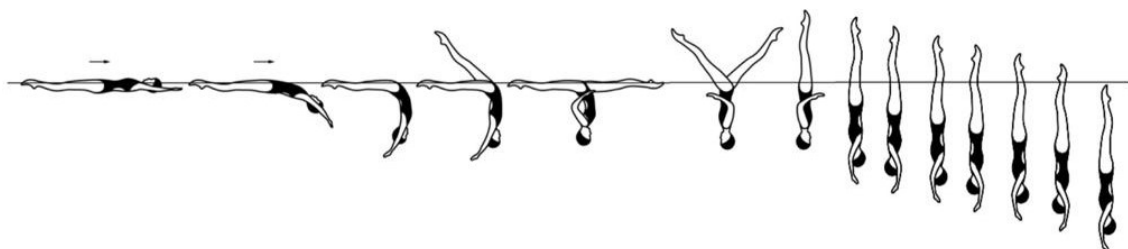

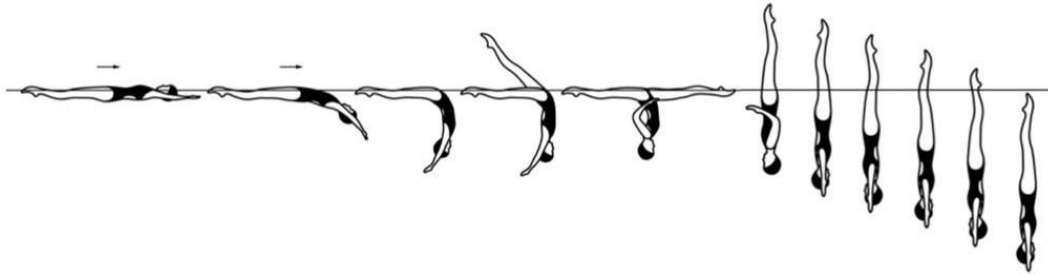

**1B – Walkover Back Closing 180° – Continuous Spin 720° / DD - 2.5**

From a **Back Layout Position** a *Surface Arch Position* is assumed. One leg is lifted in a 180° arc over the surface to a **Split Position**. A rotation of 180° is executed, as the legs symmetrically close to a **Vertical Position**. Continuing in the same direction a *Continuous Spin of 720°* (2 rotations) is executed.

**Element 2**

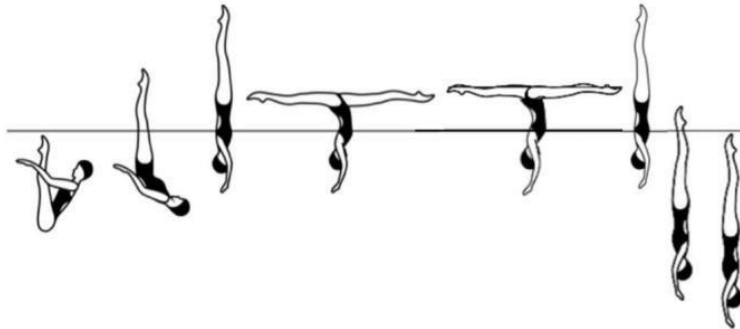
**2A – Rocket Split Alternating Legs – Spinning 180° / DD - 2.8**

From a **Submerged Back Pike Position**, with the legs perpendicular to the surface, a *Thrust* is executed to a **Vertical Position**. Maintaining maximum height, the legs are split rapidly to assume two alternating **Airborne Split Positions**. The legs rapidly re-join to a **Vertical Position**. A rapid *180° Spin* is executed.

**2B – Rocket Split – Spinning 180° / DD - 2.4**

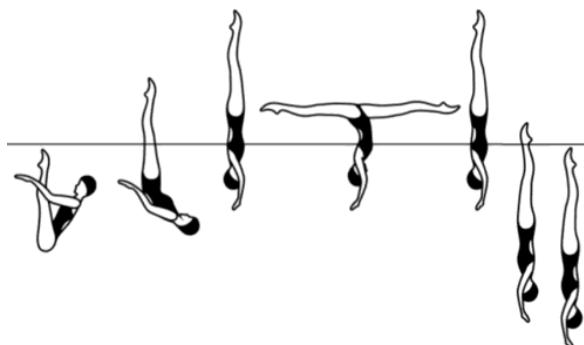
From a **Submerged Back Pike Position**, with the legs perpendicular to the surface, a *Thrust* is executed to a **Vertical Position**. Maintaining maximum height, the legs are split rapidly to assume an **Airborne Split Position**. The legs rapidly re-join to **Vertical Position**. A rapid *180° Spin* is executed.





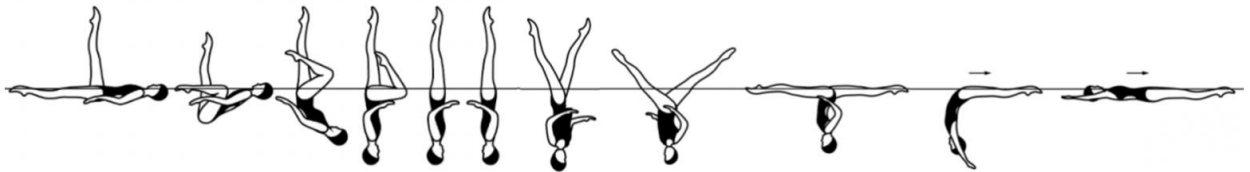

**Element 3**
**3 – Beginning from a Ballet Leg Position - Flamingo Bent Knee rollback - Join to VP – Half Twist – 360° open to Split – Walkout / DD 3.1**

From a **Surface Ballet Leg Double Position**, the shin of the horizontal legs drawn along the surface of the water to assume a **Surface Flamingo Position**. With the ballet leg maintaining its vertical position, the hips are lifted as the trunk unrolls, while the bent leg moves to a **Bent Knee Vertical Position**. The bent leg is extended to a **Vertical Position**. A *Half Twist* is executed. Continuing in the same direction and without a pause, an additional rotation of 360° is executed as the legs are symmetrically opened to assume a **Split Position**. A *Walkout Front* is executed

**Element 4**
**4A – Fishtail – Knight – Continuous Spin 1080° / DD - 3.2**

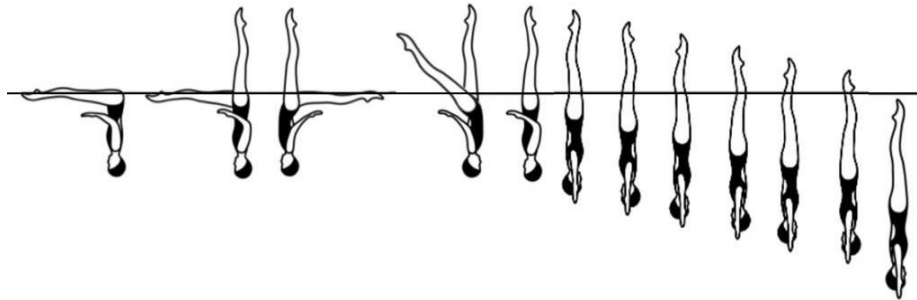
**A** – From a **Front Pike Position** one leg is lifted to a **Fishtail Position**. The horizontal leg is rapidly lifted through an arc of 180° to assume a **Knight Position**. A rapid *Full Twist* is executed as the horizontal leg is lifted to a **Vertical Position**. Continuing in the same direction a *Continuous Spin 1080° (3 rotations)* is executed.

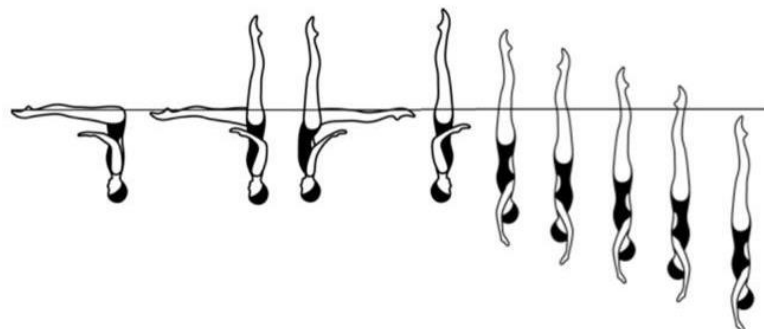

**4B – Fishtail – Knight – Continuous Spin 720° / DD - 2.7**

From a **Front Pike Position** one leg is lifted to a **Fishtail Position**. The horizontal leg is rapidly lifted through an arc of 180° to assume a **Knight Position**. A rapid *Half Twist* is executed as the horizontal leg is lifted to a **Vertical Position**. Continuing in the same direction a *Continuous Spin 720° (2 rotations)* is executed.



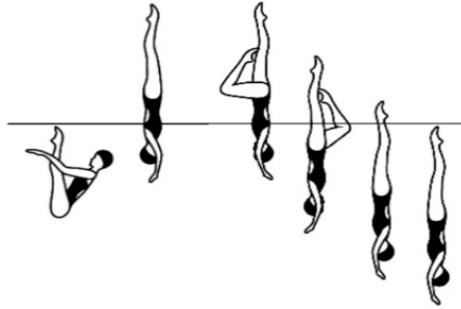

**Element 5**
**5A – Thrust Bent Knee Twirl Spin 360° / DD - 2.3**

From a **Submerged Back Pike Position**, with the legs perpendicular to the surface, a *Thrust* is executed to a **Vertical Position**. One leg is lowered to a **Bent Knee Vertical Position** as a *Twirl* is executed. Continuing in the same direction and without a pause a rapid *360° Spin* is executed as the bent knee is extended to join the vertical leg in a **Vertical Position** completed as the ankles reach the surface of the water, followed by a *Vertical Descent* at the same tempo as the *Thrust*.

**5B – Thrust – Bent Knee Twirl / DD 2.1**

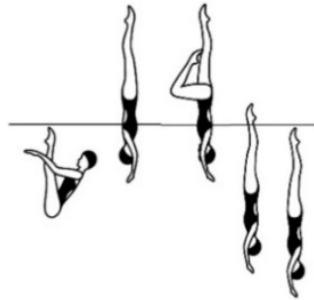
From a **Submerged Back Pike Position**, with the legs perpendicular to the surface, a *Thrust* is executed to a **Vertical Position**. One leg is lowered to a **Bent Knee Vertical Position** as a *Twirl* is executed. Without a pause a *Vertical Descent* is executed as the bent knee is extended to join the vertical leg in a **Vertical Position** completed as the ankles reach the surface of the water, followed by a *Vertical Descent* at the same tempo as the *Thrust*.



**Women's Duet Technical Routine Additional Requirements.**

- 6** - One (1) additional hybrid must be performed. It may be placed anywhere in the routine.
- 7** - One (1) Pair Acrobatic must be performed. It may be placed anywhere in the routine.

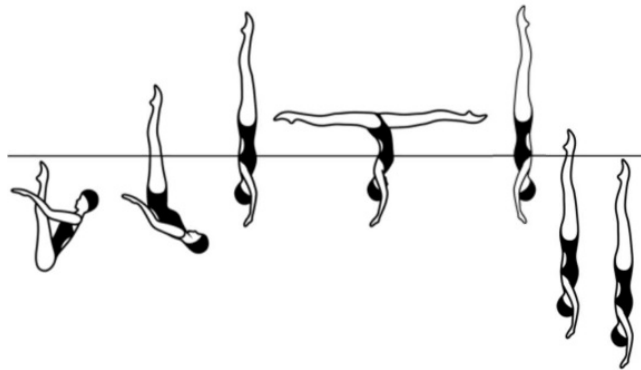

**29.2.4 Mixed Duet Required Elements**
**Element 1**
**1A – Rocket Split Twirl Spin 180° / DD – 2.7**

From a **Submerged Back Pike Position**, with the legs perpendicular to the surface, a *Thrust* is executed to a **Vertical Position**. Maintaining maximum height, the legs are split rapidly to assume an **Airborne Split Position**. A *Twirl* is executed, as the legs symmetrically close to a **Vertical Position**.

Continuing in the same direction a rapid *180° Spin* is executed.

**1B – Rocket Split Twirl / DD – 2.5**

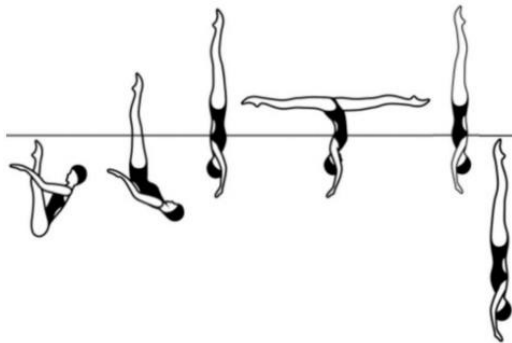
From a **Submerged Back Pike Position**, with the legs perpendicular to the surface, a *Thrust* is executed to a **Vertical Position**. Maintaining maximum height, the legs are split rapidly to assume an **Airborne Split Position**. A *Twirl* is executed, as the legs symmetrically close to a **Vertical Position**. A *Vertical Descent* is executed at the same tempo as the *Thrust*.

**Element 2**
**2A – Front Pike – Vertical 360° Rotation – Full Twist to Bent Knee – Continuous Spin 720° / DD 2.4**

From a **Front Pike Position**, the legs are lifted to **Vertical Position** as a rotation of 360° is executed. Continuing in the same direction a *Full Twist* is executed as one leg is lowered to a **Bent Knee Vertical Position**. Continuing in the same direction a *Continuous Spin 720°* (2 rotations) is executed as the bent knee is extended to join the vertical leg to a **Vertical Position** completed as the ankles reach the surface of the water and continues through submergence.

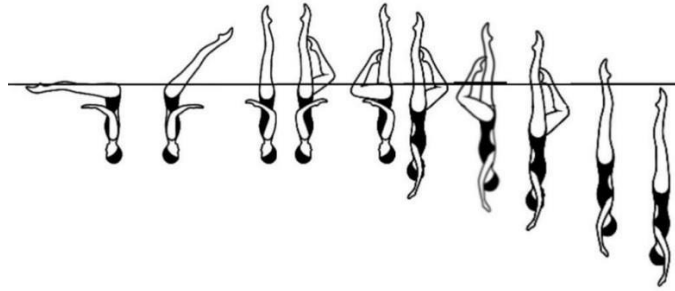
**2B – Front Pike – Vertical 180° Rotation – 1/2 Twist to Bent Knee – Continuous Spin 720° / DD 2.2**

From a **Front Pike Position**, the legs are lifted to **Vertical Position** as a rotation of 180° is executed. Continuing in the same direction a *Half Twist* is executed as one leg is lowered to a Bent Knee **Vertical Position**. Continuing in the same direction a *Continuous Spin 720°* (2 rotations) is executed as the bent knee is extended to join the vertical leg to a **Vertical Position** completed as the ankles reach the surface of the water and continues through submergence.

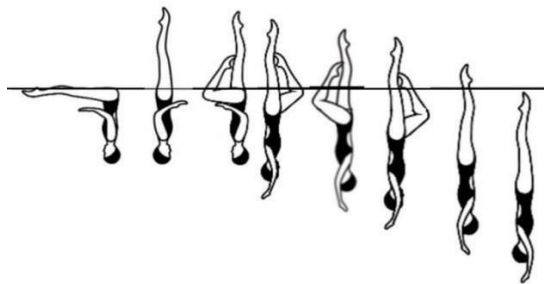
**Element 3**
**3 - Manta Ray Half Twist / DD 3.0**

Starting from a **Back Layout Position** a *Ballet Leg* is assumed and the shin of the horizontal leg is drawn along the surface of the water to assume a **Surface Flamingo Position**, traveling head first. With the ballet leg maintaining its vertical position, the hips are lifted as the trunk unrolls while the bent leg straightens with the knee at the surface of the water to assume a **Fishtail Position**. The horizontal leg is lifted to a **Vertical Position**, as the body rotates 180°. The direction of the 180° rotation is closing externally the horizontal leg. (Note: A right flamingo start requires the left shoulder back during the 180° rotation and a left flamingo start requires the right shoulder back during the 180° rotation). The legs are lowered rapidly simultaneously to a **Bent Knee Surface Arch Position**. (Note: The Bent Knee Surface Arch Position can be assumed by using either leg). The bent knee is straightened to a **Surface Arch Position** and with continuous motion, an *Arch to Back Layout Finish Action* is executed.

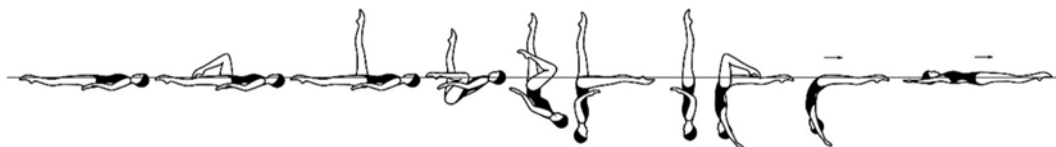



**Mixed Duet - Technical Routine Additional Requirements**

4 – One (1) free hybrid

5 – One (1) required hybrid which must contain only one Thrust declaration and two (2) different Connection declarations

6 – Two (2) Pair Acrobatics of free choice but must not repeat the same acrobatic

7 – 3 declared Sustained Surface Connections (“SuCon”) with travel (1m or more) or rotation (180° or more)

**Team Required Elements****Element 1****1A – Flying Fish Hybrid Spinning 180° / DD - 2.5**

From a **Submerged Back Pike Position** with the legs perpendicular to the surface, a *Thrust* is executed to a **Vertical Position** and with no loss of height one leg is rapidly lowered to an airborne **Fishtail Position**. Without a pause the horizontal leg is rapidly lifted to a **Vertical Position**, followed by a rapid *180° Spin*.

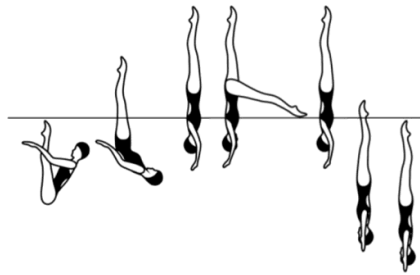

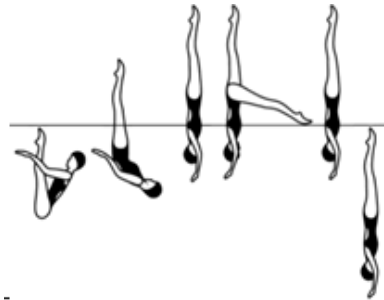

**1B – Flying Fish Hybrid / DD - 2.3**

From a **Submerged Back Pike Position** with the legs perpendicular to the surface, a *Thrust* is executed to a **Vertical Position** and with no loss of height one leg is rapidly lowered to an airborne **Fishtail Position**. Without a pause the horizontal leg is rapidly lifted to a **Vertical Position** followed by a *Vertical Descent*.

**Element 2**
**2A – Vertical – Full Twist to Bent Knee – Full Twist to Vertical – Open 180° – Walkout / DD - 2.6**

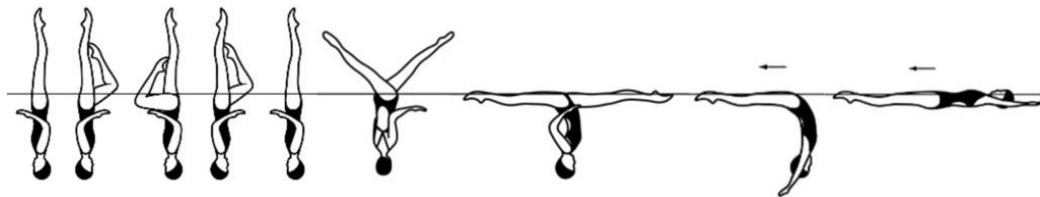
Starting in a **Vertical Position**, a *Full Twist* is executed as one leg is lowered to a **Bent Knee Vertical Position**. Continuing in the same direction another *Full Twist* is executed, as the bent knee is extended to a **Vertical Position**. Continuing in the same direction a *Half Twist* is executed as the legs are symmetrically lowered to a **Split Position**. A *Walkout Front* is executed.

**2B – Vertical – Half Twist to Bent Knee – Half Twist to Vertical – Split – Walkout / DD - 2.3**

Starting in a **Vertical Position**, a *Half Twist* is executed as one leg is lowered to a **Bent Knee Vertical Position**. Continuing in the same direction another *Half Twist* is executed, as the bent knee is extended to a **Vertical Position**. The legs are symmetrically lowered to a **Split Position**. A *Walkout Front* is executed.

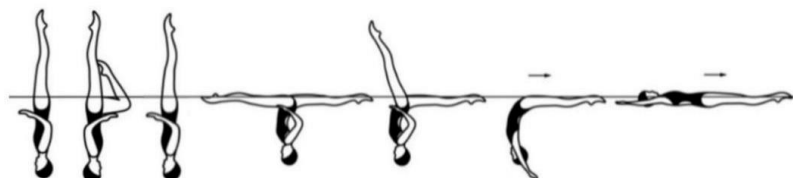

**Fouetté Rotation - New movement**

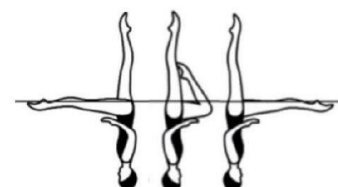
From a **Fishtail Position**, with the horizontal leg leading toward the vertical leg, a rapid 180° rotation is executed as the front leg bends to assume a **Bent Knee Vertical Position**. The bent leg rapidly extends to a **Fishtail Position**.



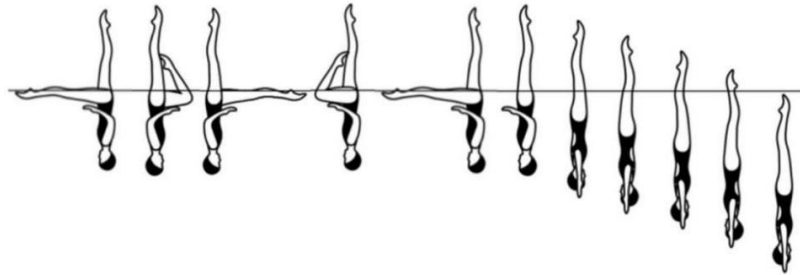

**Element 3**
**3A – Two Fouetté Rotations – Vertical – Continuous Spin 720° / DD – 2.6**

From a **Fishtail Position**, 2 *Fouetté rotations* (180°+180°) are executed. The horizontal leg is rapidly lifted to a **Vertical Position**. Continuing in the same direction a *Continuous Spin of 720°* (2 rotations) is executed.

**3B – Two Fouetté Rotations – Vertical – Spinning 360° / DD - 2.3**

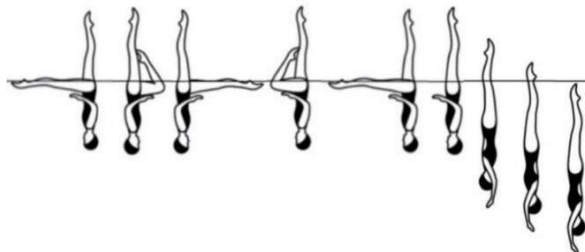
From a **Fishtail Position**, 2 *Fouetté rotations* (180°+180°) are executed. The horizontal leg is rapidly lifted to a **Vertical Position**. Continuing in the same direction, a rapid *Spinning 360°* (1 rotation) is executed.

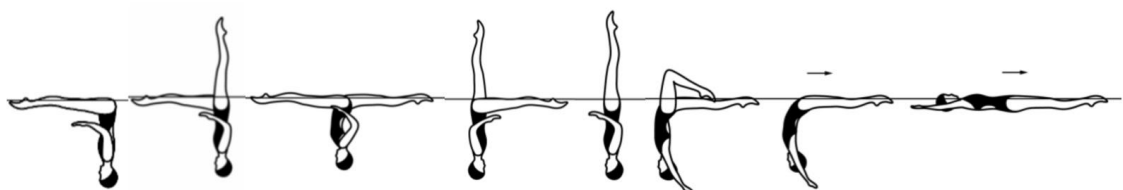

**Element 4**
**4 – Butterfly Hybrid / DD - 2.9**

The Butterfly Hybrid is to be performed rapidly. From a **Front Pike Position**, one leg is lifted to a **Fishtail Position**. The horizontal leg is lifted through an arc of 180° as the vertical leg is lowered to assume a **Split Position**. Without a pause a hip rotation of 180° is executed as the front leg is raised to assume a **Fishtail Position**. Continuing in the same direction a 180° rotation is executed as the horizontal leg is lifted to a **Vertical Position**. The legs are lowered simultaneously to a **Bent Knee Surface Arch Position**. (Note: The **Bent Knee Surface Arch Position** can be assumed by using either leg). The bent knee is straightened to a **Surface Arch Position** and with continuous motion an *Arch to Back Layout Finish Action* is executed.



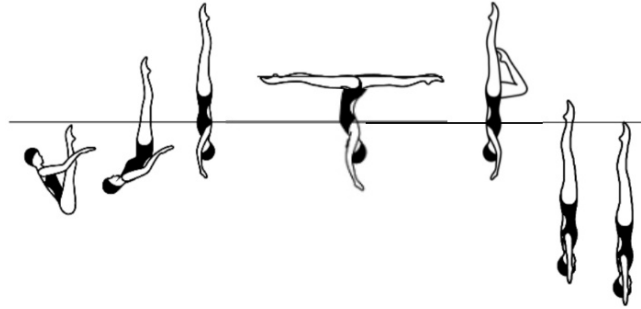

**Element 5**
**5A – Rocket Split Bent Knee Twirl Hybrid / DD - 2.4**

From a **Submerged Back Pike Position** with the legs perpendicular to the surface, a Thrust is executed to a **Vertical Position**. Maintaining maximum height, the legs are split rapidly to assume an **Airborne Split Position**, followed by a rapid rotation of 180° to assume an airborne **Bent Knee Vertical Position** with the front leg bent. A rapid *Vertical Descent* is executed as the bent knee is extended to join the vertical leg completed as the ankles reach the surface of the water followed by a *Vertical Descent*.

**5B – Rocket Split Bent Knee Hybrid / DD - 2.1**

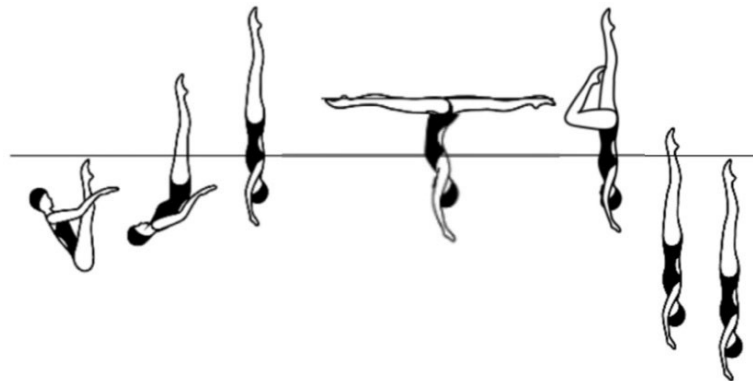
From a **Submerged Back Pike Position** with the legs perpendicular to the surface, a Thrust is executed to a **Vertical Position**. Maintaining maximum height, the legs are split rapidly to assume an **Airborne Split Position** followed by the front leg rapidly bending and the back leg rapidly lifting to a vertical to assume an airborne **Bent Knee Vertical Position**. A *Vertical Descent* is executed as the bent knee is extended to join the vertical leg completed as the ankles reach the surface of the water followed by a *Vertical Descent*.

**Team Technical Routine Additional Requirements. These may be placed anywhere in the routine.**

**6** - Two (2) additional hybrids, one of which must include a Cadence action,

**7** - One (1) acrobatic movement must be performed by all team members. The DD for the acrobatic movement *must not exceed 3.0 inclusive of Base Mark value.*

**Cadence Action:** Identical movement(s) performed sequentially, one by one, by all team members. When more than one cadence action is performed, they must be consecutive and not separated by other optional or required elements. A second cadence action may begin before the first cadence action is completed by all team members but each team member must do the action of each cadence.



**Acrobatic movements:** A general term for jumps, throws, lifts, stacks, platforms, etc., which are performed as spectacular gymnastic feats and/or risky actions, and are mostly achieved with assistance from other swimmer(s). An acrobatic movement is considered when it starts and ends once all team members are in the water.

A routine may contain a maximum of one circle pattern.

The direction of propulsion may vary as long as all swimmers are facing the same direction.

Variations in propulsion and direction facing are permitted only during underwater pattern changes, underwater actions, and getting into and finishing a circle.

**29.3 APPENDIX 3 - Set Numbers of Elements for Routines**

**Please note:** the requirement to include one declaration from each family in the routine (except for connections in Solo) is applicable for **Free Routines only**.

Senior/Junior	Time (+/- 5 sec)	Total Re- quired Ele- ments	Summary
Solo Tech	2:00	6	5 TRES 1 Free Hybrid
Solo Free	2:15	6	6 Free Hybrids <b>(must include one declaration from each family in the routine – except connections)</b>
Women Duet Tech	2:20	7	5 TRES 1 Free Hybrid 1 Pair Acro <b>(free choice)</b>
Women Duet Free	2:45	8	6 Free Hybrids <b>(must include one declaration from each family in the routine)</b> 2 Pair Acro <b>(free choice but may not repeat the same acrobatic)</b>
Mixed Duet Tech	2:20	7	3 TRES 1 Free Hybrid 1 Required Hybrid <b>(must contain only one Thrust declaration and 2 different Connection declarations – for example T8 C3 C4)</b> 2 Pair Acro <b>(free choice but must not repeat the same acrobatic)</b> 3 declared Sustained Surface Connections (“SuCon”) with travel (1m or more) or rotation (180° or more)
Mixed Duet Free	2:45	7	4 Free Hybrids <b>(must include one declaration from each family in the routine)</b> 3 Pair Acro <b>(free choice but must not repeat the same acrobatic)</b> A minimum of 4 declared Sustained Surface Connections (“SuCon”) with travel (1m or more) or rotation (180° or more)
Team Tech	2:50	8	5 TRES 2 Free Hybrids one of which must include a cadence action 1 Team Acro <b>(Max. DD limit of 3.0 inclusive of Base Mark Value)</b> May contain max of 1 circle
Team Free	3:30	9	6 Free Hybrids <b>(must include one declaration from each family in the routine)</b> 3 Team Acro <b>(free choice but must not repeat the same acrobatic – see below)</b>
Acrobatic	3:00	7	7 Acrobatics: One from A, B, C, P <b>Maximum of 2 acrobatics from any group</b> <b>Must not repeat the same acrobatic – see below</b>

*\* Must not repeat the same acrobatic is defined as follows (please also see the Team Acrobatic Catalogue for examples):*

*For Group A – can't repeat same position/s (as P1 or as P2), with the exception of the third position bonus*

*For Group B – can't repeat the same construction and can't repeat the same type of connection (grip)*

*For Group C – can't repeat the same construction*

*For Group P – can't repeat the same construction **AND** can't repeat the same type of connection (grip), **AND** can't repeat same position/s (as P1 or as P2), with the exception of the third position bonus*

\*Please note apnea limits are being removed – Artistic Impression factoring is being revised inclusive of implementing an increased value for Transitions.

**Please note:** the requirement to include one declaration from each family in the routine (except for connections in Solo) is applicable for 12U and Youth Free Routine Events



*\*In regards to 12 and Under – Federations can adapt based on their development goals for 12U*

<b>12U/Youth (13-15)</b>	<b>Time (+/- 5 sec)</b>	<b>Total Re- quired Ele- ments</b>	<b>Summary</b>
12U Solo Free	2:00	4	4 Free Hybrids <b>(must include one declaration from each family in the routine)</b>
Youth Solo Free	2:00	5	5 Free Hybrids <b>(must include one declaration from each family in the routine)</b>
12U Duet Free	2:30	5	4 Free Hybrids <b>(must include one declaration from each family in the routine)</b> 1 Pair Acro (free choice)
Youth Duet Free	2:30	6	5 Free Hybrids <b>(must include one declaration from each family in the routine)</b> 1 Pair Acro <b>(free choice)</b>
Mixed Duet Free (12U/Youth)	2:30	5	3 Free Hybrids <b>(must include one declaration from each family in the routine)</b> 2 Pair Acro <b>(free choice but must not repeat the same acrobatic)</b> A minimum of 3 declared Sustained Surface Connections ("SuCon") with travel (1m or more) or rotation (180° or more)
12U Team Free	3:00	7	4 Free Hybrids <b>(must include one declaration from each family in the routine)</b> 3 Team Acrobatics with DD safety limit <b>(free choice but must not repeat the same acrobatic – see below)</b>
Youth Team Free	3:00	8	5 Free Hybrids <b>(must include one declaration from each family in the routine)</b> 3 Team Acrobatics with DD safety limit <b>(free choice but must not repeat the same acrobatic – see below)</b>
12U Combo	3:00	8	3 Team Acrobatics with DD safety limit <b>(free choice but must not repeat the same acrobatic – see below)</b> 1 x DD Solo Hybrid 1 x DD Duet Hybrid 2 x Team DD Hybrid <b>(must be executed with a minimum of 4 athletes)</b> <b>Must include one declaration from each family in the routine (counted across solo, duet and team DD hybrids)</b> 1 x Team choreography hybrid ("ChoHY") with no DD (ie factor of 1,0) <b>must be executed with a minimum of 4 athletes</b> <b>Element parts can't occur simultaneously (ie Team Acrobatic occurs while solo hybrid starts)</b>
Youth Combo	3:00	9	4 Team Acrobatics with DD safety limit <b>(free choice but must not repeat the same acrobatic – see below)</b> 1 x DD Solo Hybrid 1 x DD Duet Hybrid 2 x Team DD Hybrid <b>(must be executed with a minimum of 4 athletes)</b> <b>Must include one declaration from each family in the routine (counted across solo, duet and team DD hybrids)</b> 1 x Team choreography hybrid ("ChoHY") with no DD (ie factor of 1,0) <b>must be executed with a minimum of 4 athletes</b> <b>Element parts can't occur simultaneously (ie Team Acrobatic occurs while solo hybrid starts)</b>



12U and Youth Team Acrobatic Safety Limits for Team and Combo events are as follows. Acrobatic elements cannot have a DD higher than the Total DD (MAX):

	<b>Acro DD</b>	<b>Plus Base Mark</b>	<b>Total DD (MAX)</b>
Youth - Group A	2.2	0.5	<b>2.7</b>
Youth - Group B	2.3	0.5	<b>2.8</b>
Youth - Group C	2.3	0.5	<b>2.8</b>
Youth - Group P	2.5	0.5	<b>3.0</b>
12U - Group A	2.0	0.5	<b>2.5</b>
12U - Group B	2.1	0.5	<b>2.6</b>
12U - Group C	2.1	0.5	<b>2.6</b>
12U - Group P	2.3	0.5	<b>2.8</b>

*\* Must not repeat the same acrobatic is defined as follows (please also see the Team Acrobatic Catalogue for examples):*

*For Group A – can't repeat same position/s (as P1 or as P2), with the exception of the third position bonus*

*For Group B – can't repeat the same construction and can't repeat the same type of connection (grip)*

*For Group C – can't repeat the same construction*

*For Group P – can't repeat the same construction **AND** can't repeat the same type of connection (grip), **AND** can't repeat same position/s (as P1 or as P2), with the exception of the third position bonus*

*\*Please note apnea limits are being removed – Artistic Impression factoring is being revised inclusive of implementing an increased value for Transitions.*



**29.4 APPENDIX 4 - REQUIRED ELEMENTS FOR ACROBATIC ROUTINE****29.4.1 General Requirements**

- 1) Time Limits as in Part Seven 14.1
- 2) Start may be on the deck or in the water, or a combination of both.
- 3) Required Technical Element #1 may be performed in any order
- 4) A maximum of 2 acrobatics from any group (A, B, C or P) may be performed
- 5) Acrobatics must not be repeated. Must not repeat the same acrobatic is defined as:
  - For Group A – can't repeat same position/s (as P1 or as P2), with the exception of the third position bonus
  - For Group B – can't repeat the same construction and can't repeat the same type of connection (grip)
  - For Group C – can't repeat the same construction
  - For Group P – can't repeat the same construction, AND can't repeat the same type of connection (grip), AND can't repeat same position/s (as P1 or as P2), with the exception of the third position bonus
- 6) The Routine must portray a Theme, which must be declared on the Card.
- 7) As in all routines, the Coach Card must show the Required Technical Elements in the selected order of performance.

**29.4.2 Acrobatic Required Technical Elements**

- 1) Seven (7) acrobatic movements: one from each acrobatic group (A, B, C, P), and three (3) more of free choice as per the general requirements.

**Acrobatic movement:** is a general term for jumps, throws, lifts, stacks, platforms, etc., which is performed as spectacular gymnastic feats and/or risky actions and is mostly achieved with assistance by another swimmer(s).

**29.5 APPENDIX 5 - REQUIRED ELEMENTS FOR THE FREE COMBINATION**
**29.5.1 General Requirements**

- 1) Time Limits: as per Part Seven, Article 14.1
- 2) Start may be on the deck or in the water, or a combination of both.
- 3) All subsequent parts must start in the water
- 4) A new part begins in very close proximity to the previous part
- 5) The Routine must portray a Theme which must be declared on the Coach Card.
- 6) As in all routines, the Coach Card must show the Required Elements in the selected order of performance.

**29.5.2 Required Elements**

- 1) At least two (2) parts must have fewer than three (3) competitors and at least two (2) parts must have all competitors.
- 2) As per Appendix 3 Youth Free Combination must include:
  - a. 4 Team Acrobatics with DD safety limit (free choice but must not repeat the same acrobatic)
  - b. 1 x DD Solo Hybrid
  - c. 1 x DD Duet Hybrid
  - d. 2 x Team DD Hybrid (must be executed with a minimum of 4 athletes)
  - e. 1 x Team choreography hybrid with no DD (ie factor of 1.0) must be executed with a minimum of 4 athletes
  - f. Element parts can't occur simultaneously (ie Team Acrobatic occurs while solo hybrid starts)
- 3) As per Appendix 3 the 12U Free Combination must include:
  - a. 3 Team Acrobatics with DD safety limit (free choice but must not repeat the same acrobatic)
  - b. 1 x DD Solo Hybrid
  - c. 1 x DD Duet Hybrid
  - d. 2 x Team DD Hybrid (must be executed with a minimum of 4 athletes)
  - e. 1 x Team choreography hybrid with no DD (ie factor of 1.0) must be executed with a minimum of 4 athletes
  - f. Element parts can't occur simultaneously (ie Team Acrobatic occurs while solo hybrid starts)
- 4) 12U and Youth Team Acrobatic Safety Limits for Free Combination is as follows. Acrobatic elements cannot have a DD higher than the Total DD (MAX):

	<b>Acro DD</b>	<b>Plus Base Mark</b>	<b>Total DD (MAX)</b>
Youth - Group A	2.2	0.5	<b>2.7</b>
Youth - Group B	2.3	0.5	<b>2.8</b>
Youth - Group C	2.3	0.5	<b>2.8</b>
Youth - Group P	2.5	0.5	<b>3.0</b>
12U - Group A	2.0	0.5	<b>2.5</b>
12U - Group B	2.1	0.5	<b>2.6</b>
12U - Group C	2.1	0.5	<b>2.6</b>
12U - Group P	2.3	0.5	<b>2.8</b>



5) Acrobatics must not be repeated. Must not repeat the same acrobatic is defined as:

- For Group A – can't repeat same position/s (as P1 or as P2), with the exception of the third position bonus
- For Group B – can't repeat the same construction and can't repeat the same type of connection (grip)
- For Group C – can't repeat the same construction
- For Group P – can't repeat the same construction, AND can't repeat the same type of connection (grip), AND can't repeat same position/s (as P1 or as P2), with the exception of the third position bonus

**29.6 APPENDIX 6 - HYBRID CATALOGUE (VERSION 5.1)**
**Introduction**

- 1) World Aquatics documents written word will prevail over any other documents or video examples (AQUA or otherwise).
- 2) As stated in the AS Manual regarding judging routines, the same principle shall also apply for TCs: Hybrids may be performed close to or far from TCs position and/or in moving water caused by the (intentional) power of actions, the number of athletes performing, or the moving progression (“travelling”) of the Hybrid, as such TCs must focus on what they see at or over the water surface.
- 3) In regard to any hybrid techniques where compliance to specific angles or height levels is required:
  - If technology is available at a competition where athletes can be *accurately measured* via analysis software for compliance to stated angles or height levels, then clear non-compliance to a required angle or level would result in a Base Mark
  - For Technical Controllers without technology – then non-compliance to a required angle or height level should be *very obvious* and clear in a video review (so far off the angle/height that there is no doubt). If too close to call and in doubt, then the ruling should go in favour of the athlete.

**Hybrids**
**Definition of a Hybrid:**

- 1) A free hybrid (one intentionally being declared for DD on a Coach Card) is defined as having a combination of five (5) or more movements performed with lower limbs with intentional apnea (head down under hips level).
- 2) Short hybrid-like movements of 4 or less movements with or without intentional apnoea OR horizontal movements along the surface with lower limb actions that have consequential apnoea (rolling over, kicking, etc.) are considered as transitional movements.

**How to count hybrid movements:**

- 1) The Definition of a Hybrid Movement = a definitive change in the position or direction of the lower limbs as mandated by the choreography of the routine.
- 2) Regarding entries and exits:
  - Front Pike Pulldown - the action of the body bending into the pike position is movement number one, with counting continuing from there
  - Entry from a Ballet Leg - A Ballet Leg kick counts in the hybrid if used as an entry into the hybrid (kick up and then a Catalina like rotation, kick up and then into inverted tuck, etc.)
  - If starting from underwater, start counting from the first position – for example a pike, tuck, tabletop, or a submerged back pike (before a thrust)
  - No movements shall be counted underwater – for example, a tuck from ankles at the end of a spin would count as one movement, however if the athlete(s) tuck when completely submerged no movement shall be counted
  - Spins / Twists / Twirls: each ½ turn (180o) shall count as 1 movement
  - A “swirl” action counts as one movement from it’s beginning to its clear stopping point or next clear action as momentum/force must be considered.
  - Fast kick type actions (for example fast “tendu” like action similar to ballet: movement in ballet where the working leg is extended along the floor until only the tip of the toe remains touching the floor) shall count as 1 movement (i.e. there is a clear exertion of energy/muscle tension and then a recovery)
  - When rotating and performing leg movements at the same time, only the rotations shall be counted.



- Cadence: each cadence movement shall count as 1 movement. You do not count the movements of each athlete as they all do the same action, but on their own counts.

**Hybrid difficulty components:**

- 1) Hybrid difficulty components are declared skills with assigned degree of difficulty (DD) values that comprise transitions in a hybrid and are grouped in the following "families" by level:
  - THRUSTS (T)
  - SPINS (S)
  - TWISTS (R) – which include Twirls and Swirls
  - FLEXIBILITY (F)
  - AIRBORNE WEIGHT (A)
  - CONNECTIONS (C)
- 2) All families include a first level which is defined as Basic (B), then each family progresses from level 1 upwards to a maximum of level 10.

**Bonuses:**

- 1) Team Tech, Team Free and Free Combination routines shall include a bonus for each Pattern Change executed valued at 0.20 each

**Hybrid Base Mark:**

- 1) Base Mark for all hybrids is the same and has a value of 0.5.
- 2) The Hybrid Base Mark value of 0.5 is added to the value of the hybrid DD, and it is the value (0.5) the hybrid will go to if not successful in achieving the declared difficulty.
- 3) Total Hybrid Declared Difficulty (DD) Value  
 $= \text{BASE MARK (0.5)} + \text{MOVEMENTS (Families)} + \text{BONUS (Team only)}$

**29.6.1 Families of movements**
**Thrusts (T)**

The Thrust (T) family includes variations of thrusts as defined in AS Rulebook BM: *“From a Submerged Back Pike Position with the legs perpendicular to the surface of the water a vertical upward movement of the legs and hips is rapidly executed as the body unrolls to assume a Vertical Position\*.* Maximum height desirable”.

*\*Note: other 1 and 2 leg body positions are allowed as per the Thrust levels defined.*

- Whenever “Thrust” is stated it means two legs, otherwise one leg is stated.
- The minimum height for a Thrust to be able to be accepted is a 3.5 (Dynamic height) which is *above the knees*, meaning TCs must clearly see that height level achieved, or the thrust will be subject to Base Mark.

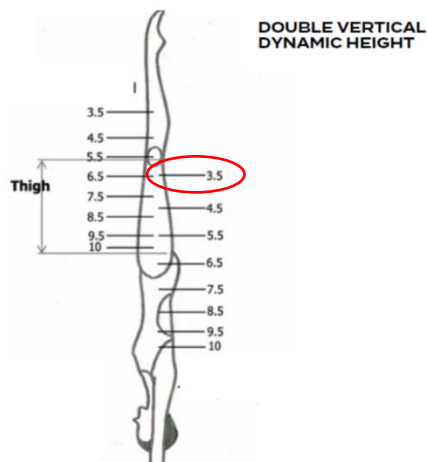

- Thrust endings with crashing OR with descent are clearly differentiated and defined in the difficulty table at different levels and values.

For a Thrust and vertical descent

- If a descent is executed from maximum height until below the knee (kneecaps submerged) and then a crash occurs, this still applies as an accomplished descent.
- A Thrust with flexibility must exhibit flexibility at maximum height like Airborne Split Position or Vertical to Knight. A thrust with Airborne Split Position or a split variant must show body alignment under hips, as described in BP and must show flexibility at minimum of “scissors (90°) / 0.1-2.9 for split as per the AS Manual. Body alignment means lower back arched, with hips, shoulders, and head on a vertical line. Split variants may not exhibit bent front legs, and only back legs that bend downward (with the knee facing the ceiling / not inward).

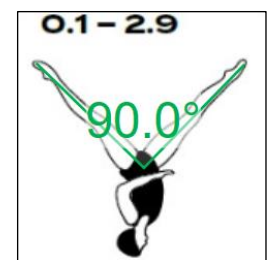

- For thrusts with flexibility followed by a spin or twirl, the spin or twirl can begin at any time – ie the legs can be out of the VP cone.
- For thrusts followed by a Twirl = A rotation at a sustained height - height remains constant throughout the rotation. Therefore, any obvious change in height downwards is subject to a Base Mark. “Obvious” is defined as a drop in two height levels. So, if the athlete starts above their knee (6.5) and drops to below knee (4.5) that would be a Base Mark. A change in one height level = execution.
- In the case that a thrust is performed that exhibits actions from different levels – declare the most difficult movement. For example, if a Thrust with Flexibility continued by catching (clearly stopping – stable height demonstrated) in a Vertical Position above the knees is performed, declare a T9.



- Regarding a Thrust Level 9 with catching: Once the “stable height demonstrated for 1 second (1s) or more” in VP has occurred any difficulty movement can then be performed and be declared as per the rules, for example: T9 followed by A6, S3, etc.
- Spins following Thrusts *must drop gradually*. Athletes who obviously hold the rotation at the ankle level (ie twisting vs spinning) will be subject to a Base Mark as per below standards:
  - For Spin 180° to Spin 720°  
Entire rotation must be gradual
  - For Spin 1080°  
A maximum of one rotation at the ankle level is allowed

Level	Code	Description	DD Value
B	<b>TB</b>	Thrust with one or two legs followed by crashing on the surface	<b>0.30</b>
1	<b>T1</b>	Thrust with one leg followed by vertical descent	<b>0.45</b>
2	<b>T2a</b>	Thrust with one leg followed by Spin 180°	<b>0.50</b>
	<b>T2b</b>	Thrust with one leg followed by Twirl 180° and a crash	
3	<b>T3a</b>	Thrust and vertical descent	<b>0.65</b>
	<b>T3b</b>	Thrust with one leg followed by Spin 360°	
	<b>T3c</b>	Thrust with one leg followed by Twirl 180° and descent	
	<b>T3d</b>	Thrust with flexibility followed by crashing	
4	<b>T4a</b>	Thrust with one leg followed by Spin 720°	<b>0.80</b>
	<b>T4b</b>	Thrust with flexibility and descent	
	<b>T4c</b>	Thrust followed by Spin 180°	
	<b>T4d</b>	Flying Fish (with descent) <i>A thrust is executed to a Vertical Position and with no loss of height one leg is rapidly lowered to an airborne Fishtail Position*. After the Flying Fish the join may be with a straight or bent leg followed by a vertical descent. The declaration ends with the descent.</i> <i>*The bottom leg must be out of the “VP cone” area</i> <i>**Reminder you may not combine with a rotation or vertical descent declaration</i>	
	<b>T4e</b>	Thrust followed by Twirl 180° and a crash	



5	<b>T5a</b>	Thrust followed by Spin 360°	<b>0.90</b>
	<b>T5b</b>	Thrust followed by Twirl 180° and descent	
	<b>T5c</b>	Thrust with flexibility followed by Spin 180°	
	<b>T5d</b>	Flying Fish Spin 180° or Thrust Fishtail Helicopter Spinning 180° <i>Same definition as T4 Flying Fish with a Spin 180° as ending</i>	
	<b>T5e</b>	One leg Thrust with Twirl 180° followed by Spin 360°	
6	<b>T6a</b>	Thrust with flexibility followed by Spin 360°	<b>1.10</b>
	<b>T6b</b>	Thrust with Twirl 180° followed by Spin 360°	
	<b>T6c</b>	Flying Fish 360° or Thrust Fishtail Helicopter Spinning 360° <i>Same definition as T4 Flying Fish with a Spin 360° as ending</i>	
7	<b>T7</b>	Thrust followed by Spin 720°	<b>1.50</b>
8	<b>T8</b>	Thrust with flexibility followed by Spin 720°	<b>1.70</b>
9	<b>T9a</b>	Thrust to height of 8.5 (waist) or higher followed by Spin 1080° or more	<b>2.00</b>
	<b>T9b</b>	Thrust to height of 8.5 (waist) or higher continued by catching (clearly stopping - stable height demonstrated for 1s or more) in a VP above the knees or higher	

### Spins (S)

This family includes all types of Spins – which is a rotation in a Vertical Position (as per general principles). It includes ascending/descending spins and combined/reversed combined spins.

When spin is stated, it can be either an ascending or descending spin (same code and value) – ascending and descending are NOT differentiated.

- For descending spins in *free hybrids*, the definition of degrees is by the submersion of the toes, OR when the rotation has come to a complete stop at the ankles level. Please note this is different than for Figures or Technical Required Elements (see BM 13).
- For ascending spins in *free hybrids*, the definition of degrees begins when the toes break the water's surface, OR at the ankles level. Please note this is different than for Figures or Technical Required Elements (see BM 13).

Spin allowances (BM 12 and 13) *do not apply* to spin declarations in *free hybrids*. Athletes must fully complete rotations as declared on the Coach Card. For example, if a S2 is declared (Spin 720° with one or two legs), then the Technical Controllers will be watching for completion of at least a full 720°. Rotating more than declared is ok, rotating less than declared is subject to a Base Mark.





A minimum height of 3.5 as per single and double leg height chart must be demonstrated to start a spin descending and a minimum height of 3.5 as per single and double leg height chart must be demonstrated to finish a spin ascending:

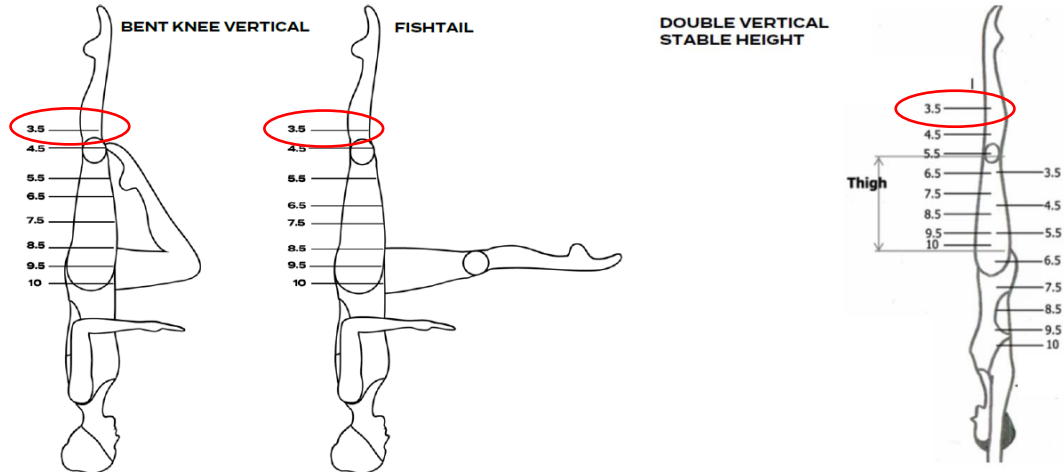

- A spin (ascending or descending) is defined as a gradual change of a minimum of two height levels *which must always end at the ankles or the submersion of the toes*. A change of only one height level during a spin declaration would be subject to Base Mark.
- Ascending and descending spins must rise/drop gradually. Athletes who obviously hold the rotation at the same height level (ie twisting vs spinning) will be subject to a Base Mark as per below standards:

**For Levels SB-S2**

Entire rotation must be gradual

**For Levels S3-S5**

A maximum of one rotation at each height level is allowed

**For Levels 6-10**

A maximum of two rotations at each height level is allowed

- Spin Level Basic (B), Level 1 and Level 2, are for spins with *one or two legs*. Beginning at level 3 all spins must be performed with *two legs*.
- Spins shall have the rotation of the **BODY** counted **“wall-to-wall”** to accomplish the declared degree of rotation. For rotations of 360° or more - the wall or direction you start at is the wall or direction you must finish for TCs to verify completion of rotation. Rotating more than declared is ok, rotating less than declared is subject to a Base Mark.
- Various modifications of leg positions during spins are allowed as long as the one or two leg position meets the definition of VP as per General Principle a). Unbalanced or off-angle spins are not differentiated, and those movements would be considered in artistic impression.
- When “two legs” is stated, it means VP definition (two legs within 45° of vertical), and “one leg” means one leg within 45° of vertical. Both as per general principle a).
  - Spins with one leg includes Bent Knee Vertical Position, Fishtail/Crane, Knight, and other one leg VP position options or variants.
  - Rotations with two legs includes Vertical Position “VP”, Fishtail within 45° of Vertical, Arched VP and other positions where 2 legs are clearly visible within 45° of the vertical line.
  - Joining/opening/bending/extending movements from one leg positions to two leg (VP) positions (or two-leg to one leg positions) such as Bent Knee VP/Fishtail to VP or VP to Bent Knee VP/Fishtail, are considered in all “one leg” spin classifications.



- A Combined or Reverse Combined Spin (defined in the table as “Combined”) will be counted only in the case of an equal number of descending and ascending or ascending and descending rotations with no stop that start and finish at the same height (for example if toes breaking the surface is beginning of spin, then toes submerging must be the end).

A Combined or Reverse Combined Spin in Levels Basic, 1 and 2 where it states, “one or two legs” MAY include a combination of one and two legs

- Example 1: starting in a Bent Knee VP, spin descending 360 while joining to VP, and then spin ascending 360 staying in VP
- Example 2: starting in a Bent Knee VP, spin descending 360 while joining to VP, then ascending spin 360 while returning to a Bent Knee VP
- Ascending and descending during Combined or Reverse Combined Spins (including Two-Direction) must rise/drop gradually. Athletes who obviously hold the rotation at the same height level (ie twisting vs spinning) will be subject to a Base Mark as per below standards:

**For Levels SCB-SC2 / SCDB-SCD2**

Entire rotation must be gradual

**For Levels SC3-SC5 / SCD3-SCD5**

A maximum of one rotation at each height level is allowed

**For Level SC6 / SCD6**

A maximum of two rotations at each height level is allowed

- A “Two-Direction” Spin means a spin in one direction, followed without a pause by an equal spin in the opposite direction. For example:

SCD2 - Combined 720° (one or two legs) = a descending or ascending rotation of 720° followed without a pause by an ascending or descending rotation of 720° in the opposite direction.

Level	Code	Description	DD Value
B	<b>SB</b>	Spin 180° (one or two legs)	<b>0.15</b>
	<b>SCB</b>	Combined 180° (one or two legs)	<b>0.35</b>
	<b>SCDB</b>	Two-direction Combined 180° (one or two legs)	<b>0.40</b>
1	<b>S1</b>	Spin 360° (one or two legs)	<b>0.35</b>
	<b>SC1</b>	Combined 360° (one or two legs)	<b>0.80</b>
	<b>SCD1</b>	Two-direction Combined 360° (one or two legs)	<b>0.85</b>
2	<b>S2</b>	Spin 720° (one or two legs)	<b>0.75</b>
	<b>SC2</b>	Combined 720° (one or two legs)	<b>1.60</b>
	<b>SCD2</b>	Two-direction Combined 720° (one or two legs)	<b>1.65</b>
3	<b>S3</b>	Spin 1080° (two legs)	<b>1.15</b>
	<b>SC3</b>	Combined 1080° (two legs)	<b>2.40</b>
	<b>SCD3</b>	Two-direction Combined 1080° (two legs)	<b>2.45</b>



4	<b>S4</b>	Spin 1440° (two legs)	<b>1.55</b>
	<b>SC4</b>	Combined 1440° (two legs)	<b>3.20</b>
	<b>SCD4</b>	Two-direction Combined 1440° (two legs)	<b>3.25</b>
5	<b>S5</b>	Spin 1800° (two legs)	<b>1.95</b>
	<b>SC5</b>	Combined 1800° (two legs)	<b>4.00</b>
	<b>SCD5</b>	Two-direction Combined 1800° (two legs)	<b>4.05</b>
6	<b>S6</b>	Spin 2160° (two legs)	<b>2.35</b>
	<b>SC6</b>	Combined 2160° (two legs)	<b>4.80</b>
	<b>SCD6</b>	Two-direction Combined 2160° (two legs)	<b>4.85</b>
7	<b>S7</b>	Spin 2520° (two legs)	<b>2.75</b>
8	<b>S8</b>	Spin 2880° (two legs)	<b>3.15</b>
9	<b>S9</b>	Spin 3240° (two legs)	<b>3.55</b>
10	<b>S10</b>	Spin 3600° (two legs)	<b>3.95</b>

#### TWISTS including Twirls/Swirls (R)

This family includes Twists and Twirls (as defined in AS Rulebook BM - the body remains on its longitudinal axis throughout the rotation) and Swirls.

- Twisting or Twirling = A rotation at a sustained height - height remains constant throughout the rotation. Therefore, any **obvious** change in height **downwards** will be subject to a Base Mark. A change in height upwards will be considered in execution. **“Obvious”** is defined as a **drop in two height levels**. So, if the athlete starts above their knee (6.5) and drops to below knee (4.5) that would be a Base Mark. A change in one height level = execution.
- The minimum height for a Twist to be able to be accepted is a 3.5 (as per single and double leg height chart) meaning TCs must clearly see that height level achieved, or the Twist will be subject to Base Mark.

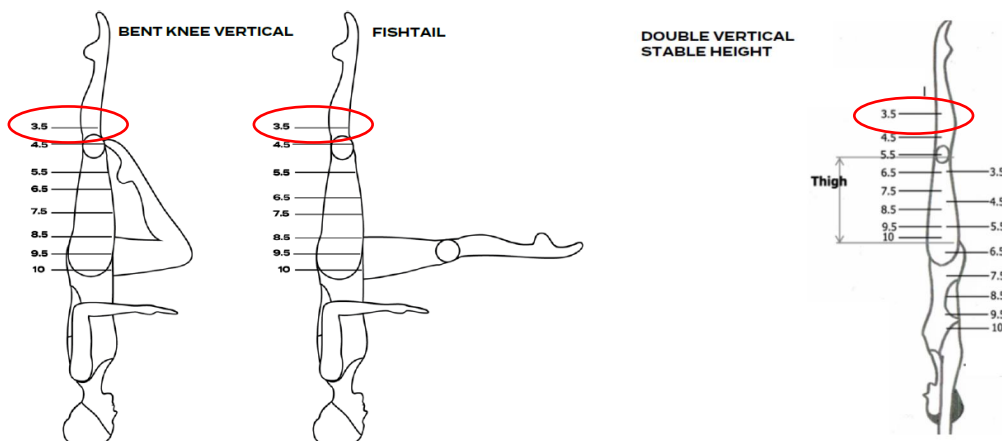

- Swirl = A 1 or 2 leg rotation in a piked/arched body position (or other positions where body is not aligned with its vertical axis), while turning. Swirls may have height variation - the legs can be lower than VP definition or can move in and out of VP area.



- Twist allowances (BM 12 and 13) do not apply to twist/twirl/swirl declarations in Free Hybrids. Athletes must fully complete rotations as declared on the Coach Card. For example, if an 2R3 is declared - Twist 1080o (VP), then the Technical Controllers will be watching for completion of at least a full 1080o. Rotating more than declared is ok, rotating less than declared is subject to a Base Mark.
- Twists, Twirls and Swirls shall have the rotation of the BODY counted “wall-to-wall” to accomplish the declared degree of rotation. For rotations of 360o or more - the wall or direction you start at is the wall or direction you must finish for TCs to verify completion of rotation. Rotating more than declared is ok, rotating less than declared is subject to a Base Mark.
- Various modifications of leg positions during rotations are allowed as long as the one or two leg position meets the definition of VP and the requirement to complete rotations (as per above point)
- For ROB, RO1, RCB and RC1, the legs may be slightly bent during the rotation
- Rotations with one leg includes Bent Knee Vertical Position, Fishtail, Crane, and other position options. Please note that Knight rotations are included in the Flexibility Family, however, if a Knight is done as a 1 leg rotation declaration (1RB, 1R1, etc.) this is ok (not Base Mark).
- Rotations with two legs includes Vertical Position “VP”, Fishtail within 45o of Vertical, Arched VP and other positions where 2 legs are clearly visible within 45o of the vertical line.
- Joining/opening/bending/extending movements from one leg positions to two leg (VP) positions (or two-leg to one leg positions) such as Bent Knee VP/Fishtail to VP or VP to Bent Knee VP/Fishtail, are considered in all “1 leg only” twist/twirl classifications.
- Please see general principles on p.24-27 for definition of unbalanced
- Unbalanced one leg twists are considered in all “1 leg” rotation classifications.
- A Two-direction Twist means a rotation in one direction, followed without a pause by an equal rotation in the opposite direction. For example:
  - RD1 - Two-Direction 360° (VP) = a rotation of 180° in one direction followed without a pause by a rotation of 180° in the opposite direction.
  - RD2 - Two-Direction 720° (VP) = a 360° rotation in one direction followed without a pause by a rotation of 360° in the opposite direction.
- For VP open 180°/360° to Split (ROB/RO1) by the halfway point (90°/180°) the legs must be at least at 45° – meaning the opening must be *gradual* (not a twirl 360° then open to split rapidly). Also – the starting “VP” position must begin with feet/ankles touching.
- Split close 180°/360° to VP (RCB/RC1) must not reach the VP until 135°/270° – meaning if close (where feet/ankles must be touching) finishes at ¾ point and then a ¼ turn in VP occurs that is ok, *however if less than 135°/270° accomplished* – the rotation would be subject to Base Mark.
- For ROB, RO1, RCB and RC1, Split position must show flexibility at minimum of “scissors (90°) / O.1-2.9 for split as per the AS Manual.

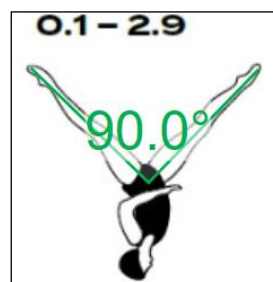



Level	Code	Description	DD Value
B	<b>RB</b>	Swirl 180°/Turn 180° non-sustained or up-down	<b>0.10</b>
	<b>1RB</b>	1 leg Twist/Twirl 180°	<b>0.15</b>
	<b>2RB</b>	Twist/Twirl 180° (VP)	<b>0.20</b>
	<b>ROB</b>	VP open 180° to Split	<b>0.25</b>
	<b>RCB</b>	Split close 180° to VP	<b>0.25</b>
1	<b>R1</b>	Swirl 360°/Turn 360° non-sustained or up-down	<b>0.20</b>
	<b>1R1</b>	1 leg Twist/Twirl 360°	<b>0.35</b>
	<b>2R1</b>	Twist/Twirl 360° (VP)	<b>0.45</b>
	<b>RD1</b>	Two-direction 360° (VP)	<b>0.50</b>
	<b>RU1</b>	Unbalanced Twist/Twirl 360° (VP)	<b>0.55</b>
	<b>RO1</b>	VP open 360° to Split	<b>0.55</b>
	<b>RC1</b>	Split close 360° to VP	<b>0.55</b>
2	<b>R2</b>	Swirl 720°	<b>0.40</b>
	<b>1R2</b>	1 leg Twist 720°	<b>0.75</b>
	<b>2R2</b>	Twist 720° (VP)	<b>0.95</b>
	<b>RD2</b>	Two-direction 720° (VP)	<b>1.05</b>
	<b>RU2</b>	Unbalanced Twist 720° (VP)	<b>1.15</b>
3	<b>R3</b>	Swirl 1080°	<b>0.60</b>
	<b>1R3</b>	1 leg Twist 1080°	<b>1.15</b>
	<b>2R3</b>	Twist 1080° (VP)	<b>1.45</b>
	<b>RU3</b>	Unbalanced Twist 1080° (VP)	<b>1.75</b>
4	<b>R4</b>	Swirl 1440°	<b>0.80</b>
	<b>1R4</b>	1 leg Twist 1440°	<b>1.55</b>
	<b>2R4</b>	Twist 1440° (VP)	<b>1.95</b>
	<b>RD4</b>	Two-direction 1440° (VP)	<b>2.15</b>
	<b>RU4</b>	Unbalanced Twist 1440° (VP)	<b>2.35</b>
5	<b>1R5</b>	1 leg Twist 1800°	<b>1.95</b>
	<b>2R5</b>	Twist 1800° (VP)	<b>2.45</b>
	<b>RU5</b>	Unbalanced Twist 1800° (VP)	<b>2.95</b>



6	<b>1R6</b>	1 leg Twist 2160°	<b>2.35</b>
	<b>2R6</b>	Twist 2160° (VP)	<b>2.95</b>
	<b>RD6</b>	Two-direction 2160° (VP)	<b>3.35</b>
	<b>RU6</b>	Unbalanced Twist 2160° (VP)	<b>3.55</b>
7	<b>2R7</b>	Twist 2520° (VP)	<b>3.45</b>
	<b>RU7</b>	Unbalanced Twist 2520° (VP)	<b>4.15</b>
8	<b>2R8</b>	Twist 2880° (VP)	<b>3.95</b>
	<b>RU8</b>	Unbalanced Twist 2880° (VP)	<b>4.75</b>
9	<b>2R9</b>	Twist 3240° (VP)	<b>4.45</b>
	<b>RU9</b>	Unbalanced Twist 3240° (VP)	<b>5.35</b>
10	<b>2R10</b>	Twist 3600° (VP)	<b>4.95</b>
	<b>RU10</b>	Unbalanced Twist 3600° (VP)	<b>5.95</b>

#### **Airborne Weight (A)**

*This family includes movements that require an amount of the body out of the water (single or double legs) and reflect the difficulty of maintaining balanced and unbalanced airborne weight.*

- When "sustained height" is stated, it means airborne weight lasting equal or more than 3 seconds. The duration of execution should be sufficient to clearly identify the difficulty by the technical controllers.
- Please take note of General Principle d) as Airborne Weight may not be declared when occurring simultaneously with a rotation.
- Please see general principles on p.21-22 for definition of unbalanced
- The minimum height required for Airborne Weight is 3.5, meaning starting or finishing positions or sustained actions must meet this standard.
  - For example if doing AB (Lift to any single leg position from Inverted Tuck Table Top or a variant), the single leg position must be at 3.5.

OR

- For example if doing an A5 (Front Pike to VP while rotating 360°), the ending VP must be at 3.5.



- As per general principle g) for Vertical ascent with 1 or 2 legs (A3): A vertical ascent must rise above the knees (kneecaps clearly visible) or not bend at the knees before reaching above the knees (kneecaps clearly visible). Once above knees other movements/declarations can occur

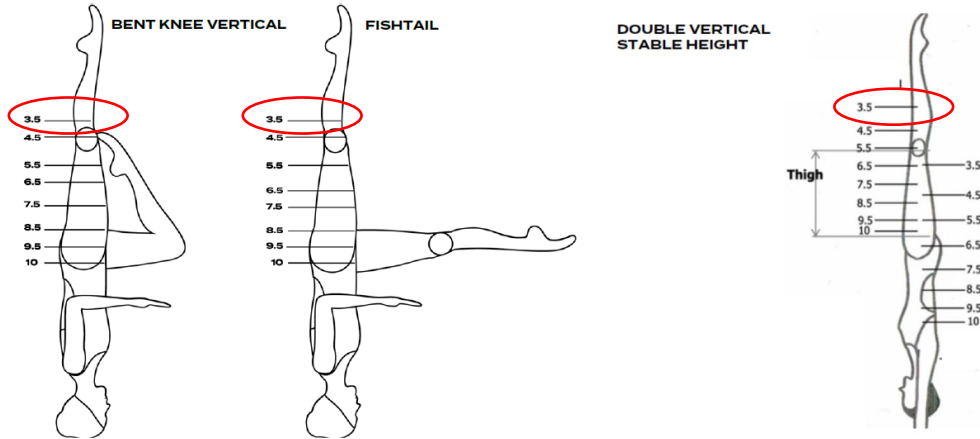

- For movement from Front Pike to VP (Porpoise action): There may be variations in leg movements as long as the integrity of the porpoise lift action is maintained.
  - For example:
    - Legs may be slightly apart (not more than 45 degrees)
    - Legs may be crossed or one slightly bent and one straight, or both slightly bent – as long as still in the “VP Cone” area
- For movements with lifting from Front Pike and rotating:
  - From Front Pike to a single leg position (Bent Knee VP, Fishtail, etc.) while rotating 180o
  - From Front Pike to a single leg position (Bent Knee VP, Fishtail, etc.) while rotating 360o
  - Front Pike to VP while rotating 180o
  - Front Pike to VP while rotating 360

By the halfway point (90°/180°) the legs should not be higher than 45° – meaning the lifting action must be *gradual* (not a lift into the single leg position or VP followed by a twirl 180°/360°)

Level	Code	Description	DD Value
B	<b>AB</b>	Lift to any single leg position from Inverted Tuck Table Top or a variant	<b>0.05</b>
1	<b>A1a</b>	Lift to any single leg position from Front Pike	<b>0.10</b>
	<b>A1b</b>	Single leg descent	
	<b>A1c</b>	Lift to VP from Inverted Tuck, Table Top or a variant	
	<b>A1d</b>	Join to VP from Fishtail, Bent Knee VP or Split	
2	<b>A2a</b>	Vertical descent in VP (with or without isolated movements)	<b>0.15</b>
	<b>A2b</b>	From Front Pike to a single leg position (Bent Knee VP, Fishtail, etc.) while rotating 180°	



3	<b>A3a</b>	Front Pike to VP (Porpoise lift)	<b>0.20</b>
	<b>A3b</b>	Vertical ascent with 1 or 2 legs (with or without isolated movements)	
4	<b>A4a</b>	From Front Pike to a single leg position (Bent Knee VP, Fish-tail, etc.) while rotating 360°	<b>0.45</b>
	<b>A4b</b>	Front Pike to VP while rotating 180°	
5	<b>A5</b>	Front Pike to VP while rotating 360°	<b>0.65</b>
6	<b>A6</b>	<p>Sustained height with one leg or a combination of one or two legs lasting equal or more than 3 seconds</p> <p>Or</p> <p>Isolated movements performed in a stable and fixed single leg position (within VP definition of 0-45 degrees) – isolated movements performed with other (non-fixed) leg lasting 3 seconds or more</p> <p>Or</p> <p>A combination of the two techniques (<i>for example 2 seconds of isolated movements, then 1 second of a combination of one and two leg movements</i>)</p>	<b>1.15</b>
7	<b>A7</b>	Sustained height in VP lasting equal or more than 3 seconds	<b>1.45</b>
8	<b>A8</b>	Sustained height shown at least 3 seconds or more in VP performed in an unbalanced position	<b>1.65</b>

**Flexibility (F)**

This family includes different types of flexibility movements that require an extreme range of suppleness (bring a joint to its maximum range of motion), such as Arches, Splits, Knight, Walkouts, and Nova/Cyclone lift.

- All positions should be shown with maximum strength in legs and a body position with shoulders under the hips that demonstrates the flexibility of the athletes.
- The duration of execution should be sufficient to clearly identify the difficulty by the technical controllers.
- Split position must demonstrate flexibility at the minimum height for split (0.1-2.9 = "scissors") as per the AS Manual or it is subject to a Base Mark.

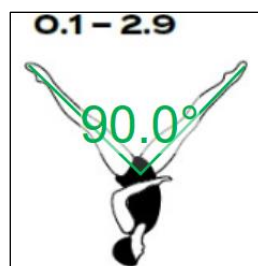





- For Knight position:
  - Minimum height of 6.5 (above knee) is required.
  - The vertical leg can be a maximum of 30 degrees off the vertical line
  - The horizontal leg can't come off the surface more than 30 degrees

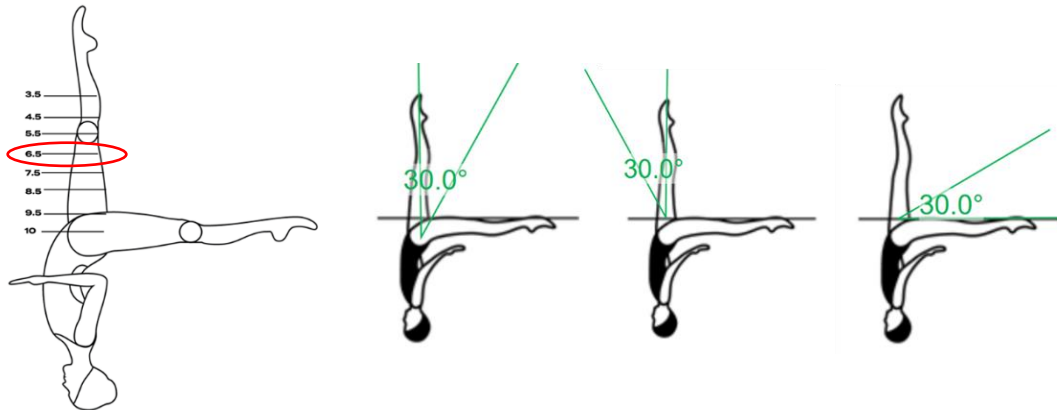

- If declaring Rapid Knight (F1b), you may declare consecutively, however the vertical leg must come out of the VP Cone.
- In regard to Rapid Knight Position or Rapid Split from any position, the action from the starting position to the Knight or Split must be rapid
- Knight join 180°/360° to VP: By the halfway point (90°/180°) the bottom leg should not be higher than 45° – meaning the lifting action must be gradual (not a lift into VP followed by a twirl 180°/360°)
- For F8b: Bent Knee Surface Arch Position to VP rotating 360° (Nova rotating 360°), By the halfway point (180°) the bottom leg should not be higher than 45° – meaning the lifting action must be gradual (not a lift into VP followed by a twirl 360°)
- For movement from Surface Arch to VP:
 

There may be variations in leg movements as long as the integrity of the lift action is maintained

  - For example:
    - Legs may be slightly apart (not more than 45 degrees)
    - Legs may be crossed or one slightly bent and one straight
    - Both legs may not be bent intentionally – slight bending (soft knees) due to bad execution should not be Base Marked.

- Flat Split (F6) as per Height Chart 8.5 level:

<b>8.5</b>	170° - 180°			Legs dry
------------	-------------	--	--	----------



Level	Code	Description	DD Value
B	<b>FB</b>	Back Layout to Surface Arch or Bent Knee Surface Arch	<b>0.05</b>
1	<b>F1a</b>	Rapid Split from any position	<b>0.10</b>
	<b>F1b</b>	Rapid Knight Position	
	<b>F1c</b>	BK Surface Arch to Knight (extending the BK up to Knight)	
2	<b>F2a</b>	Walkout Front (to breath)	<b>0.20</b>
	<b>F2b</b>	Split to Front Pike (180° arc with a straight leg)	
	<b>F2c</b>	Split variants at the surface (demonstration of at least 2 different Splits)	
3	<b>F3a</b>	Split to Split through VP (changing legs)	<b>0.30</b>
	<b>F3b</b>	Ariana Rotation	
	<b>F3c</b>	Combination of a Right and Left Leg Knight Position	
4	<b>F4a</b>	Bent Knee Front Layout to Bent Knee Arch Position OR Front Layout to Split with a straight leg	<b>0.40</b>
	<b>F4b</b>	From Surface Arch Position to Knight or Split with a straight leg	
	<b>F4c</b>	Bent Knee Surface Arch to Bent Knee VP	
	<b>F4d</b>	BK Surface Arch to Knight (lifting the extended leg to VP and extending the bent leg horizontally on the surface)	
	<b>F4e</b>	Fishtail to Knight (horizontal plane, along the surface)	
	<b>F4f</b>	Fishtail to Knight (through VP)	
5	<b>F5a</b>	Knight to VP OR Knight to Fishtail through VP	<b>0.50</b>
	<b>F5b</b>	Bent Knee Surface Arch to VP	
	<b>F5c</b>	Knight rotating 180° (twisting in the Knight position)	
6	<b>F6a</b>	Cyclone 180° (BK Surface Arch Twirl 180° to a VP)	<b>0.65</b>
	<b>F6b</b>	Knight rotating 360° (twisting in the Knight position)	
	<b>F6c</b>	Knight Join to VP while rotating 180°	
	<b>F6d</b>	Flat Split or Split variants sustained at the surface 3 seconds or more (split variants may not bend knees more than 90° or lift the thigh past 45° while transitioning from one split to another)	



7	<b>F7</b>	Surface Arch to VP	<b>0.75</b>
8	<b>F8a</b>	Knight Join to VP while rotating 360°	<b>0.90</b>
	<b>F8b</b>	Bent Knee Surface Arch Position to VP rotating 360° (Nova rotating 360°)	
9	<b>F9</b>	Surface Arch Position to VP rotating 180°	<b>1.00</b>
10	<b>F10</b>	Surface Arch Position to VP rotating 360°	<b>1.30</b>

**Connections (C)**

*This family includes movements when swimmers join or link together with their legs creating a connected action.*

- The swimmers must be touching with 1-2 legs in the manner detailed in the table. An exception shall be wrapping a leg around the body (CB and C1 levels).

- Connected Actions in Teams (Connections of 4-10 athletes):

This means groupings of 4-10 athletes are connected - for example 2 lines of 4-5 athletes, 1 line of 8-10 athletes, a circle of 8-10 athletes or circles of 4-5 athletes

For these connected actions of 4-10 athletes 0.10 will be added to the declared connection

Connected actions for groupings of 4-10 athletes will have a plus symbol (+) added to the codes

- When two of the SAME connections are performed consecutively (one after the other), then they must be separated by a disconnection OR the *connected legs* coming out of the VP "cone" area

For example, if declaring C2 C2, then the athletes must connect, disconnect/or come out of VP "cone", then connect again:



- When two DIFFERENT connections are performed consecutively (one after the other) then they may be performed one after the other without a disconnection or coming out of the VP "cone" area

For example, if declaring C4 C3, then the athletes may demonstrate a C4 connection, immediately followed by a C3 connection:

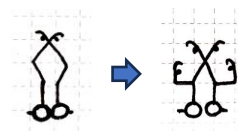



- For connections with a rotation of at least 180° or 360° at sustained height:

Rotations in the connections family must have the athletes rotate around (change of position), be a "rotation of the construction" and NOT just a pivot of the hips (like a RD1)

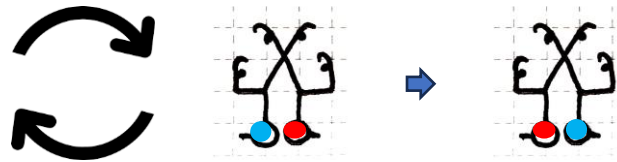

Connected rotations must be completed at a sustained height – the rotation may not begin while ascending or end while descending. A drop of two height levels during the rotation would be subject to Base Mark.

- For example, a duet may rise connected in a two leg connection and claim an A3, THEN once the ascent is complete, they can then turn 180° for the C6a
- Please beware an ascent (A2 or A3) can't be declared simultaneously with a connection. The ascent must be completed first (rise above the knee) and then the connection must occur as a separate movement.
- Please see the following table for example images of descriptions of connections

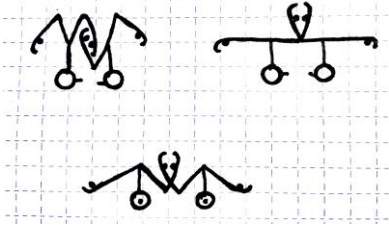
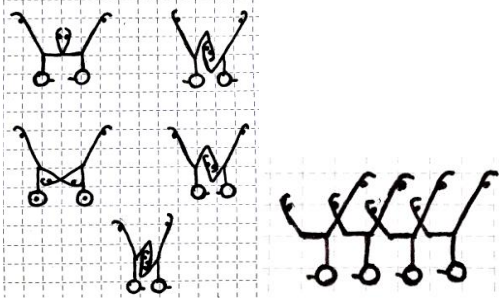
Level	Description	Code	DD Value
B	<p>Piked body position at the surface of the water or any position out of VP "cone" area (facing any direction)</p> <p>Connections are on the surface of the water without lifting the feet from the water OR any position out of VP "cone" area (facing any direction) OR wrapping a leg around the body (pelvis).</p> 	<b>CB</b> <b>2-3 connected</b>	<b>0.10</b>
		<b>CB+</b> <b>4-5, 8-10 connected</b>	<b>0.20</b>
1	<p>C1a: Connection in any one leg VP position (in "cone" area) with the "bottom" leg (non-VP leg) connected. Can be facing any direction</p> <p>C1b: Connecting a bottom leg with a thigh of VP leg (athletes facing same direction) OR wrapping a leg around the body (pelvis) – can be facing any direction.</p> 	<b>C1a</b> <b>C1b</b> <b>2-3 connected</b>	<b>0.20</b>
		<b>C1a+</b> <b>C1b+</b> <b>4-5, 8-10 connected</b>	<b>0.30</b>

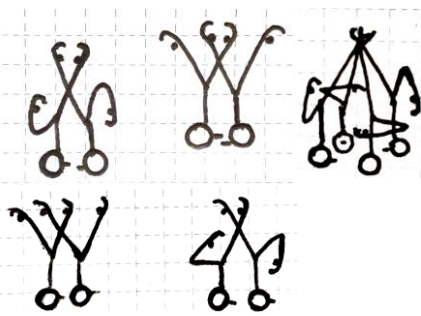
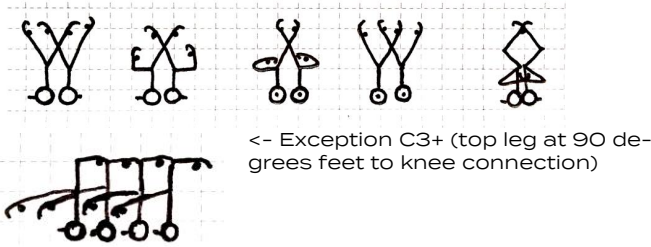
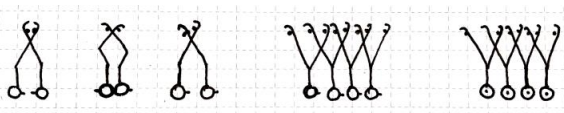

2	<p>C2a: One leg (in VP "cone" area) face-to-face connection</p> <p>C2b: One leg back (in VP "cone") one leg forward (in VP "cone") connection</p> <p>In C2a or C2b swimmers connect in any one or two leg Vertical Position and make a clear connection with one vertical ("top") leg.</p> <p>C2c: C1 connections with a rotation of at least 180° at sustained height</p>	<p><b>C2a C2b C2c</b></p> <p><b>2-3 connected</b></p>	<b>0.30</b>
		<p><b>C2a+ C2b+ C2c+</b></p> <p><b>4-5, 8-10 connected</b></p>	<b>0.40</b>
3	<p>One leg (in VP "cone" area) <u>back</u> or <u>side</u> connection</p> <p>Swimmers are connected in any one or two leg Vertical Position with one leg back or to the side of each other and make a clear connection with one vertical ("top") leg.</p>	<p><b>C3</b></p> <p><b>2-3 connected</b></p>	<b>0.40</b>
	 <p>&lt;- Exception C3+ (top leg at 90 degrees feet to knee connection)</p>	<p><b>C3+</b></p> <p><b>4-5, 8-10 connected</b></p>	<b>0.50</b>
4	<p>Two-leg connection (both legs must be in VP "cone" area). May be facing any direction.</p> <p>Swimmers are connected with two legs facing ANY direction in any two-leg Vertical Position (variants of 2 legs close to vertical – legs can be up to 45° off from vertical).</p>	<p><b>C4</b></p> <p><b>2-3 connected</b></p>	<b>0.50</b>
		<p><b>C4+</b></p> <p><b>4-5, 8-10 connected</b></p>	<b>0.60</b>
5	<p>Rotation vertical connection with one leg in VP "cone" area (Rotation of 180°+ at maximum height). May be facing any direction.</p> <p>When swimmers are connected with ONE LEG, which could be executed in a one or two leg vertical position. Facing any direction, athletes make a clear connection with one vertical (top) leg while performing a rotation of at least 180° at sustained height.</p>	<p><b>C5</b></p> <p><b>2-3 connected</b></p>	<b>1.00</b>
		<p><b>C5+</b></p> <p><b>4-5, 8-10 connected</b></p>	<b>1.10</b>



6	<p>C6a: Rotation vertical connection with two legs in VP "cone" area (rotation of 180°+ at maximum height). May be facing any direction.</p> <p>When swimmers are connected with TWO LEGS facing ANY direction in any two-leg Vertical Position (variants of 2 legs close to vertical – legs can be up to 45° off from vertical), while performing a rotation of at least 180° at sustained height.</p> <p>C6b: Rotation vertical connection with one leg (rotation of 360°+ at maximum height. May be facing any direction. C5 definition with rotation of 360° or more at sustained height.</p>	<p><b>C6a C6b</b></p> <p><b>2-3 connected</b></p>	<b>1.25</b>
		<p><b>C6a+ C6b+</b></p> <p><b>4-5, 8-10 connected</b></p>	<b>1.35</b>
7	<p>360° Rotation vertical connection with two legs in VP "cone" area (rotation of 360°+ at maximum height). May be facing any direction. C6a definition with rotation of 360° or more at sustained height.</p>	<p><b>C7</b></p> <p><b>2-3 connected</b></p>	<b>1.50</b>
		<p><b>C7+</b></p> <p><b>4-5, 8-10 connected</b></p>	<b>1.60</b>

## 29.6.2 Bonuses

### Pattern Changes (PC)

This bonus is applied for Teams only for changes of formations made by the spatial relationship between members of a team.

Team Tech, Team Free and Free Combination routines shall include a bonus for each Pattern Change executed valued at 0.20 each

Each pattern change in a hybrid is counted. For example, if a hybrid has 3 pattern changes the code would be 3PC in the bonus section of the Coach Card.

### IMPORTANT NOTES REGARDING TC VERIFICATION OF PATTERN CHANGES:

- Traveling of all athletes in the same direction while maintaining the pattern is not a pattern change.
- When pattern changes are 'transitional' – passing through from one to another – the pattern change must pause and *clearly demonstrate the new pattern* before continuing.
- If a team declares a pattern change, the DTC's do need to see that the change was clearly attempted. They do not judge execution of the pattern change or new pattern, but they do need to clearly see that that a new pattern was created.
- If there is a lack of clarity in the pattern changes declared, meaning change to a new pattern is *not recognizable*, this will result in a Base Mark.



Further notes:

- o If from the Rhombus/Diamond  $\blacklozenge$  a change to a circle  $\bigcirc$  is executed – this is Ok – the DTCs should not see the points for the Rhombus/Diamond.

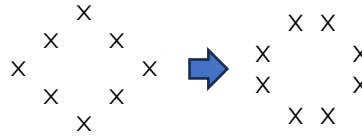

- o If a rotation on themselves in Rhombus/Diamond  $\blacklozenge$  (remaining in a Rhombus/Diamond) then it is not a pattern change.

HYBRID DIFFICULTY TABLE:

**Please see the end of the guide for printable Hybrid Difficulty Table**

**Important: Most up-to-date version is October 2024**

### 29.6.3 General Principles

- a) When Vertical Position (VP) is indicated it includes variants of 2 legs at or close to vertical (legs can be up to 45° off from vertical). One leg Vertical Positions such as Bent Knee, Crane, or Fishtail can also be up to 45° off vertical line. Knight position is as per Flexibility family (max 30° off top or bottom leg).

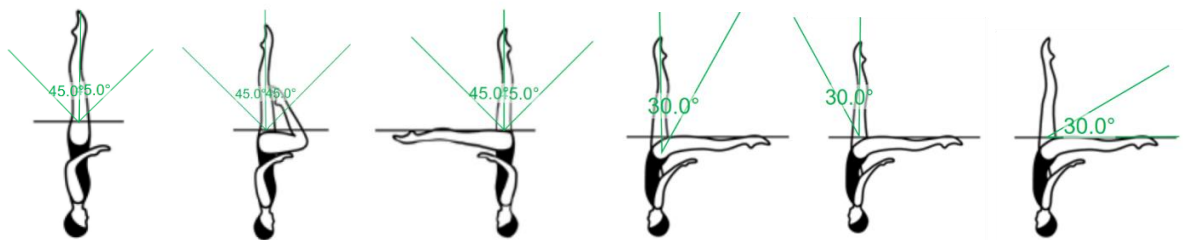

- b) Each Free Routine (Senior, Junior, Youth, 12U) MUST include a skill from every family (except for Connections in Solo). All routine members must perform that skill in the same declaration on the coach card (not factored).
- c) Example: The skill is a Thrust Level 3a (Thrust and vertical descent). A T3a is declared on the coach card. It could be done all 8 together (fully synchronized), or as a cadence action; for example, 4 and then 4, or 3/3/2 or 2/2/2/2, or one at a time.
- d) There is a maximum of 5 declarations per family per hybrid, with a limit of 3x per technique. For example, you may do 5x "R" family declarations but a maximum of 3 specific techniques (ie 2R1 x 3 and R01 x 2).



- e) When two movements from different families in the difficulty table *occur simultaneously* then you may only declare one. Examples:

If a VP open to Split 360° (RO1) is being executed, then you may not also declare F1 (Rapid Split from any position).

If a SB (Spin 180°) is declared performed as a spin ascending, then an A3 (vertical ascent) can't be declared simultaneously

If a RU5 (Unbalanced Twist 1800) is declared and it takes 3s+ then an A8 can't be declared simultaneously.

- f) In teams or duet: when a **code (technique)** is not performed by all team or duet members its value will be factored by \*0.5 (half of swimmers included), or by \*0.3 (less than half of swimmers included). This principle also applies in duet actions where just one swimmer is performing a hybrid movement while the other performs surface accompaniment (whether connected or not).

When a code (for example when 3x maximum per technique is being used) has a factor applied of 0.5 (half swimmers) or 0.3 (less than half of swimmers) a coach may declare that movement a maximum of 6x in one hybrid when factored.

Factoring *does not apply* to the pattern change bonus.

Factoring can only be used when different codes/techniques are being executed by the athletes. If all athletes are doing the same choreography (same code/technique) factoring can't be used.

- g) When a cadence is performed *you just declare the full code once* on the Coach Card. Difficulty Guide General Principle e) does not apply (factoring). Meaning – when the whole team does the same “cadence” movement sequentially/ consecutively (one after the other – 1 at a time, 2 at time, 4/4/2, 4/4, etc.), you just put the difficulty code once. For example, if all 8 athletes on a team do a S1 (spin descending/ascending 360°) one at a time – just declare S1 once on the Coach Card.

- h) In Thrust Level 9 (Thrust continued by catching – clearly stopping – stable height demonstrated for 1 second or more) in a Vertical Position above the knees or higher), we use the knees as a reference point for verification of accomplishing the movement. Knees as a reference point for difficulty verification will also be applied to other movements as follows with ascending or descending actions:

- For a Thrust and vertical descent
  - If a descent is executed from maximum height until below the knee (kneecaps submerged) and then a crash occurs, this still applies as an accomplished descent.
- For Vertical descent (one or two legs – A1 or A2)
  - If a descent is executed from a high VP (9.5–8.5) until below the knee (kneecaps submerged) and then a crash occurs, then an A1 or A2 still applies.
- For Vertical ascent with 1 or 2 legs (A3)
  - A vertical ascent must rise above the knees (kneecaps clearly visible) or not bend at the knees before reaching above the knees (kneecaps clearly visible). Once above knees other movements/declarations can occur.

- i) When unbalanced is stated it means both legs from thighs to feet, in the same direction: forwards, backwards, or sideways (Body position arched, piked, or tilted) clearly OFF the vertical line, and clearly ABOVE (off) the surface of the water.

If technology is available at a competition where athletes can be measured for compliance **15–45 degrees** off VP is the required angle to be achieved **0–15 degrees** is *too straight* and therefore not unbalanced, and *lower than 45 degrees* is out of the VP definition.





For Technical Controllers without technology – if an athlete is completely straight during a declared unbalanced action that is subject to a Base Mark. If an athlete is clearly lower than 45 degrees and near the surface of the water that is subject to a Base Mark.

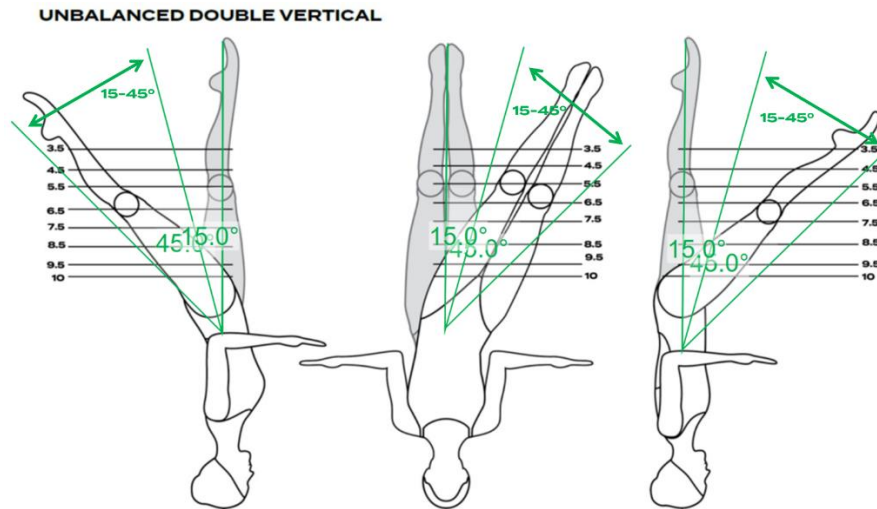

If one leg bends while the other leg is unbalanced and the swimmer's centre of gravity out of the vertical line is compensated by the knee bending that keeps the swimmer in a stable position – this does not qualify as unbalanced.



**29.6.5 Important – Regarding declared difficulty movements / Coach Card**

It is very important that athletes perform skills (codes/techniques) as declared on the Coach Card AND in the order in which they are declared – otherwise a deduction will occur. We strongly advise “Do what you declare!”

If the coach has declared a movement on the Coach Card and an athlete does not perform it at all (it is omitted), or does not perform it in conformance to what is declared on the Coach Card (code/technique is different or in wrong order than declared) then the following shall occur:

**For a Free Hybrid:**

- Only the Base Mark (value of 0.5) will be applied
  - For example, a routine hybrid is declared to have:
  - Thrust Level 3 (T3), Airborne Weight Level 3 (A3), and a Spin Level 4 (S4),
  - However, an athlete does not perform their Spin Level 4 (for example a spin descending 1440o) and instead does a S3 (spin descending 1080o)
  - The routine will have this hybrid put to Base Mark (value of 0.5).
  - Please note in duet or team if ONE athlete does not perform movement as declared the deduction will apply
- The hybrid declaration must be in the exact order that it appears in the hybrid chronologically – as above – First a T3, then A3, then S4 occurs. IF this is incorrectly ordered on Coach Card vs what is done in the water, the deduction will apply.

**For a Technical Required Element:**

- In technical routines, a Technical Required Element (TRE) will be declared as TRE1a or TRE1b, TRE2a or TRE2b, TRE3a or TRE3b, TRE4a or TRE4b, and TRE5a or TRE5b (note: in disciplines where there is only one option for an element no letter is included when declared on the Coach Card – for example “TRE3”)
- Required Elements can be performed in any order however, athletes must perform the Technical Required Elements in the order as declared on the Coach Card or a penalty will be applied as per the rulebook.
- Please also note that additional movements can be added immediately before and after (breath to breath) Technical Required Element. Those movements will not add any extra difficulty nor will be considered as additional hybrids and therefore are not to be added to the Coach Card.

**For an Acrobatic movement (Teams and Duets):**

- Acrobatic codes should be added to the Coach Card as per the Acrobatic Catalogues
- A Base Mark will be applied to acrobatics not performed in conformance to what is declared on the Coach Card.
- Please refer to the Acrobatic Catalogue for Acrobatic Base Marks

**29.6.6 Coach Card Legend**
**Acrobatics Base Mark:**

Group A	ACRO-A	For Acrobatics, please enter the acrobatic code in the "declared difficulty" column as per the Acrobatics Catalogue.
Group B	ACRO-B	
Group C	ACRO-C	
Group P	ACRO-P	
Pair Acro	Acro-Pair	

*\*\*Please refer to the Acrobatics Catalogue for Acrobatic codes and Acro Base Marks.*

**Hybrid Base Mark:**

Hybrid Base Mark is fixed at 0.5 and is added to the value of the hybrid DD, and it is the value (0.5) the hybrid will go to if not successful in achieving the declared difficulty.

**Hybrid Families and Bonuses:**

Families (groups)/Bonuses:		Family and Level Codes:
Thrusts	T	TB, T1-T9
Spins:		
Spins – ascending/descending	S	SB, S1-S10
Spins – combined	SC	SCB, SC1-SC6
Spins – combined two-direction	SCD	SCDB, SCD1-SCD6
Twists (Incl. Twirls and Swirls)		RB, R1-R9
Swirl	R	RB, R1-R4
One leg Twists	1R	1RB, 1R1-1R6
Two leg Twists	2R	2RB, 2R1-2R10
Two-direction Twist	RD	RD1-RD6
Unbalanced Twist	RU	RU1-RU10
VP to Split	RO	ROB, RO1
Split to VP	RC	RCB, RC1
Flexibility	F	FB, F1-F10
Airborne Weight	A	AB, A1-A8
Connections		
Connections (2-3 athletes)	C	CB, C1-C7
Connections (4-5, 8-10 athletes)	C+	CB+, C1+-C7+
Pattern Changes	PC	1PC, 2PC, etc . . .
<i>In Thrusts, Airborne Weight, Flexibility and Connections where are few skills are grouped together in a level, each technique has been labelled as a, b, c, d, e or f to ensure clarity or what is being declared.</i>		

**Technical Required Elements:**

Element 1	Element 2	Element 3	Element 4	Element 5
TRE1a	TRE2a	TRE3a	TRE4a	TRE5a
TRE1b	TRE2b	TRE3b	TRE4b	TRE5b

**\*Note:** in disciplines where there is only one option for an element, no letter is included – for example “TRE3”

**29.6.7 Coach Card Auto Calculator**

A Difficulty Calculator designed like a Coach Card format has been developed into an Excel Template Tool and is available for coaches to use and modify to suit their needs to assist in strategizing their routine difficulty. This is a tool and resource for coaches and is not meant to be used for competition submission. Get familiar with it and make it your own, always adhering to values as per the current Hybrid Difficulty Table and Acrobatic Catalogues. Updates to the calculator will be made as needed to stay up to date with any revised values.

The user can enter movement codes to calculate the difficulty for hybrids, as well as add in Technical Required Element codes. Please refer to the “LEGEND” tab in the spreadsheet for all codes (this is important). When a code is entered the value will appear automatically in the cell below the code. Acrobatic values are based on the Acrobatics Catalogues and must be added manually. The user can also add all values in manually if preferred.

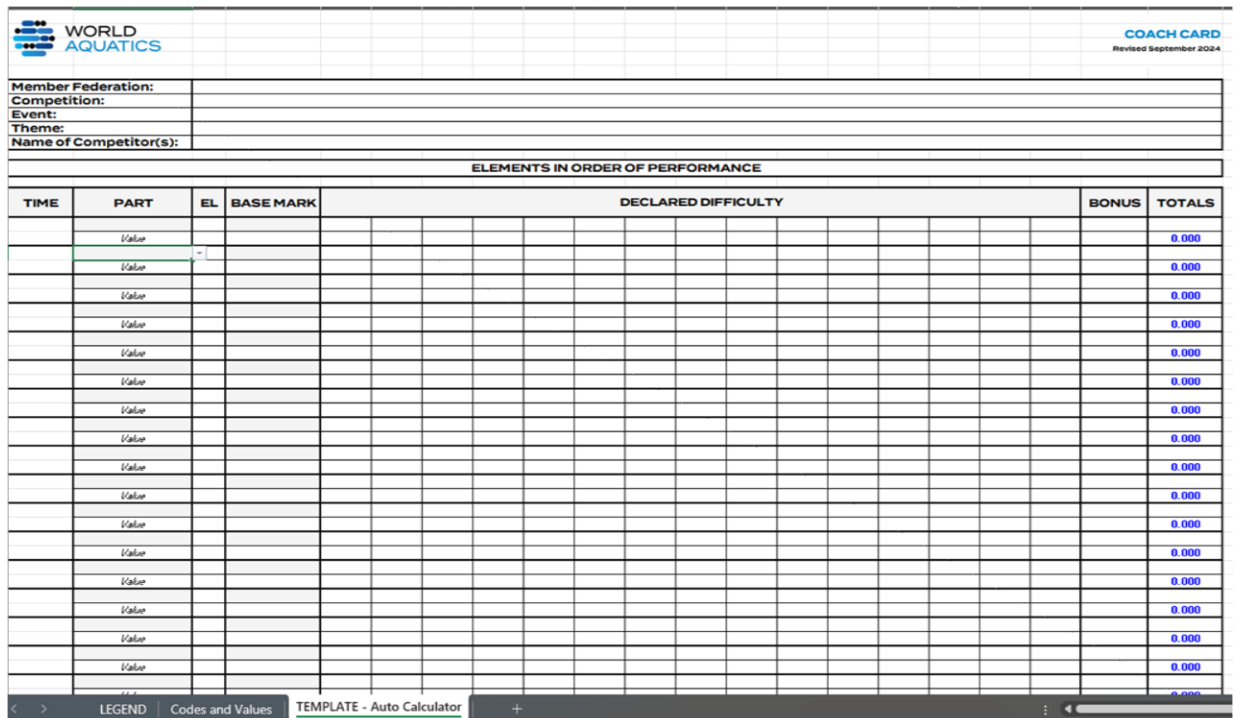



### 29.6.8 Hybrid Difficulty Table

#### Important Notes:

- All hybrids shall start with a base value or “Base Mark” of **0.50** and then start adding difficulty from that base value
- Each **Free Routine** (Senior, Junior, Youth, 12U) MUST include a skill from every family (except for Connections in Solo). All routine members must perform that skill in the same declaration on the coach card (not factored).
  - Example: The skill is a Thrust Level 3a (Thrust and vertical descent). A T3a is declared on the coach card. It could be done all 8 together (fully synchronized), or as a cadence action; for example, 4 and then 4, or 3/3/2 or 2/2/2/2, or one at a time.
- There is a maximum of **5 declarations per family per hybrid, with a limit of 3x per technique**
  - In Spins (S) or Twists (R), you may do 5x “S” family and 5 x “R” family declarations per hybrid but a maximum of 3 specific techniques. Each Spin (S) or Twist (R) code on the table represents a specific technique.
    - For example, for Twists you could declare: 2R1 x 3 and R01 x 2
  - In other families (Thrusts, Airborne Weight, Flexibility and Connections) where a few skills are grouped together in a level, each technique has now been labelled as **a, b, c, d, e, or f** to ensure clarity of what is being declared (for example in Flexibility Level 1 you will now see: F1a, F1b and F1c).
    - For example, for Flexibility you could declare: 1 x F7, 3 x F5a, and 1 x F1a
- **Thrust family:**
  - Whenever “Thrust” is stated it means two legs, otherwise one leg is stated.
- **Spin family:**
  - Spins for ascending and descending are not differentiated, for example an S1 (spin 360 with one or two legs) may be ascending or descending.
  - When “Combined” is stated, it means a Combined (descending then ascending) or Reverse Combined (ascending then descending) Spin
- Team Tech, Team Free and Free Combination routines shall include a bonus for each Pattern Change executed valued at **0.20** each



L	THRUSTS (T)	SPINS (S)	TWISTS incl. Twirls/Swirls (R)	AIRBORNE WEIGHT (A)	FLEXIBILITY (F)	CONNECTIONS (C)
<b>(B)</b> <b>A</b> <b>S</b> <b>I</b> <b>C</b>	Thrust with one or two legs followed by crashing on the surface	<b>SB = 0.15</b> <b>SCB = 0.35</b> <b>SCDB = 0.40</b>	Spin 180° (one or two legs) Combined 180° (one or two legs) Two-direction Combined 180° (one or two legs)	Lift to any single leg position from Inverted Tuck, Table Top or a variant	Back Layout to Surface Arch or Bent Knee Surface Arch	Piked body position at the surface of the water or any position out of VP "cone" area (facing any direction)
	<b>TB = 0.30</b>			<b>AB = 0.05</b>	<b>FB = 0.05</b>	<b>CB = 0.10</b> <b>CB+ = 0.20</b>
<b>1</b>	Thrust with one leg followed by vertical descent	<b>S1 = 0.35</b> <b>SC1 = 0.80</b> <b>SCD1 = 0.85</b>	Swirl 360°/Rotation 360° non-sustained or up-down 1 leg Twirl/Twirl 180° Twirl/Twirl 180° (VP) VP open 180° to Split Split close 180° to VP	Lift to any single leg position from Front Pike Single leg descent Lift to VP from Inverted Tuck, Table Top or a variant Join to VP from Fishtail, Bent Knee VP or Split	<b>a.</b> Rapid Split from any position <b>b.</b> Rapid Knight Position <b>c.</b> BK Surface Arch to Knight (extending the BK up to Knight)	<b>a.</b> Connection in any one leg VP position (in "cone" area) with the "bottom" leg (non-VP leg) connected. Can be facing any direction. <b>b.</b> Connecting a bottom leg with a thigh of VP leg (athletes facing same direction) OR wrapping a leg around the body (pelvis) – can be facing any direction.
	<b>T1 = 0.45</b>		<b>R1 = 0.20</b> <b>1R1 = 0.35</b> <b>2R1 = 0.45</b> <b>RD1 = 0.50</b> <b>RU1 = 0.55</b> <b>RO1 = 0.55</b> <b>RC1 = 0.55</b>	<b>A1 = 0.10</b>	<b>F1 = 0.10</b>	<b>C1 = 0.20</b> <b>C1+ = 0.30</b>
<b>2</b>	<b>a.</b> Thrust with one leg followed by Spin 180°	<b>S2 = 0.75</b> <b>SC2 = 1.60</b> <b>SCD2 = 1.65</b>	Swirl 720° (one or two legs) Combined 720° (one or two legs) Two-direction Combined 720° (one or two legs)	Vertical descent in VP (with or without isolated movements) From Front Pike to a single leg position (Bent Knee VP, Fishtail, etc.) while rotating 180°	<b>a.</b> Walkout Front (to breath) <b>b.</b> Split to Front Pike (180° arc with straight leg) <b>c.</b> Split variants at the surface (demonstration of at least 2 different Splits)	<b>a.</b> One leg (in VP "cone" area) face-to-face connection <b>b.</b> One leg back (in VP "cone"), one leg forward (in VP cone) connection <b>c.</b> C1 connections with a rotation of at least 180° at maximum height
	<b>b.</b> Thrust with one leg followed by Twirl 180° and a crash					
	<b>T2 = 0.50</b>	<b>RU2 = 1.15</b>	Unbalanced Twirl 720° (VP)	<b>A2 = 0.15</b>	<b>F2 = 0.20</b>	<b>C2 = 0.30</b> <b>C2+ = 0.40</b>



L	THRUSTS (T)	SPINS (S)	TWISTS incl. Twists/Swirls (R)	AIRBORNE WEIGHT (A)	FLEXIBILITY (F)	CONNECTIONS (C)
3	a. Thrust and vertical descent	<b>S3 = 1.15</b>  <b>SC3 = 2.40</b>  <b>SCD3 = 2.45</b>	Swirl 1080°  1 leg Twist 1080°  Twist 1080° (VP)  Unbalanced Twist 1080° (VP)	a. Front Pike to VP (Porpoise lift)  b. Vertical ascent with 1 or 2 legs (with or without isolated movements)	a. Split to Split through VP (changing legs)  b. Ariana Rotation  c. Combination of a Right and Left Leg Knight Position	One leg (in VP "cone" area) back or side connection
	b. Thrust with one leg followed by Spin 360°					
4	c. Thrust with one leg followed by Twirl 180° and descent	<b>S4 = 1.55</b>  <b>SC4 = 3.20</b>  <b>SCD4 = 3.25</b>	Swirl 1440°  1 leg Twist 1440°  Twist 1440° (VP)  Two-direction 1440° (VP)  Unbalanced Twist 1440° (VP)	a. From Front Pike to a single leg position (Bent Knee VP, Fishtail, etc.) while rotating 360°  b. Front Pike to VP while rotating 180°	a. Bent Knee Front Layout to Bent Knee Arch Position OR Front Layout to Split with a straight leg  b. From Surface to Arch Position to Knight or Split with a straight leg  c. Bent Knee Surface Arch to Bent Knee VP  d. BK Surface Arch to Knight (lifting the extended leg and extending on the surface the bent leg)  e. Fishtail to Knight (horizontal plane, along the surface)  f. Fishtail to Knight (through VP)	Two-leg connection (both legs must be in VP "cone" area). May be facing any direction.
	d. Thrust with flexibility and descent					
	e. Thrust followed by Twirl 180° and a crash	<b>T4 = 0.80</b>				





L	THRUSTS (T)	SPINS (S)	TWISTS Incl. Twirls/Swirls (R)	AIRBORNE WEIGHT (A)	FLEXIBILITY (F)	CONNECTIONS (C)
5	a. Thrust followed by Spin 360°	<b>SS = 1.95</b>	1 leg Twist 1800°	Front Pike to VP while rotating 360°	a. Knight to VP OR Knight to Fishtail through VP b. Bent Knee Surface Arch to VP c. Knight rotating 180° (twisting in the Knight position)	Rotation vertical connection with one leg in VP "cone" area (rotation of 180°+ at maximum height). May be facing any direction.
	b. Thrust followed by Twirl 180° and descent	<b>SCS = 4.00</b>	Twist 1800° (VP)			
	c. Thrust with flexibility followed by Spin 180°	<b>SCD5 = 4.05</b>	Unbalanced Twist 1800° (VP)			
	d. Flying Fish Spin 180° or Thrust					
	e. One leg Thrust with Twirl 180° followed by Spin 360°					
	<b>T5 = 0.90</b>			<b>A5 = 0.65</b>	<b>F5 = 0.50</b>	<b>C5 = 1.00</b> <b>C5+ = 1.10</b>
6	a. Thrust with flexibility followed by Spin 360°	<b>S6 = 2.35</b>	1 leg Twist 2160°	Sustained height with one leg or a combination of one or two legs lasting equal or more than 3 seconds Or Isolated movements performed in a stable and fixed single leg position (within VP definition of 0-45 degrees) – isolated movements performed with other (non-fixed) leg lasting 3 seconds or more Or A combination of the two techniques	a. Cyclone 180° (BK Surface Arch Twirl 180° to a VP) b. Knight rotating 360° (twisting in the Knight position) c. Knight Join to VP while rotating 180° d. Flat Split/Split variants sustained at the surface 3 seconds or more	Rotation vertical connection with two legs in VP "cone" area (rotation of 180°+ at maximum height). May be facing any direction.  Rotation vertical connection with one leg (rotation of 360°+ at maximum height). May be facing any direction.
	b. Thrust with Twirl 180° followed by Spin 360°	<b>SC6 = 4.80</b>	Twist 2160° (VP)			
	c. Flying Fish 360° or Thrust Fishtail Helicopter Spinning 360°	<b>SCD6 = 4.85</b>	Two-direction 2160° (VP)			
	<b>T6 = 1.10</b>		Unbalanced Twist 2160° (VP)	<b>A6 = 1.15</b>	<b>F6 = 0.65</b>	<b>C6 = 1.25</b> <b>C6+ = 1.35</b>



<b>L</b>	<b>THRUSTS (T)</b>	<b>SPINS (S)</b>	<b>TWISTS Incl. Twists/Swirls (R)</b>	<b>AIRBORNE WEIGHT (A)</b>	<b>FLEXIBILITY (F)</b>	<b>CONNECTIONS (C)</b>
<b>7</b>	Thrust followed by Spin 720°	Spin 2520° (two legs) <b>S7 = 2.75</b>	Twist 2520° (VP) <b>2R7 = 3.45</b> Unbalanced Twist 2520° (VP) <b>RU7 = 4.15</b>	Sustained height in VP lasting equal or more than 3 seconds <b>A7 = 1.45</b>	Surface Arch to VP	Rotation vertical connection with two legs in VP "cone" area (rotation of 360°+ at maximum height). May be facing any direction. <b>C7 = 1.50</b> <b>C7+ = 1.60</b>
	<b>T7 = 1.50</b>					
<b>8</b>	Thrust with flexibility followed by Spin 720°	Spin 2880° (two legs) <b>S8 = 3.15</b>	Twist 2880° (VP) <b>2R8 = 3.95</b> Unbalanced Twist 2880° (VP) <b>RU8 = 4.75</b>	Sustained height shown at least 3 seconds or more in VP performed in an unbalanced position <b>A8 = 1.65</b>	a. Knight Join to VP while rotating 360° b. Bent Knee Surface Arch Position to VP rotating 360° (Nova rotating 360°)  <b>F7 = 0.75</b> <b>F8 = 0.90</b>	
	<b>T8 = 1.70</b>					
<b>9</b>	a. Thrust to height of 8.5 (waist) or higher followed by Spin 1080° or more b. Thrust to height of 8.5 (waist) or higher continued by catching (clearly stopping - stable height demonstrated for 1s or more) in a VP above the knees or higher  <b>T9 = 2.00</b>	Spin 3240° (two legs) <b>S9 = 3.55</b>	Twist 3240° (VP) <b>2R9 = 4.45</b> Unbalanced Twist 3240° (VP) <b>RU9 = 5.35</b>		Surface Arch Position to VP rotating 180°	
	<b>F9 = 1.00</b>					
<b>10</b>		Spin 3600° (two legs) <b>S10 = 3.95</b>	Twist 3600° (VP) <b>2R10 = 4.95</b> Unbalanced Twist 3600° (VP) <b>RU10 = 5.95</b>		Surface Arch Position to VP rotating 360° <b>F10 = 1.30</b>	

**29.7 APPENDIX 7 - ACROBATICS CATALOGUE**
**29.7.1 Team Acrobatics Catalogue**
**29.7.1.1 Classification of Acrobatic Movements, Groups, and Terminology**
**Important Terminology**

- Acrobatic movement:** General term for jumps, throws, lifts, stacks, platforms, etc., which is an integral part of artistic swimming routines that demonstrate spectacular gymnastic feats and/or risky actions in the air, on a balancing support, or in combination, and are achieved with the assistance of other swimmers. A team acrobatic movement is considered as an Element, starting from 4 swimmers and more (for example: 3 base-swimmers + 1 featured-swimmer; or 2 base-swimmers + 1 support-swimmer who pushes 1 featured-swimmer). They must start and finish in the water! Acrobatic actions involving 3 swimmers or less are considered as pair acrobatics or pair assisted actions.
- For example: these will not be considered as acrobatic movement

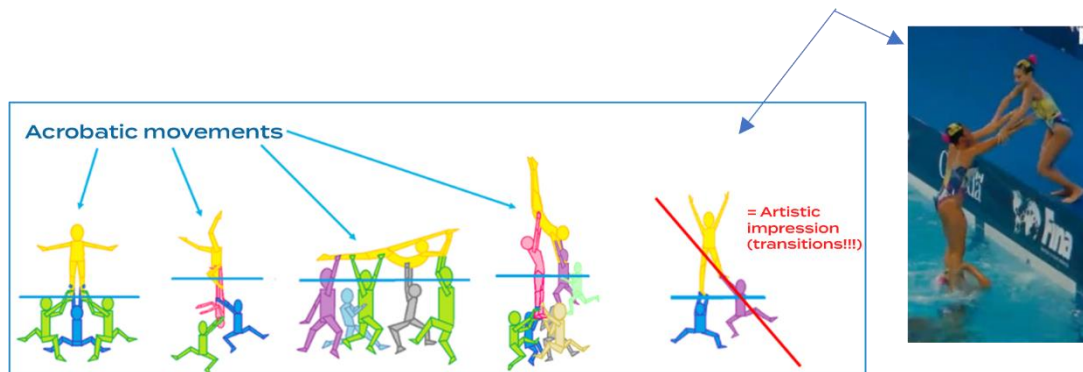

- Base-swimmer:** role of swimmer consists of pushing/lifting the featured-swimmer/s or the support-swimmer/s with the featured-swimmer on top.
- Support-swimmer (middle):** swimmer working or maintaining position on top of the base-swimmer(s) in a "three tier/level" construction. Example: stack, standard platform, and "Sq" construction in group A.
- Featured-swimmer (flyer or featured performer):** top swimmer who executes the acrobatic actions or movements on the support or in the air.
- Construction:** generalized name for collaborated work of all athletes according to their assigned role in the acrobatic movement (base + support + featured-swimmer/s). The construction is the "idea", "skeleton", "architecture" of the acrobatic movement.
- Construction of the base:** name of the coordinated actions of team members to form a support (under or at the water's surface) from which (or on which) one or more "featured-swimmer/s" execute acrobatic actions. It includes the base-swimmers, and sometimes spotter/s.

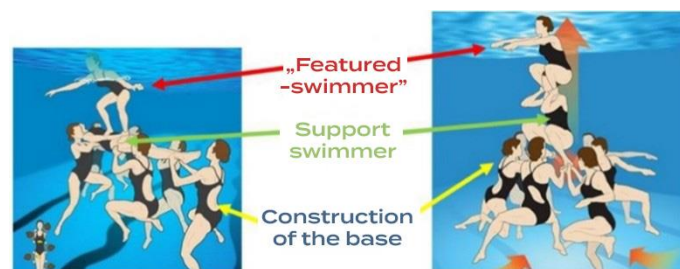



- **Spotter (“helper”)**: one swimmer, with a role of additional support (lift or push) inside the construction. Usually placed close to the “main” construction. In most of the cases they are attached to the featured-swimmer, but there are exceptions. It is possible to have few (1-4) separate spotters or “pair” of spotters (aka “pair-boost”). Their role is to provide additional support/assistance to the featured-swimmer/s and sometimes to the support-swimmer/s (usually it is specified in the description of the construction, connection or bonus).
- For example: a featured-swimmer is lifted on a stack head-down in an owl position and one spotter is holding the front foot of the featured-swimmer.



- **Formation**: two or more groups of swimmers, from which construction is comprised. Well synchronized actions of this group guarantee the execution of acrobatic movements. Without proper work from one of the formations, usually a whole acrobatic movement will fail.

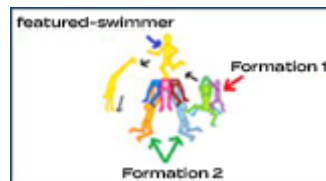

- **Jump**: when a featured-swimmer jumps from the construction using their legs to become airborne with a “repulsion phase”.
- **Throw**: when a featured-swimmer is thrown in the air by the construction of the base or support-swimmer/s. There’s no “repulsion phase” by the feet of the featured-swimmer.
- For example: featured-swimmer is head-down and is pushed and thrown in the air by support-swimmer’s legs.
- **Stack**: when a featured-swimmer sits, stands or lays on “support-athlete/s” which is/are in a vertical body position (head-down or head-up).
- **Lift**: when a featured-swimmer sits, stands or lays on base-swimmers. The featured-swimmer must be lifted up (away) from water’s surface (as high as possible) to be considered as a lift.
- **Onto the support**: when the featured-swimmer jumps from one formation onto another formation and remains on it until the submergence.
- **Through the support**: when the featured-swimmer jumps and passes through another formation (slight touch and continues moving)
- **Platform (Standard)**: coordinated actions of base-swimmers where they lift from underwater a support-swimmer in horizontal position; and the featured-swimmer stands, sits, or lays on the support-swimmer. Some platforms may be formed at the surface.
- **Floats**: coordinated actions of base-swimmers and/or support-swimmers that form a stable geometric figure (from legs, hands or both) at the surface on which a featured-swimmer executes movements. In some exceptions, floats can be lifted from underwater.

**Main Groups**

All the acrobatic movements are divided into 4 Main Groups:

- A - stands for "airborne"
  - All elements in this group are performed by a featured-swimmer in the air.
- B - stands for "balance"
  - Acrobatic movements in this group are performed on a support/base, with connection between support-swimmer/s or base-swimmers from beginning to end.
- P - stands for "platform"
  - The coordinated effort of team members to form a stable support on which one or more swimmers is lifted to pose or perform actions. May have jump or "dismount" ending (water entrance).
- C - stands for "combined"
  - Encompasses combination of the characteristics of all three groups above in the same acro.

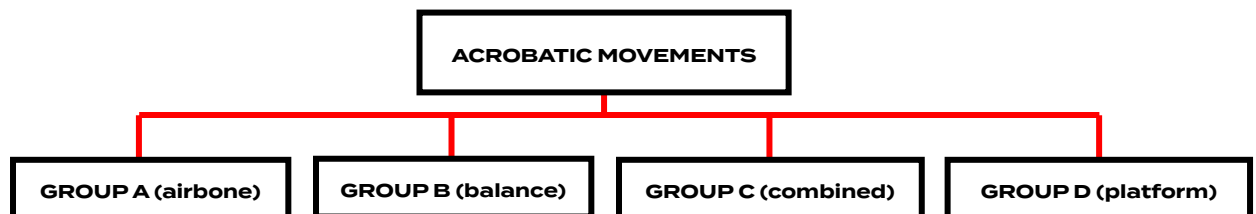

To begin the classification process, videos of past World and European Championships from the years 2008-2024 and some other international competitions in the early 2000s were analysed. This facilitated the classification of acrobatic movements into these 4 main groups.



**Algorithm for the Total Degree of Difficulty**

The "basic" algorithm for calculating DD of each acrobatic movement is:

$$BM + C + S + D + P + R + T + B = DD$$

**BM**- Base Mark of 0.5 points ("start of the value")

**C** – construction

**S** - area of support and type of connection

**D** - direction

**P** - position/s

**R** - rotation of construction

**T** - the plane and degree of rotation

**B** – bonus

**DD** - degree of difficulty

**Note:** *not every acro needs to have all the components*

The **Base Mark** for all the Main Groups is the same and has a **value of 0.5**.

The **Base Mark** is a starting point for the acro code. It means that the DDs of each component will be added to the base mark value.

**29.7.1.2 General Principles & Rules**

**Two Acrobatic Movements**

- If two equal/same acrobatic movements are performed at the same time It will be calculated as one acrobatic movement with a bonus for double acrobatic movements ("Dbl").



- Bonus for double acrobatic movements:
  - Elements judges do not pay attention to the timing, but to the design of the positions.
  - However, if it is declared in the Coach Card that 2 acrobatic movements are supposed to be simultaneous (synchronized actions for double acrobatic movements bonus code "Dbl" used), and they **are obviously performed one after the other** (huge difference in timing) - the bonus will be deemed not executed, and it would put the acrobatic movement to a Base Mark.



- It is *not* allowed to have **2 different** acrobatic movements performed **at the same time**. If this occurs, it will result in a Base Mark for both acrobatic movements.



- Whether there is submersion or not it will be two separate acrobatic movements



**Positions (all Groups)**

- Declared position(s) are the one(s) demonstrated by the featured-swimmer(s).
- All declared positions have an allowance of **45 degrees** from what is written in the tables.
- Note: if the position (Needle, Sail, Queen, Eye) also requires a deviation of the torso (not just degree of the leg movement) – 45 degrees allowance applies separately for torso and leg.
- Example for Needle position:

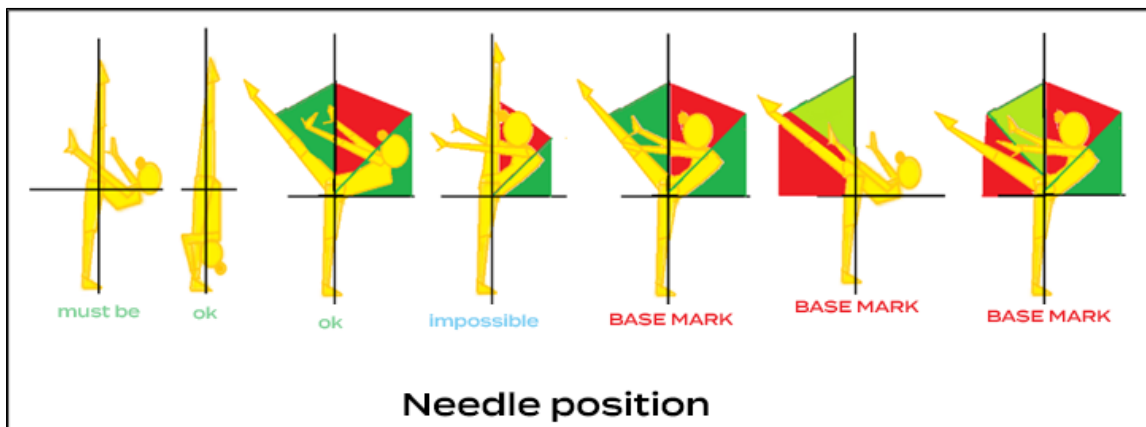

- Unless specified, arms & hands positions/captures are optional.
- Positions **MUST** be clearly shown:
  - We must see a small stop in positions (like in figures), fixed in the clearly defined shape (all relevant parts of the body are in the correct position at the same moment of time).



- All declared positions, in all Main Groups (1<sup>st</sup> Position, 2<sup>nd</sup> Position and the bonus for the 3<sup>rd</sup> position) must be clearly shown and higher than:

**Knees** for head-up positions

**Waist** for head-down positions

**Full body out of water** for horizontal positions

- The **1st Position** is defined as:

Group B (also used in Group P and C):

- The first position clearly shown by the featured-swimmer that is above the height allowance (per above statement).
- Example 1: The featured-swimmer starts at the surface in a tuck position. When the acrobatic movement starts lifting, the athlete opens legs and demonstrates an "owl" position above the waist mark and therefore is OK. In that case, "owl" will be Position 1.
- Example 2: In a Platform, the featured-swimmer is in a pike position underwater. While the construction is lifted up, the featured-swimmer performs a porpoise action to a Bamboo position (completed above waist). In that case, "bamboo" will be Position 1 (and not "box" through which featured-swimmer is passing through during porpoise action).
- Note:** In handstands - Position 1 is always Bamboo (the legs of the featured-swimmer can go through (pass-by) "ow" position or through tuck head-down or through box; unless featured-swimmer goes directly to Position 1 from underwater (for example from tuck on a surface legs open to owl or willow position) or legs must move through the "side" owl position (in previous catalogue "Beluga" position) and in this case coach does not need to declare ow as position 1 unless coach wants to declare it as position 1 and of course there must be a "stop-pause" in owl position.

Group A (also used in Group C):

- The first position clearly shown by the featured-swimmer in the air, following the take-off position.
- Example 1: The featured-swimmer takes-off the construction in a line and then immediately brings the legs to a pike position to perform one somersault. In that case, "pike" will be position 1.
- Example 2: The featured-swimmer takes-off the construction in a line and remains in that position to perform a full twist head-up. In that case, "line" will be position 1 as the line is shown during the main action of the acrobatic (so more than just the take-off position).
- In the picture below, the first declared position will be tuck

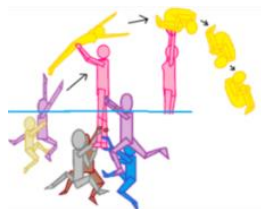

- Positions must be declared in **order of performance**. When a position is clearly shown and is above the height allowance, it **MUST** be declared, and therefore not be skipped.





- Important note:

In groups B and P there are few exceptions (for declaring position 1 and the 1<sup>st</sup> type of connection)

While the construction is rising, the DTC can usually detect that the featured-swimmer for example begins standing on two legs and then moves onto one leg (ie. Heron, Needle, etc.)

This phase of the acro is considered the same as the "take-off" is in group A, so we do not count this "standing/rising" positioning (transitional to Position 1). DTC will check for how long the featured-swimmer holds the "stand (sd)" position. If more than 2 seconds – it will be a base mark.

As long as the athlete is still in the process of standing/rising and doesn't hold a position, it would not be required to declare (for example line in group P)

In addition, the type of connection should be declared as the one where they stand up on 1 leg.
- In regard to positions and type of connection:

Group B:

Positions #1 to 7 (he, vs, gl, ba, sa, ne, ey) must be declared with type of connection #5 (FPx), #19 (F1S), #29 (1F1P) and #30 (1F1F)

We declare type of connection #18 (FS) only when the featured-swimmer remains in a line position from the beginning to the end of the acrobatic movement or when the featured-swimmer clearly stands on 2 legs for the duration of the acrobatic movement

Group P:

Positions #1 to 7 must be declared with the type of connections #3, #4, #9, #19, #20, #21 and #23
- Position 2 **MUST** be a different declared position than position 1 or a BM will be applied.

This means that the same position code can't be declared consecutively, they have to be different position codes from the table. This rule does not apply to the bonus for the third position.

Example 1: Group B: he/2he = **not** possible, but he/2gl = is OK

Example 2: Group A: kt/2kt = **not** possible, but kt/2tk = is OK

Example 3: Group P: bb/2ow + Pos3 bonus (another ow) = OK
- If there is a discrepancy between the images and the written tables:

The "written description" always prevails.

Images are there to show some examples.

Other variations might be possible as long as they respect the "written description".
- In **group C** (constructions Thr<sup>^</sup>2F or Thr<sup>^</sup>Lh or Thr>L)

if there are two featured-swimmers, position 1 indicates the position of the 1st featured-swimmer (who does balance for example) and position 2 indicates the position of the second featured-swimmer (who usually flies, so group A is used).

All other positions of either featured-swimmer must be indicated in the bonus for third position ("Pos3").



- When an acrobatic movement shows two featured-swimmers with *different positions* shown at the same time

You have to declare both positions - with position 1 as the one with the higher DD and position 2 with the lower DD

Can be used (for example) in group C with constructions: Thr+Thr or Sn

- When an acrobatic movement shows two featured-swimmers with *the same position* shown at the same time

You have to declare only one position (due to the rule saying that position 2 must be different than position 1)

Example below: both featured-swimmers perform cobra. The coach declares cobra only once.



- If a *hand capture* is required as per table, we **MUST** see a clear and controlled holding (not a "tap" touch). It must be as a held grasp. There is no duration specified for how long you need to "hold" the capture, as long as it shows clear and controlled grasp.



- Catch/Capture of the leg**

Means when there's a leg kick or in a stable position the arm of the featured-swimmer leans to the leg, the featured-swimmer absorbs the kick action into their arm/hand (same arm/hand, opposite or both – as required by description of the position), and executes a "scoop" and "grab" of the leg/s.

Hand capture (and transition to any hand capture) must happen by the featured-swimmer themselves, by their own ability and without the help of support or base-swimmer(s).



- **Opposite arm means:**

If in the description of a position it is stated that the featured-swimmer must demonstrate **Opposite arm**, the capture cannot be done with the same leg and arm, or it will be a Base Mark!

Example: It must be left leg capture with right arm, but not left leg capture with left arm. Or opposite: right leg capture with left arm, but not right leg capture with right arm

The movement to an opposite arm catch must happen directly – meaning no help from the other arm/hand.

For the **Glass, Eye, Harp** – the featured-swimmer must catch the “moving/kicking” leg with their opposite arm/hand (right arm/hand to left leg, or left arm/hand to right leg)



For example: the featured-swimmer stands on their right leg, the left leg moves, performs kick backwards or sideways and then featured-swimmer must catch the left leg with their right arm/hand.

In **Pin** – the featured-swimmer catches their “back leg” (2 arms blind capture or opposite arm)

For example, the featured-swimmer sits in split position, with the right leg in front and left leg in the back. The featured-swimmer catches their left leg with their right arm. Or if position is laying on the stomach and the left leg is the one “above the head” (back leg), the featured-swimmer must catch it with the right arm.

In **Queen** – this position is exceptional.

For example: the featured-swimmer stands on their left leg, the right leg is in front, vertical and “points upwards”, the featured-swimmer arches backwards and catches their “standing” left leg with the right arm

Eye position – OK (elbows forward)	Eye Position – NOT OK (elbow backwards)	Pin position
		

- “Blind catch” or “blind capture”: means that the featured-swimmer catches their foot or feet without looking with the opposite arm or both arms. Elbow/s look forward – not backwards - not a “side” capture!)
- If nothing is specified in the written description of the position, the capture can be done with either arm.
- If the value is “O” (zero) in the capture column of the table, it means that a capture is not required but may happen.

**Constructions (all Groups)**

- The way the base-swimmers hold each other is optional.
- The way the base-swimmers support the featured-swimmer is optional.

**Area of Support / Type Connections (Groups B and P)**

- If you have 2 types of connections in your acrobatic movements, you MUST declare the first one shown above the surface. You are not allowed to skip the first one and declare the second one instead.
- In groups B and P, the base/support-swimmers cannot help the featured-swimmer achieving positions, but they can help/give additional support in platforms while performing the grip (type of connection).

**Rotations – Plane and Degree (Groups A, C and Bonuses in Group P)**
**Twists (all, including bonuses)**

- The number of twists is calculated until the waist level of the featured-swimmer (visible/clear border for detecting rotations)
- Twist can start during a take-off phase (this applies especially to 2-axis rotations in the air)
- In 2 axes rotations in the air (when acrobatic movement includes somersault and twist): the twist can happen at any time in the acrobatic movement (for example: after completing somersault; while rotating in the air; while taking-off etc.)
- Allowance for 360° Twists and more:  
180° less than declared = Base Mark (note: swimmer can over rotate – you can do more than what is declared).  
Example 1: Declared 720° twist, but only rotated 540° by the waist level (1 ½) = Base Mark  
Example 2: Declared 720° twist, and rotated 630° by the waist level (1 ¾) = Ok
- Allowance for 180° twists:  
There is no allowance – performing less than a 180° is a Base Mark.

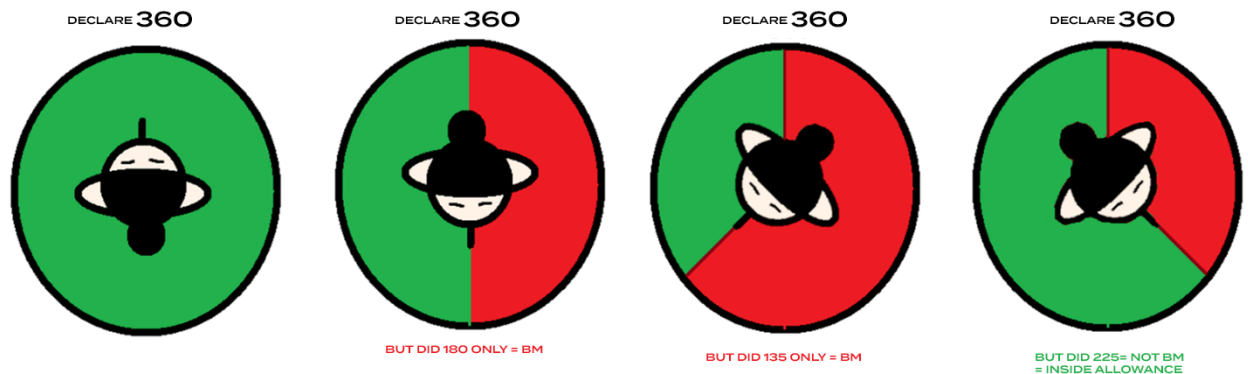

- Important: Twists can be started with legs together (after take-off) or with the fast kick forward action during the take-off phase (before twisting). We do not consider it as a position, regardless of the degree of the kicking leg (the degree of the “kicking leg” can be more than 90°)!

**Somersaults (all, including bonuses)**

- The number of somersaults is calculated until *the beginning of the submergence* of the featured-swimmer.
- Beginning of submergence – means not “a slide of the body part” or “body part submerging and then coming back and appearing above the surface”, but when the body of the featured-swimmer goes directly into the water and never “rises-up again”. Beginning of submergence starts to be counted when a quarter of the body “disappears” underwater.
- Allowance for **all somersaults** (regular/frontal/two axes, etc.) is **90° less** than declared before submergence = Base Mark (note: swimmer can over rotate – you can do more than was declared).
- *Note: if you are trying a somersault backwards 360o in a flexibility position (for example: Ring), and the athlete can't complete a 360o somersault (with allowance) – you can instead declare “Jump-Dive” and stay inside “the rule of allowance” that you can over-rotate but at least “pass” the required rotation.*
- Technical controller tips: when we speak about rotations in the air, about allowances and how to see if the featured-swimmer passed the “border line” and enters the “safe” zone, we look at part “from shoulders to knees” (this rule applies for positions: line/arch position; variations of kite and jay positions)

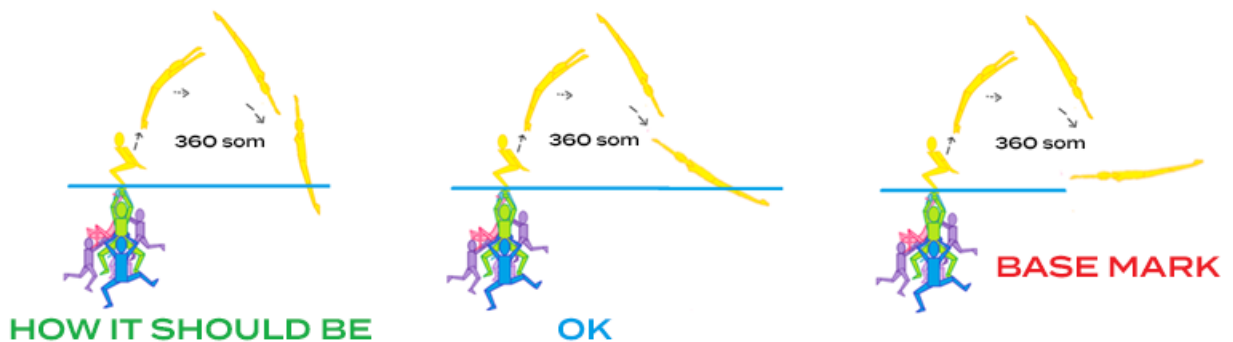
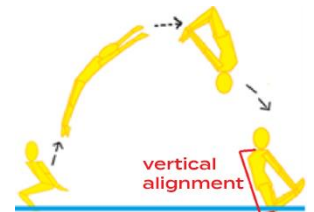
**Cartwheels and handsprings (all, including bonuses)**

- In **Cartwheels and Handsprings** the same rule as somersaults applies: **90° less** than declared before submergence = Base Mark.

**Rotations of the Base (for Group B and C)**

- The number of rotations of the construction is calculated until the waist level of the featured-swimmer (visible/clear border for detecting rotations). It must be a “visible” rotation: the support-swimmer turns with the featured-swimmer on top while submerging. It is not just a turn of the body of the featured-swimmer.
- The rotation may start during the ascent.
- Allowances for 360° and more:
  - 90° less than declared = Base Mark (note: swimmer can over rotate – you can do more than what is declared).
  - Example 1: Declared 720o rotation, but only rotated 540o by the waist level (1 ½) = Base Mark
  - Example 2: Declared 720o rotation, and rotated 675o by the waist level (1 ¾) = Ok
- Allowance for 180°:
  - There is no allowance – performing less than a 180° is a Base Mark.

**Rotations of the Base (for Group P)**

- The rotation of the construction is calculated until the *knees* of the featured-swimmer (if the position is head-up) or *waist* (if the position of the featured-swimmer is head-down)
- Rotation will only begin to be counted once platform is at maximum height. If during the rotation the featured-swimmer significantly loses height (ie. knees of the featured-swimmer if position is head-up go under, or waist goes under if position of featured-swimmer is head-down) – it's a base mark if the construction has not completed declared rotation (considering allowance) at this point.
- Rotation may start during the ascent, but the TC will start counting the degrees of rotation from the moment construction reaches its maximum height.
- *Allowances for 180° and more:* 45° less than declared = Base Mark (note: swimmer can over rotate – you can do more than was declared).
- *Allowance for 90°:* There is no allowance – performing less than 90° is a Base Mark. It must be done precisely (or more).

**Bonus (all Groups)**

- Any bonus can be declared only **ONCE** per acrobatic movement, unless specified otherwise (ex: "C-Roll" can be declared twice)
- A maximum of **two (2) different bonuses** can be declared per acrobatic.
- Some bonuses cannot be declared with another bonus of the same "category". If it is the case, it will be stated in the chart.
- When, fly above 2<sup>nd</sup> formation or fly above lift on heads is declared, it *MUST* be performed (the flying phase) when the featured-swimmer of the second formation (above which the featured-swimmer flies) is at the "positions allowance safe zone" or higher (Waist or Knees).

**Minimum Declaration Requirements**

- If you declare an acrobatic movement, you cannot "skip" some required parts of the acrobatic movements - the following components of each group **MUST** always be declared, while the other components (not listed below) are optional:

GROUP A must have: CONSTRUCTION + DIRECTION + POS 1

GROUP B must have: CONSTRUCTION + TYPE OF CONNECTION + POS 1

GROUP P must have: CONSTRUCTION + TYPE OF CONNECTION + POS 1

GROUP C must have: CONSTRUCTION + DIRECTION + POS 1

*Not respecting the requirements will result in a Base Mark.*

- Example 1: The coach declares group B, Stack. Palms/palms connection and bamboo as position 1. But the coach is not sure if the featured-swimmer will be able to complete 2<sup>nd</sup> position until waist level before submerging. So, the coach declares all "minimum required" components (ie. Construction+ type of connection+ pos 1). The featured-swimmer can still perform position 2 without risk to receive a base mark.
- Example 2: The same acro as above plus position 2 and rotation of the stack 180°. The coach is not sure if the featured-swimmer will be able to complete 180° rotation of the construction respecting the allowances. So, the coach declares all the "minimum required" components (ie. Construction+ type of connection+ position 1 also position 2 (if the coach is sure). The featured-swimmer can still perform the rotation of the construction without risk to receive a base mark.
- Example 3: same acro (group B, Stack. Palms/palms connection and bamboo as position 1, owl as position 2, and stack turning 180°) plus 3<sup>rd</sup> position (as bonus 1) and twirl (as bonus 2). The coach is still not sure if the swimmers are safe to perform the stack 180° rotation of the construction. So, the coach declares all components except the rotation of the construction, but swimmers are still allowed to attempt to do it.



- As you see, the “skeleton” (minimum requirement) is always there: construction + grip + position 1

**Clarification to Rule in Appendix 3,4 and 5**

Acrobatics must not be repeated in the same routine. “Must not repeat the same acrobatic” is defined as:

<p><i>For Group A:</i> Can't repeat same position/s (as P1 or as P2 with the exception of the third position bonus). Examples:</p>
<p>In one routine – <u>Not</u> allowed:</p> <p><b>A-Sq-Back-pk/2In-s1</b> ❌  <b>A-Sq-Back-pk/2ja-s1</b> ❌</p>
<p>In one routine – this is OK:</p> <p><b>A-Sq-Back-pk/2In-s1</b> 😊  <b>A-Sq-Back-tk/2spl-s1</b> 😊</p>
<p><b>Note:</b> in group A, you must not repeat any of the positions declared in another acro from group A even if you change the construction, direction, bonuses or rotation in the air</p>

<p><i>For Group B:</i> Can't repeat the same construction, can't repeat the same type of connection (grip). Examples:</p>
<p>In one routine – <u>Not</u> allowed:</p> <p><b>B-St-1P1P-bb/2ow</b> ❌  <b>B-St-PP-bb/2ow</b> ❌</p>
<p>In one routine – this is OK:</p> <p><b>B-St-1P1P-bb/2ow</b> 😊  <b>B-StH-FF-sd</b> 😊</p>
<p><b>Note:</b> in group B, you must not repeat any of the constructions, type of connection (grip) declared in another acro of group B even if you change the position/s, bonuses or rotation of the construction</p>

<p><b>For Group C:</b> Can't repeat the same construction. Examples:</p>
<p>In one routine – <u>Not</u> allowed:</p> <p><b>C-Thr&gt;St-BIn-tk-Cs1</b>  <b>C-Thr&gt;St-Forw-sd/2tk-Cd-Jump</b> ❌</p>
<p>In one routine – this is OK:</p> <p><b>C-Thr&gt;St-BIn-tk-Cs1</b> 😊  <b>C-Thr&gt;F-Forw-sd/2tk-Cd-Jump&gt;</b> 😊</p>
<p><b>Note:</b> in group C, you must not repeat any of the constructions declared in another acro of group C even if you change the position/s, direction, bonuses, rotation in the air or rotation of the construction</p>



*For Group P:* Can't repeat the same construction, can't repeat the same type of connection (grip), can't repeat same position/s (as P1 or as P2 with the exception of the third position bonus). Examples:

In one routine – Not allowed:

**P-Knees-SP+K-bb/2ow**

**P-Knees-3pA-ne**



In one routine – this is OK:

**P-Knees-SP+K-bb/2ow**

**P-2S-FA+PF-ne/2ey**





**Note:** *in group P, you must not repeat any of the positions, any of the constructions, type of connection (grip) declared in another acro of group P even if you change the bonuses, or rotation in the construction.*



- Q&A Note: P1 and/or P2 limit is applicable to the specific group, but it can be done in others.  
For example: In a Platform, the featured-swimmer performs an owl position, the featured-swimmer can repeat an owl position in another acro of group B.

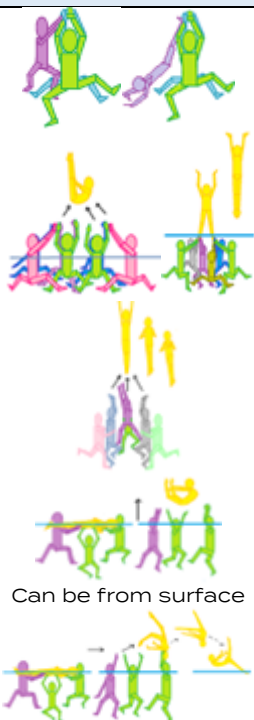

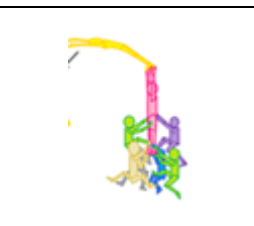
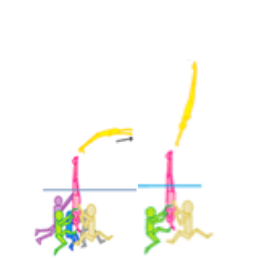
**29.7.1.3 Group A**
**Component C – Construction**

No.	PICTURE	NAME AND NUMBER OF LEVELS	CODE	DIFFICULTY OF COORDINATING ACTIONS AND NUMBER OF FORMATIONS	SUPPORT: BODY POSITION AND LEVEL OF SUSTAINABILITY	AIR-BORNE WEIGHT	SIZE OF CONSTRUCTION/WATER RESISTANCE	TEMPO OF ACCELERATION AND PUSH (LIFT/THROW)	AREA OF SUPPORT FROM WHICH FEATURED-SWIMMER JUMPS	TOTAL
1	 <p>Simple jump/throw 2 levels</p> <p>(Note: If in routine of 8 swimmers for example coach decides to do "double acro"- coach divides swimmers in 2 groups of 4 swimmers and declare Thr plus bonus for Double acro if the idea is to perform same/equal acrobatic movement in the same time)</p> <p>Can be from surface</p>		Thr	Low	no	1	Type 1	fast	-	<b>0.60</b>
				0.1	0	0.1	0.1	0.3	0	
2	 <p>Jump/throw from shoulders (stack type) 3 levels</p> <p>May have spotter/s</p>		Shou	Med	High level of sustainability+ low vestibular load	1+0.5	Type 2:	med	Med	<b>0.90</b>
				0.2	0	0.15	0.15	0.2	0.2	
3	 <p>Jump/throw from hands 3 levels</p>		Hand	Med	High level of sustainability+ low vestibular load	1+0.5	Type 2:	slo-med	Extra-Small	<b>0.95</b>
				0.2	0	0.15	0.15	0.1	0.35	
4	 <p>Jump/ throw from feet (stack type) 3 levels</p>		Feet	Med	Low level of sustainability+ high vestibular load+ blind connect	1+0.5	Type 2:	slo-med	Small	<b>1.00</b>
				0.2	0.1	0.15	0.15	0.1	0.3	

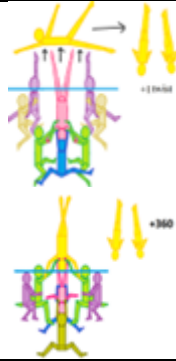

5	 <p>Must have at least 2 people doing basket +1 leg-pusher (support-swimmer) + at least 1 swimmer pushing "leg-pusher" + featured-swimmer = in total 1 featured-swimmer +4 base-swimmers who form Sq construction</p>	<p>Jump from square ("basket")</p> <p>3 levels</p>	<b>Sq</b>	Hard	Head-down swimmer counts as a support (0.2+0.1+0.1)	1+0.5+0.5+0.5	Type 2-3	fast	Big	<b>1.15</b>
				0.3	0.1	0.25	0.1	0.3	0.1	
6	 <p>Jump/throw from two supports head-up, disconnection and enter the water</p> <p>3 levels</p> <p>(may have additional pusher head-down or head up)</p>		<b>2Sup</b>	Hard	High level of sustainability+ low vestibular load	1+0.5+0.5	Type 3	slow-medium	Med	<b>1.00</b>
				0.3	0	0.2	0.2	0.1	0.2	
7	 <p>Jump/throw from two supports, from which at least one of them is head down</p> <p>3 levels</p> <p>(may have additional pusher head-down or head-up)</p>		<b>2Sup H</b>	Hard	Low level of sustainability+ high vestibular load. doesn't matter how many supports+ blind connect	1+0.5+0.5	Type 3	slow-medium	Med	<b>1.10</b>
				0.3	0.1	0.2	0.2	0.1	0.2	

**Notes on Group A Constructions:**



Constructions 6 and 7 can be done with or without a pusher in the middle of the 2 supports. The pusher can be head-up or head-down and may have additional swimmer(s) under for assistance.

When both supports are head-down, they can provide support to the featured-swimmer as such: 1+1 foot, 2+2 feet, or a combination of 1 foot+2 feet

If both supports are head-up (or only one of them), the way of pushing is optional. For example: push can be done with the palms of the support-swimmer, or featured-swimmer can jump from support's shoulders (unless specified).

**Component D – Direction**

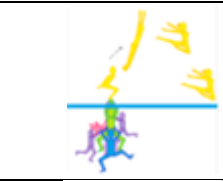
Direction: Defined as the direction of the jump of the featured-swimmer

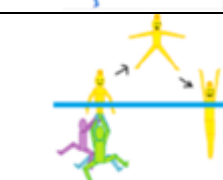
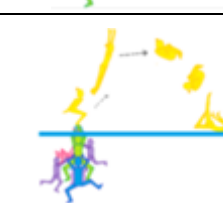
DIRECTION	CODE	DIAGRAM	VALUE
<b>Upwards</b> The featured-swimmer jumps up (or is thrown in the air by construction) and returns to the same spot they jumped from. The featured-swimmer can execute the entrance into the water or back on the construction.	<b>Up</b>		<b>0.05</b>
<b>Forwards</b> The featured-swimmer jumps forwards (or is thrown in the air in this direction by construction) and enters the water in front of the construction.	<b>Forw</b>		<b>0.05</b>
<b>Backwards</b> The featured-swimmer jumps backwards (or is thrown in the air in this direction by construction) and enters the water behind the construction.	<b>Back</b>		<b>0.10</b>
<b>Sideways</b> The featured-swimmer jumps sideways (or is thrown in the air in this direction by construction) and enters the water on the right/on the left the construction.	<b>Side</b>		<b>0.20</b>
<b>Reverse*</b> The featured-swimmer jumps forwards (or is thrown in the air in this direction by construction) and then starts rotating backwards (facing the construction that the athlete jumps from) and enters the water in front of the construction.	<b>Rev</b>		<b>0.40</b>

*\*A Health and Safety consideration: due to the high risk involved in this type of movement, inwards direction (jumping backwards and turning forwards- so called "turning under yourself") rotation in the air is not allowed and will not be granted a new code, even upon request.*



## HOW TO DETERMINE THE DIRECTION

### Head-up Jumps:

You must choose the direction the featured-swimmer demonstrates during the "take-off" phase (at the beginning of the acrobatic movement).

- Example 1: If the featured-swimmer starts a jump backwards then turns in the air around self (twisting action) and then starts somersaulting forwards = declare Backwards (Back)
- Example 2: If the featured-swimmer starts a jump forward and continues in the same direction executing a 360o somersault forwards = declare Forwards (Forw)
- Example 3: Jump from a square backwards, the featured-swimmer after take-off turns 180o and starts a 540o somersault forwards. After performing 360o somersault in tuck position, the featured-swimmer opens to a straight body position (ie. Line) while continuing with more 180o somersault and enters the water head-first.

The code should be: A-Sq-Back-tk/2ln-s1,5t0,5fo



- Example 4: Jump from square forwards, the featured-swimmer after take-off starts 540o somersault forwards. After performing 360o somersault in tuck position, the featured-swimmer opens to a straight body position (ie. Line) while continuing with one more 180o somersault and enters the water head-first

The code should be: A-Sq-Forw-tk/2ln-s1,5fo



### Head-Down Jumps (ie. Throws):

In throws, you must choose the direction where the featured-swimmer is thrown (where it moves). Exception: If there is a somersault, choose the direction of the rotation instead.

- Example 1: If the featured-swimmer is head-down and thrown backwards, and then starts somersaulting forwards = declare forwards (Forw)
- Example 2: If the featured-swimmer is head-down and is thrown backwards with no rotation= declare backwards. (Back)





### Cartwheels:

The direction is Sideways (Side).



### Handsprings:

The direction is Forwards (Forw) or Backwards (Back).

**Component P – Position**

NO.	PICTURE	NAME AND CODE	DIFFICULTY TO BALANCE	PRESENCE OR ABSENCE OF A HELPING HAND (CAPTURE)	TYPE AND LEVEL OF FLEXIBILITY+ DEVIATION OF TORSO FROM INNER AXIS	TOTAL	VALUE OF POSITION 2 (HALF VALUE OF POS 1)	CODE FOR POSITION 2
<b>FORWARD FLEX STOMACH</b>								
1	 <p>Important: knees must be within 90 degrees of chest (plus always consider 45° position allowance)</p>	Tuck	No	Can be with or without hands	Stomach flex 1 (bent legs!)	basic <b>0.10</b>	<b>0.05</b>	<b>2tk</b>
		<b>tk</b>	○	○	○			
2	 <p>Important: flexion at hip level with one or two legs (straight) touch stomach and/or chest</p>	Pike	No	Can be with or without hands	Stomach flex 2	<b>0.20</b>	<b>0.10</b>	<b>2pk</b>
		<b>pk</b>	○	○	0.2			
<b>MISCELLANEOUS</b>								
3		Kite	No	Can be with or without hands	Free body position (different from straight or open body, tuck or line) with flexion at hip level of 90 degrees or less (one or two legs sideways or forwards or backwards)  Knee(s) may be bent.  May have a small arch in back	basic <b>0.05</b>	<b>0.025</b>	<b>2kt</b>
		<b>kt</b>	○	○	○			
4		"Open body" Line/Arch	No	-	Misc (straight body, may have small arch in back). Legs can be straight and/or spread in 45 degrees out of vertical line diapason	basic <b>0.10</b>	<b>0.05</b>	<b>2ln</b>
		Can have "open" leg variations or 1 significantly (90 degrees) bent leg	○	○	○			
5		Split	No	Can be with or without hands	180 between legs can be different variations, however both legs should be straight  (both legs must be in 45° cone from 180 line that is formed by legs)	<b>0.30</b>	<b>0.15</b>	<b>2sp</b>
		<b>sp</b>	○	○	0.3			



ARCHED								
6		Jay	No	-	Arch in back+1 leg back straight 90 degrees and more	0.20	0.10	2ja
		ja	0	0	0.2			
7	 At least toes of one foot must touch head (or be within 45 degrees as per position allowance)	Ring	No	Can be with or without hands	Arch (maximum flex in back).	0.30	0.15	2rg
		rg	0	0	0.3			

Regarding the 45 degree position allowance for Split:

- For a “pass” both front and back legs need to be at 45 degrees or higher (ideal and Ok images below)
- If even one leg (front or back) drops lower than 45 degrees (may look more like Knight or Crane), or both legs are lower than of 45 degrees - it’s a BM (last image)

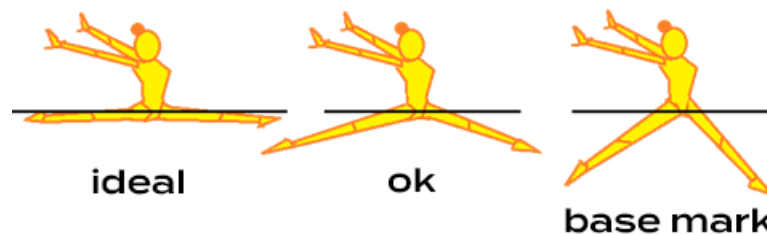

#### Component S – Area of Support

N/A for Group A (value already inside construction)

#### Component R – Rotation of the Construction Base

N/A for Group A

#### Component T – Plane and Degree of Rotations

- If there’s a half somersault/dive (when the featured-swimmer jumps head-up forwards or backwards and after demonstrating a parabola in the air enters the water head-first, or after take-off performs a position or positions and enter the water head-first, it should be written in the code as the letter “d” with indicated number of twists (if there are any)
- Not entering water head-first in this situation would be counted just as a change of the position and will not be written as dive/half somersault.

**How to Calculate Somersault Rotations:**

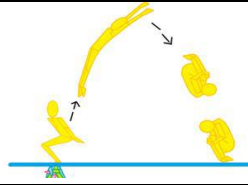
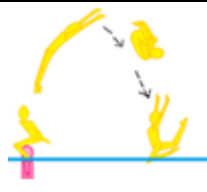
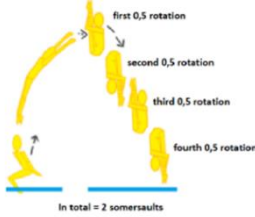
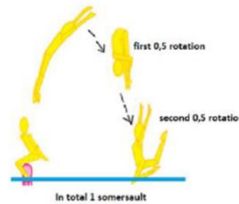
<p>To get value for a “full somersault” the featured-swimmer who jumps head-first needs to enter the water feet-first (after “full” rotations ie 360°, 720°, 1080°). For example: tuck position, straight body positions.</p>	
<p>For “Open” positions or variations of arch positions (Jay, Kite, etc) – the featured-swimmer must enter the water demonstrating vertical alignment between shoulders and knees to get a full somersault.</p>	
<p>Pike somersault (without changing the body position throughout the rotation): We count somersaults in a pike position the same way that diving does. The first 180-degree movement of the legs after take-off is considered as the first half of the rotation and then count from there.</p>	 <p>In total = 2 somersaults</p>
<p>If the somersault is performed using 2 positions – for example Pike and Jay: we count the number of somersaults in our regular method where we look how many times the torso with the head turns each 180.</p>	 <p>In total 1 somersault</p>

- Notes regarding codes:

When “forwards” is beside the degree of rotation, it means the direction in which the actual somersault in the air is happening.

When “straight body” is beside the degree of rotation, it means that the featured-swimmer needs to keep a straight body position from the take-off until the end. A small arch in the back is allowed (as positions have a 45-degree allowance). It is possible to have a small kick action after take-off, which is not declared as a position.

When “open” is beside the degree of rotation it means for example:

- 540° somersault + open = 360° in position + 0.5 open to Line Position
- 720° + open = 540° in position + 0.5 open to Line Position
- To qualify for “open” the Line position MUST be declared as Position 2 or be performed as the 3rd position bonus AND it must be performed by the knees (head-up) or waist (head-down)



<b>Horizontal plane (all twists: horizontal. head-up. head-down) - turns around self to the left or right (Performed in the air)</b>							
Degree of rotation	Code	value	2nd axis	forw	straight body	open	total
180°	<b>t0.5</b>	0.025					<b>0.025</b>
360°	<b>t1</b>	0.05					<b>0.05</b>
540°	<b>t1.5</b>	0.10					<b>0.10</b>
720°	<b>t2</b>	0.20					<b>0.20</b>
900°	<b>t2.5</b>	0.25					<b>0.25</b>
1080°	<b>t3</b>	0.30					<b>0.30</b>

<b>Sagittal plane (Example: forward somersault) - turns around self - forwards or (Performed in the air)</b>									
Degree of rotation	Code	value	2nd axis	forw	straight body	open	bo-nus	total	
180° somersault /dive (any direction)	<b>d</b>	0.025	0.025				0.025	<b>0.075</b>	
180° somersault /Dive + 180° twist (any direction)	<b>dt0.5</b>	0.025	0.05				0.025	<b>0.10</b>	
180° somersault /Dive + 360° twist (any direction)	<b>dt1</b>	0.025	0.1				0.025	<b>0.15</b>	
180° somersault /Dive + 540° twist (any direction)	<b>dt1.5</b>	0.025	0.2				0.025	<b>0.25</b>	
180° somersault /Dive + 720° twist (any direction)	<b>dt2</b>	0.025	0.25				0.025	<b>0.30</b>	
360° somersault	<b>s1</b>	0.3						<b>0.30</b>	
360° somersault forwards	<b>s1f</b>	0.3		0.1				<b>0.40</b>	
360° straight body somersault	<b>ss1</b>	0.3			0.2			<b>0.50</b>	
360° straight body somersault forwards	<b>ss1f</b>	0.3		0.1	0.2			<b>0.60</b>	
540° somersault	<b>s1.5</b>	0.55						<b>0.55</b>	
540° somersault forwards	<b>s1.5f</b>	0.55		0.1				<b>0.65</b>	
540° somersault + open	<b>s1.5o</b>	0.55				0.3		<b>0.85</b>	
540° somersault forwards + open	<b>s1.5fo</b>	0.55		0.1		0.3		<b>0.95</b>	
720° somersault	<b>s2</b>	0.8						<b>0.80</b>	
720° somersault + open	<b>s2o</b>	0.8				0.5		<b>1.30</b>	
720° somersault forwards	<b>s2f</b>	0.8		0.1				<b>0.90</b>	
720° somersault forwards + open	<b>s2fo</b>	0.8		0.1		0.5		<b>1.40</b>	
900° somersault	<b>s2.5</b>	1						<b>1.00</b>	
900° somersault forwards	<b>s2.5f</b>	1		0.3				<b>1.30</b>	
1080° somersault	<b>s3</b>	1.5						<b>1.50</b>	





<b>Frontal plane (Example: Side somersault) - turn to the left or to the right (sideways movements - Performed in the air)</b>								
Degree of rotation	Code	value	2nd axis	forw	straight body	open	bonus	total
360° side somersault	<b>f1</b>	0.3					0.1	<b>0.40</b>
540° side somersault	<b>f1.5</b>	0.5					0.1	<b>0.60</b>
720° side somersault	<b>f2</b>	0.7					0.1	<b>0.80</b>

<b>Cartwheels and Handsprings</b>								
<b>(part of rotation starts with connection to support) ANY DIRECTION</b>								
<b>Usually, starts on a support and partially performed on it. Then featured-swimmer becomes airborne, performs rotation in the air and enters the water (featured-swimmer may keep hand-connection with support until submergence)</b>								
Degree of rotation	Code	value	2nd axis	forw	straight body	open	bonus	total
Cartwheel	<b>c</b>	0.1						<b>0.10</b>
Cartwheel + half twist	<b>ct0.5</b>	0.1	0.025				0.025	<b>0.15</b>
Cartwheel + 1 twist	<b>ct1</b>	0.1	0.05				0.025	<b>0.175</b>
Handspring	<b>h</b>	0.1						<b>0.10</b>
Handspring + 180° twist	<b>ht0.5</b>	0.1	0.025				0.025	<b>0.15</b>
Handspring + 360° twist	<b>ht1</b>	0.1	0.05				0.025	<b>0.175</b>
Handspring + half somersault (dive)	<b>hd</b>	0.1	0.025					<b>0.125</b>
Handspring + 1 somersault	<b>hs1</b>	0.1	0.3					<b>0.40</b>
Half-Handspring + 1.5 somersault (with or without opening)	<b>h0.5s1.5</b>	0.05	0.4					<b>0.45</b>
Half-Handspring + 1 somersault (with or without opening)	<b>h0.5s1</b>	0.05	0.3					<b>0.35</b>

Example: half handspring + 1 somersault

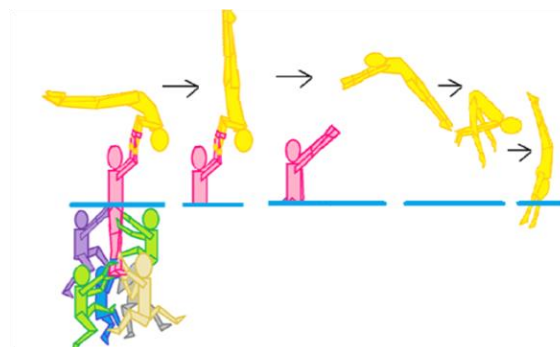



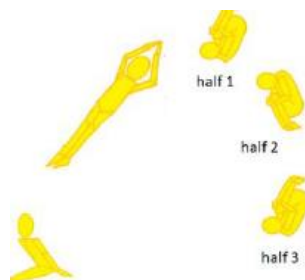

<b>Two-axes somersaults (have additional bonus for using both axes 0,025) (Performed in the air)</b>								
Degree of rotation	Code	value		forw	straight body	open	bonus	total
		som.	twist					
1 somersault + 0.5 twist	<b>s1t0.5</b>	0.3	0.05				0.1	<b>0.45</b>
1 somersault + 0.5 twist forwards	<b>s1t0.5f</b>	0.3	0.05	0.1			0.1	<b>0.55</b>
1 somersault + 1 twist	<b>s1t1</b>	0.3	0.1				0.1	<b>0.50</b>
1 somersault + 1 twist forwards	<b>s1t1f</b>	0.3	0.1	0.1			0.1	<b>0.60</b>
1 somersault + 1.5 twist	<b>s1t1.5</b>	0.3	0.15				0.1	<b>0.55</b>
1.5 somersault + 0.5 twist	<b>s1.5t0.5</b>	0.55	0.025				0.1	<b>0.675</b>
1.5 somersault + 0.5 twist forwards	<b>s1.5t0.5f</b>	0.55	0.025	0.1			0.1	<b>0.775</b>
1.5 somersault + 0.5 twist + open	<b>s1.5t0.5o</b>	0.55	0.025			0.3	0.1	<b>0.975</b>
1.5 somersault + 0.5 twist + open forwards	<b>s1.5t0.5fo</b>	0.55	0.025	0.1		0.3	0.1	<b>1.075</b>
1.5 somersault + 1 twist	<b>s1.5t1</b>	0.55	0.05				0.1	<b>0.70</b>
1.5 somersault and 1.5 twist	<b>s1.5t1.5</b>	0.55	0.125				0.1	<b>0.775</b>
2 somersaults + 0.5 twist	<b>s2t0.5</b>	0.8	0.025				0.1	<b>0.925</b>
2 somersaults + 0.5 twist forwards	<b>s2t0.5f</b>	0.8	0.025	0.1			0.1	<b>1.025</b>
2 somersaults + 0.5 twist + open	<b>s2t0.5o</b>	0.8	0.025			0.5	0.1	<b>1.425</b>
2 somersaults + 0.5 twist + open forwards	<b>s2t0.5fo</b>	0.8	0.025	0.1		0.5	0.1	<b>1.525</b>
2 somersaults + 1 twist	<b>s2t1</b>	0.8	0.075				0.1	<b>0.975</b>
2 somersaults + 1 twist + open	<b>s2t1o</b>	0.8	0.075			0.5	0.1	<b>1.475</b>
2 somersaults + 1 twist forwards + open	<b>s2t1fo</b>	0.8	0.075	0.1		0.5	0.1	<b>1.575</b>
Straight somersault 1 + 0.5 twist	<b>ss1t0.5</b>	0.3	0.025		0.275			<b>0.60</b>
Straight somersault 1 + 0.5 twist forwards	<b>ss1t0.5f</b>	0.3	0.025	0.1	0.275			<b>0.70</b>
Straight somersault 1 + 1 twist	<b>ss1t1</b>	0.3	0.05		0.275			<b>0.625</b>
Straight somersault 1 + 1 twist forwards	<b>ss1t1f</b>	0.3	0.075	0.1	0.275			<b>0.75</b>
Straight somersault 1 + 1.5 twist	<b>ss1t1.5</b>	0.3	0.125		0.3		0.075	<b>0.80</b>
Straight somersault 1 + 2 twists	<b>ss1t2</b>	0.3	0.2		0.3		0.1	<b>0.90</b>
Straight somersault 1 + 2.5 twists	<b>ss1t2.5</b>	0.3	0.25		0.3		0.175	<b>1.025</b>
Straight somersault 1 + 3 twists	<b>ss1t3</b>	0.3	0.3		0.3		0.225	<b>1.125</b>

Example: 1.5 somersault+ 1.5 twist:

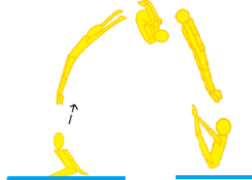

**Component B – Bonus**

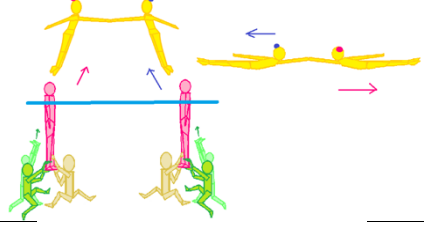
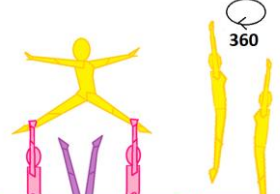

List of additions, bonuses, and risk-elements in Group A				
Code	For Group A:	Value		
<b>Dbl</b>	<p><b>Synchronized actions for double acrobatic movements</b></p> <p>Where swimmers are divided into two groups (separate small constructions. usually, 3 swimmers underwater + 1 featured-swimmer) and who perform identical (equal/same) simultaneous acrobatic movements.</p> <p>Note 1: "Mirror action" is possible – ie constructions face each other and featured-swimmers both jump backwards or to each-other</p> <p>Note 2: The two featured-swimmers may be connected with each other</p>		<b>0.20</b>	
<b>Pos3</b>	<p><b>Third position</b></p> <p>This bonus should be declared only once no matter how many positions featured-swimmer will perform after the first and second declared positions.</p>		<b>0.05</b>	
Can't be in the same acro! You need to choose 1 of these!	<b>Grip</b>	<p>Connection between <b>2 featured-swimmers from the beginning</b> of the acrobatic movement and remain connected until submergence</p>		<b>0.10</b>
	<b>Conn</b>	<p>Connection between <b>support and featured-swimmer</b> (may disconnect before water entrance)</p> <p>NOTE: use this code if you have a hand-spring/ cartwheel in your acro</p>		<b>0.10</b>
	<b>Catch</b>	<p>Connection between <b>2 featured-swimmers during airborne phase</b> and remain connected until submergence (connection occurs after take-off)</p> <p>Can only be declared with other bonus Dbl</p>		<b>0.15</b>
<b>Split</b>	<p><b>Jump/Throw from split</b> (head-up) position</p> <p>Note: as position 1 coach should indicate line or kite or tuck (depending on how the acro is performed), because split is considered as "take-off" phase</p>		<b>0.15</b>	







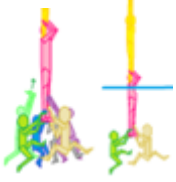

<p>Can't be in the same acro! You need to choose one of these!</p>	<p><b>Hula</b></p> <p><b>"Hulahoop" action</b></p> <p>Featured-swimmer in ring/jay position enters water with support-swimmer inside the circle (which is made from legs/hands connection of featured-swimmer)</p>		<p><b>0.30</b></p>
	<p><b>RetSq</b></p> <p><b>"Return" on the "Square" construction (Sq) after the airborne phase</b></p>		<p><b>0.60</b></p>
	<p><b>RetPa</b></p> <p><b>"Return" on support's hands</b> after the airborne phase, before submergence.</p> <p>Featured-swimmer needs to clearly land on hands of the support. Support needs to be <b>not lower than waist level</b></p>		<p><b>0.50</b></p>
	<p><b>Feet</b></p> <p><b>Jump from feet</b> (feet/feet connect between support and featured-swimmer)</p>		<p><b>0.025</b></p>

**29.7.1.4 Group B**
**Component C – Construction**

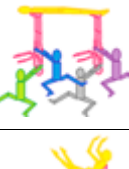

**Note:** Unless specified otherwise - (the featured-swimmer remains from beginning to the end on support/s or base-swimmers)

No.	Picture	Name and number of levels	Code	Difficulty of coordinating actions and number formations	Support: Body position and level of sustainability	Support: Type and level of flexibility or maintain position	Air-borne weight	Area of full construction, Proximity between swimmers	Tempo of acceleration and push (lift/throw)	Total
1		Stack (classic) OR Stack + spotter/s (1 or 2 or 3 or 4 or more)	<b>St</b>	Med-Hard	High level of sustainability+ low vestibular load	Free body position	1+1	Type 2	Med-fast	<b>1.00</b>
				0.25	0	0.1	0.2	0.2	0.25	
2		Stack head-down Support in any position also can have spotters (from 1 to 4)	<b>StH</b>	Med-Hard	Low level of sustainability+ high vestibular load	Free body position	1+1	Type 2	Med-fast	<b>1.10</b>
				0.25	0.1	0	0.2	0.3	0.25	



3		Stack 2 head-up supports (f-swimmer remains from beginning to the end on support-swimmers)	<b>2SupU</b>	Hard	High level of sustainability+ low vestibular load (0.1+0.1)	straight body 1+1	1+0.5+0.5	Type 2	big-med	<b>1.05</b>
				0.3	0	0.2	0.2	0.2	0.15	
4		Stack 2 head-down supports	<b>2SupD</b>	Hard	Low level of sustainability+ high vestibular load 1+1	straight body 1+1	1+0.5+0.5	Type 2	med	<b>1.30</b>
				0.3	0.2	0.2	0.2	0.2	0.2	
5		Stack 2 supports (one of them head-down)	<b>2SupM</b>	Hard	Combined (1 head-up+1 head-down)	straight body 1+1	1+0.5+0.5	Type 2	big-med	<b>1.15</b>
				0.3	0.1	0.2	0.2	0.2	0.15	
6		Stack 2 head-down supports+2 featured-swimmers	<b>2SupD 2F</b>	Hard	Low level of sustainability+ high vestibular load 1+1	straight body 1+1	1+1+0.5+0.5	Type 2	med	<b>1.60</b>  (+0.2 bonus for connection between 2 f.swimmers)
				0.3	0.2	0.2	0.3	0.2	0.2	
7	Can be done from surface	Simple Lift	<b>L</b>	Low	no	no	1+ bonus	Type 1	fast	<b>0.70</b>  The way base-swimmers hold each-other and/or featured-swimmers-is optional (can be as combo. of supporting on heads and shoulders of the base-swimmers etc)
					0.1	0	0	0.2	0.1	
8		Lift two featured-swimmers or more (they must form 1 construction) and must be connected!	<b>L2F+</b>	Medium	no	no	2	Type 1	slow-med	<b>0.80</b>  (+0.2 bonus for connection between 2 or more f.swimmers)
				0.2	0	0	0.2	0.1	0.1	

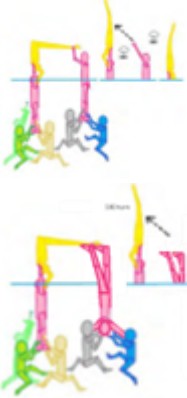



9		<p>“Transitional Stack”</p> <p>(Any 2-stack formation #3-2SupU, #4-2SupD, #5-2SupM, #6-2SupD2F) with disconnection</p>	<b>St&gt;</b>	Hard	Optional	Free body position	1+0.5+0.5	Other	small+bonus -us 0.025 FOR TRANS DIS- CONN- ECT AND BAL- ANCE	<b>1.025</b>
				0.3	0.1	0.1	0.2	0	0.3+ 0.025	
10	 <p>RISKY!</p>	<p>Lift on heads</p> <p>(only on heads. No options as: on 2 head+on 2 shoulders etc. ON HEADS ONLY!)</p>	<b>LH</b>	Hard	no	No	1	type1	med (+0.3 bonus for head connection)	<b>1.00</b>
				0.3	0	0	0.1	0.1	0.2+ 0.3	
11	 <p>RISKY!</p>	<p>Lift on heads +2 f-swimmers</p> <p>(the same “heads rule as in number 10)</p>	<b>Lh2F</b>	Hard	no	No	2	type1	slow-med (+0.3 bonus for head connection)+connect between 2 f.swimmers	<b>1.10</b>
				0.3	0	0	0.2	0.1	0.1 +0.3 +0.1	

**Component D – Direction**

N/A for GROUP B

**Component S – Area of Support / Type of Connection**

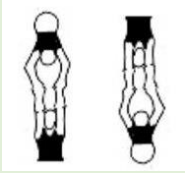
- Every handstand type of connection (PP,1P1P, Px1P, PF, 1P1F, PF\*) must be performed with straight arms from beginning to the end (submergence of the support swimmer) of the acrobatic movement unless otherwise specified in the description of the grip.
- This applies for both the featured-swimmer and the support-swimmer, with the limit of the **head** (specifically defined as the “face”) as the allowance for any slight bending of the arms. **The arms are not allowed to be bent with palms lower than the face (face = from top of the head-until chin level).**
- \*In case of PF – the support swimmer has straight legs and any bending of the legs of the support swimmer is an execution issue
- Arm/s of the support-swimmer must remain within vertical cone ie. 45 degrees (the same rule applies for group C). The same rules for support-swimmers’ arms positioning also applies to types of connection: FP, FPx, 1F1P

Ok	
BM	

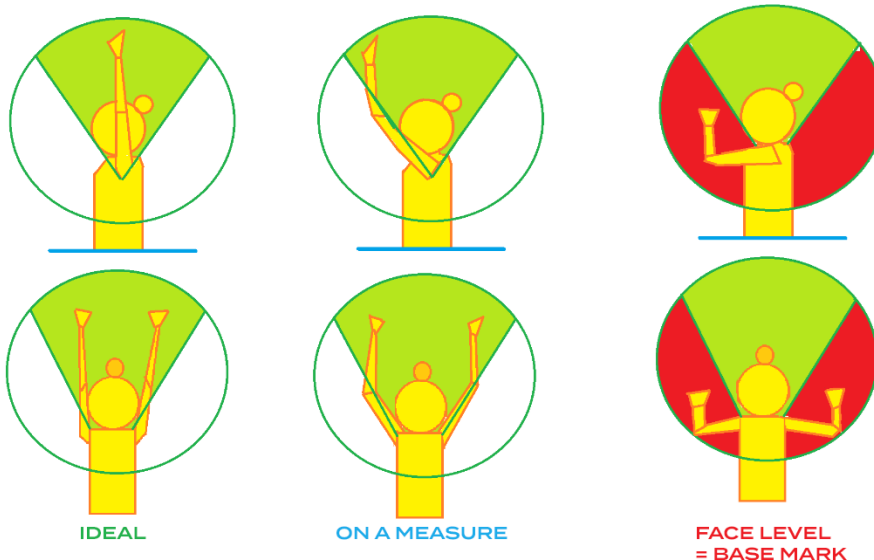







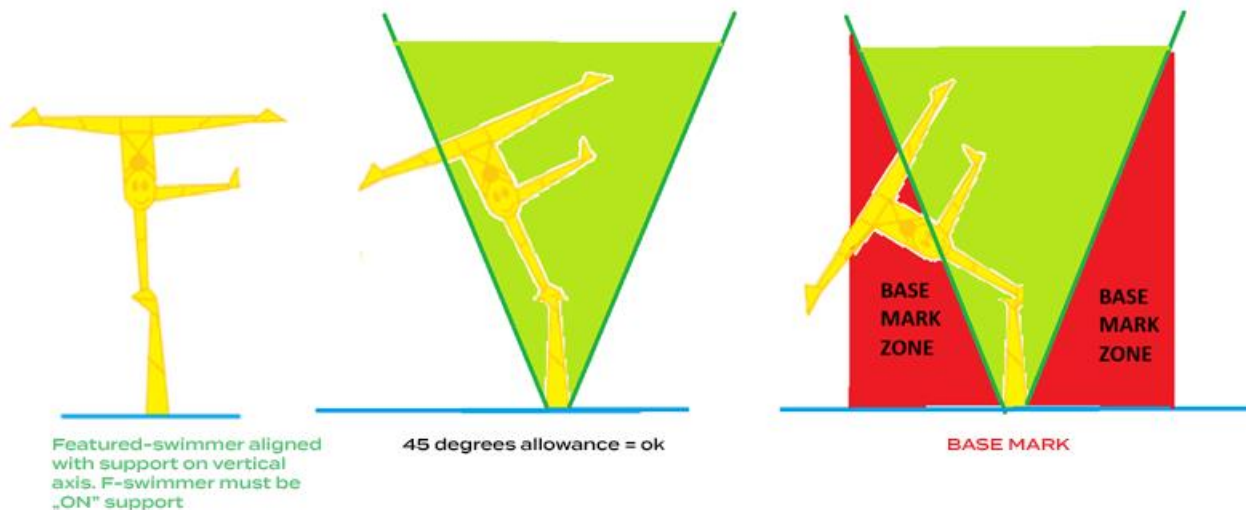

- A **handstand** is the act of supporting the body in a stable, inverted vertical position by balancing on the hands. In a basic handstand, the body is held straight with the arms (close to the ears) with legs fully extended and together, and the hands spaced approximately shoulder-width apart. There are many variations of handstands, all of which require the performer to possess adequate balance and upper body strength.
- When the featured-swimmer with support-swimmer perform 2 types of connection/grips (for example: PP and then Px1P) – you must declare the first one (in our example below it will be PP).
- In handstands in groups B and C when there's a balance in handstand on both or one arm, the featured-swimmer needs to be aligned with the support-swimmer on the vertical axis until submergence with an allowance of 45 degrees from the vertical axis (invisible vertical line that runs through the middle of the bodies of the support and featured-swimmer). The 45-degree cone has a start point at the water's surface from the support-swimmer (and also while the construction is turning). The featured-swimmer must always remain "on" the support.
- **Note:** this rule regarding handstands also applies for Group C bonuses "**Jump**" and "**On1Foot**"



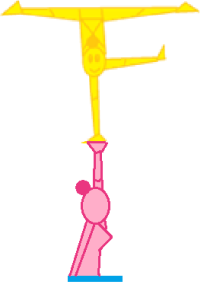

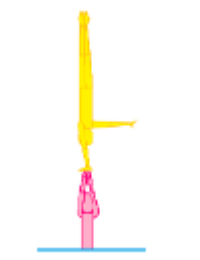
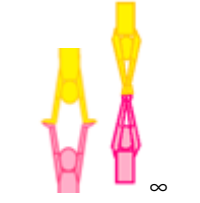
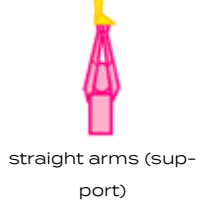

- If you see a symbol ∞ near the picture of the grip – it may be used for the acrobatic movement with the construction "Transitional Stack" (St>) with specified types of connections in group B.



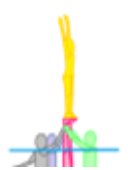
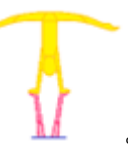

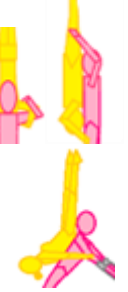

Area of support - Group B									
No.	Picture	Type of Connection	Area of both Supports	Support	Featured-Swimmer	Average	Capture	Bonus/Deduction	Total
1	 straight arms (both)	1 palm on 1 palm  Extra small + Extra small  <b>1P1P</b>	Extra small  +  Extra small	1.2 (average for both)			Capture	0.3 - Vertical body on palm  -0.2 for stabilization catch un support arm	<b>1.30</b>
2		<b>Featured swimmer stand by foot on 1 palm of the support swimmer</b>  <b>1P1F</b>	Extra small+ small	1.2	0.5	0.85	yes	+0.2 ALL BODY ON 1 PALM	<b>1.05</b>
3	 straight arms (both)	<b>Featured swimmer balances on 1 palm on the "XS" type of grip of the support swimmer</b>  <b>Px1P</b>	Extra small  +  Extra small	0.6	1.2	0.9	Capture	0.2 Vertical body on palms!	<b>1.10</b>
4	 straight arms (both)	Palms / palms  <b>PP</b>	Extra small  +  Extra small	0.6	0.6	0.6	Capture	0.2 Vertical body on palms	<b>0.80</b>
5	 straight arms (support)	Feet (featured-swimmer) on palms (support) XS  <b>FPx</b>	Extra small  +  small	0.6	0.5	0.55	Capture	+0.15 for power press	<b>0.70</b>
6	 straight arms (support)	Feet (featured-swimmer) on palms (support)  <b>FP</b>	Extra small  +  small	0.6	0.5	0.55	Capture	+0.15 for power press	



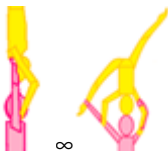

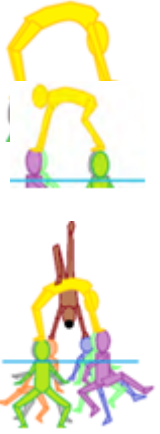
7		Feet (featured-swimmer) on feet (support)  <b>FF</b>	Small + small	0.5	0.5	0.5	No capture!	+0.1 no hand connection between supporters and featured-swimmer  (if in construction there is no «spotters»)	<b>0.6</b>
8		Feet (featured-swimmer) on feet (support) with spotter/s  <b>FF/</b>	Small + small	0.5	0.5	0.5	No capture!	-0.15 for additional spotters help on side	<b>0.35</b>
9		Palms (featured-swimmer) on feet (support)  <b>PF</b>	Extra small + small	0.6	0.5	0.55	Capture	- 0.1 for capture with support	<b>0.45</b>
10		Lower back touch shoulder blades OF THE SUPPORT (blind connection)  <b>Sisb</b>	Small + medium	0.5	0.3	0.4	Capture	Minus 0.1 for capture and minus 0.1 for close to support but +0.2 (for blind connection)  Touch (not «sit») +0.1	<b>0.5</b>
11		«Backpack» grip: Back-to-back blind connection  <b>Bp</b>	Big + Big	0.1	0.1	0.1	Capture	0.2 (for blind connection) - 0.15 for strong «double» hand connection between 2	<b>0.15</b>
12		Shoulders (featured-swimmer) on feet  <b>ShF</b>	Small + medium	0.5	0.3	0.4	Capture		<b>0.40</b>



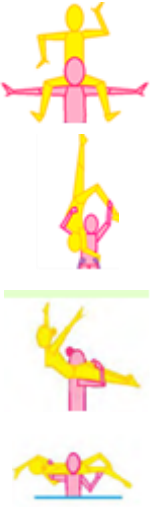

13		<p>"Eiffel" grip: Palms on shoulders/ palms on shoulders (it's not a handstand!)</p> <p><b>E</b></p>	<p>Me- dium/Small+M edium/ small</p>	<p>0.5 0.3</p>	<p>0.5 0.3</p>	<p>0.4</p>	<p>Capture</p>	<p>-0.05 close to center of mass</p>	<p><b>0.35</b></p>
14		<p>Palm (featured swimmer) on head (support) + palm / palm</p> <p><b>PH/</b></p>	<p>Extra small + extra small + help</p>	<p>0.6</p>	<p>0.60</p>	<p>0.6</p>	<p>Capture</p>	<p>Plus connection head 0.15  0.3- all body on palms</p>	<p><b>1.05</b></p>
15		<p>Lift on 2-4 heads of base-swimmers</p> <p><b>LIH</b></p>	<p>4 medium supports = big sustainability</p>	<p>0.1</p>	<p>0.1</p>	<p>0.1</p>	<p>Capture</p>	<p>0.2 bonus for head connection</p>	<p><b>0.30</b></p>
16		<p>All featured-swimmer's body on palms (lay or sit)</p> <p>May have additional connection to support</p> <p>Note: support -swimmer's arms ABOVE or on a same level with head!</p> <p><b>AP</b></p>	<p>Extra small + big</p>	<p>0.6</p>	<p>0.1</p>	<p>0.35</p>	<p>Capture (close to support center of mass)</p>	<p>Bonus 0.1 all body on palms; (close to support center of mass) (-0.1)</p>	<p><b>0.35</b></p>







17		<p>Sit or lay on shoulders</p> <p><b>sis</b></p>	<p>Medium</p> <p>+</p> <p>big</p>	0.3	0.1	0.2		<p>(close to support center of mass) (-0.1)</p>	<b>0.10</b>
18		<p>Feet (featured-swimmer) on shoulders (support)</p> <p><b>FS</b></p>	<p>Medium</p> <p>+</p> <p>small</p>	0.3	0.5	0.4	<p>Capture by support</p>	<p>-0.3 (for 2 hand capture by support) -0.15 for Stable, not risk connect -stabilization balance (divide by 2)</p>	<b>0.025</b>
19		<p>Foot on a shoulder + can have connection with support athlete</p> <p><b>F1S</b></p>	<p>Medium</p> <p>+</p> <p>Small</p>	0.3	0.5	0.4	<p>Extra help from support</p>	<p>minus 0.3 for extra support (2 hands+leg sometimes)</p>	<b>0.10</b>







20		<p>"Lemur" grip</p> <p>Construction</p> <p>2 support athletes with at least 1 head-up. Featured-swimmer lays, stands, hangs, sits on their hands or in a head-down position (or featured swimmer holds the shoulders of one of the supports)</p> <p><b>Le</b></p>	<p>Big + small</p>	0.1	0.5	0.3	Capture	Minus 0.15 for 2 supports	<b>0.15</b>
21		<p>"Tower" grip</p> <p>Construction</p> <p>2 support athletes head-down, f-swimmer lay, stand, hang, sit on their hands or in a head-down position</p> <p><b>Tow</b></p>	medium + medium	0.3	0.3	0.3		<p>Minus 0.2 for capture</p> <p>+0.025 for feet connect</p>	<b>0.125</b>
22		<p>Simple lift (base athletes hold featured-swimmer)</p> <p>Or</p> <p>"Full body" Lift on hands</p> <p>Note: featured-swimmer may support on head/s of the base-swimmers/ spotters</p> <p><b>Li</b></p>	<p>Small + big</p>	0.5	0.1	0.3	Capture	-0.2 (for 3 or more hands capture by base-swimmers; stable)	<b>0.10</b>

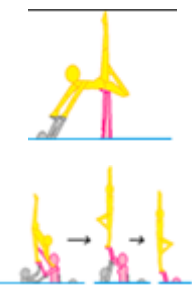

23		<p>"Chameleon" grip</p> <p>Construction 2 supports, one of them h-down; featured-swimmer connects to them by stomach, hands and legs (3points)</p> <p><b>Ch</b></p>	<p>Medium+medium+Small+Small = average</p>	<p>0.3 0.3</p>	<p>0.5 0.5</p>	<p>0.4</p>	<p>Capture</p>	<p>Minus 0.2 for 2 supports</p>	<p><b>0.30</b></p>
24		<p>Twins</p> <p>Featured-swimmer holds the stomach of support and support holds the pelvis of featured-swimmer Or Featured-swimmer holds the shoulders of the spotter and support holds the pelvis of featured-swimmer</p> <p><b>Tw</b></p>	<p>Big + big</p>	<p>0.1</p>	<p>0.1</p>	<p>0.1</p>	<p>Capture</p>		<p><b>0.10</b></p>
25		<p>Lay/Hang on Feet</p> <p><b>LayF</b></p>	<p>Small+ Big</p>	<p>0.5</p>	<p>0.1</p>	<p>0.3</p>		<p>-0.15 close to the support (center of mass lays exactly on support)</p>	<p><b>0.15</b></p>
26		<p>Sit on feet or 1 foot of the support-swimmer</p> <p><b>SiF</b></p>	<p>Extra small</p>	<p>Med</p>	<p>0.35</p>			<p>-0.1 for center of mass close to support</p>	<p><b>0.20</b></p>
			<p>0.5</p>	<p>0.2</p>				<p>-0.05 for stability catch</p>	
27		<p>Construction</p> <p>2 support athletes head-up, featured-swimmer 1 leg stays on a head of first support and 2<sup>nd</sup> leg on palms (near head)</p> <p><b>1FH+1FP</b></p>	<p>Small+ extra small + Extra small + Small+ help</p>	<p>0.5</p>	<p>0.6</p>	<p>0.55</p>	<p>Capture</p>	<p>Plus connection head 0.2 Minus -0.2 for 2 supports</p>	<p><b>0.55</b></p>

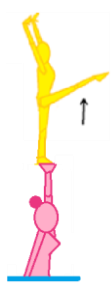





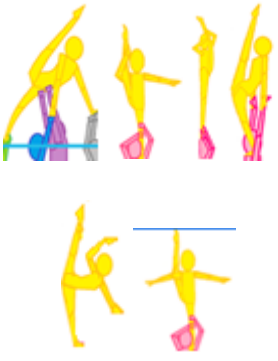

28		Sit, stand or lay on Stack or Stack head-down+ spotter/s  <b>S+</b>	Small+ Big	0.5	0.1	0.3		-0.25 for spotters	<b>0.05</b>
									
29		1 foot on 1 palm  <b>1F1P</b>	Small+ extra small	1.2	0.6	0.85	yes	+0.4 ALL BODY ON 1 PALM	<b>1.25</b>
30		1 foot on 1 foot  <b>1F1F</b>  Leg of the support-swimmer on which featured-swimmer balances must be straight. The leg on which featured-swimmer stands must be straight.	Small+small	0.5	0.5	0.5		Bonus for no connect 0.1  1 body part multiply on 2	<b>1.10</b>





**Component P – Position**
**Group B Positions**

No.	Picture	Name and code	Vesti-bu-lar load/ Difficulty to bal- ance	Presence or absence of a helping hand (capture)	Type and level of flexibility+ Devia- tion of torso from inner axis	Total	Value If Position 2	Code for position 2 (level)
Stand on 1 Leg								
Forwards/Sideways								
1		Heron	Stand on 1 leg	Can be with or without capture	Leg (thigh) 90	<b>0.10</b>	0.05	<b>2he</b>
		he	can be with arch in back	0.075	0			
2	 <p style="text-align: center;">both legs straight</p>	Vertical Split	Stand on 1 leg	Can be with or without capture	Fold (leg forwards or sideways 180)	<b>0.30</b>	0.10	<b>2vs</b>
		vs		0.075	0			



3		Glass	Stand on 1 leg	Yes (opposite arm behind head!) or 2 hands one of them behind head or in line with head	Misc (side 180)	<b>0.40</b>	0.20	<b>2gl</b>	
		<b>gl</b>		0.075	0.025				0.3
Backwards (Positions in this subgroup must differentiate from positions "sideways". We need to see hips square, and leg moves backwards!)									
4	 	Ballerina	Stand on 1 leg	Can be with or without capture	Arch (leg back 90 degrees and more) May have torso forwards	<b>0.10</b>	0.05	<b>2ba</b>	
		<b>ba</b>		0.075	0				0.025
		can lean forward							
5		Sail	Stand on 1 leg	Must have leg capture (any arm)	Arch (leg back 90 degrees and more) must have torso forward 90 degrees	<b>0.25</b>	0.10	<b>2sa</b>	
		<b>sa</b>		0.075	0.025				0.15
		Must have leg capture (any arm)							
6	 	Needle	Stand on 1 leg	Can be with or without capture (needle special)	Arch (torso forward 90 or more+180 degrees between legs (both straight))	<b>0.40</b>	0.20	<b>2ne</b>	
		<b>ne</b>		0.075	0.1				0.225







7	 <p>Blind capture required or opposite arm capture (elbow/s look forward - not a "side" capture!) Leg can be on a shoulder</p>	Eye	Stand on 1 leg	Yes + blind grip moving leg or opposite arm capture	Leg backward 135 (0.25) + torso forward 45 (0.1)	<b>0.50</b>	0.25	<b>2ey</b>	
		ey	0.075	0.2	0.225				
Stand on 2 Legs									
8		Stand	no	-	Can have an arch in back	<b>basic 0.05</b>	0.025	<b>2sd</b>	
		sd	o	o	0.05				

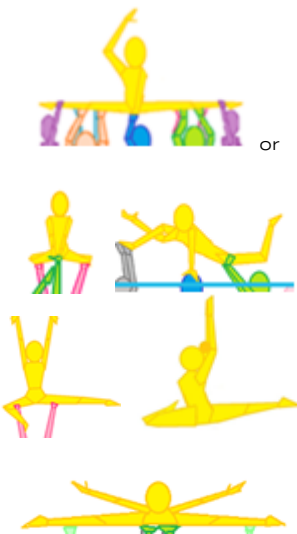

Sit or Lay or Stand (on all 4 or 3)								
9		<p>Monkey</p> <p><b>mo</b></p>	<p>Sit/Lay/stand</p>	<p>Can be with or without capture</p>	<p>Basic. Free positions where legs are close to centre of mass (ie. Tuck variations, sit positions etc)</p>	<p><b>0.10</b></p>	<p>0.05</p>	<p><b>2mo</b></p>
			<p>0.05</p>	<p>0</p>	<p>0.05</p>			
10	<p>Legs straight and torso touches legs</p>	<p>Shrimp</p> <p><b>sh</b></p>	<p>Sit/Lay/stand</p>	<p>Can be with or without capture</p>	<p>Both legs straight can be together or spread. Torso touch legs (legs are within 45 degrees of the torso incl. the allowance)</p>	<p><b>0.125</b></p>	<p>0.0625</p>	<p><b>2sh</b></p>
			<p>0.05</p>	<p>0</p>	<p>0.075</p>			

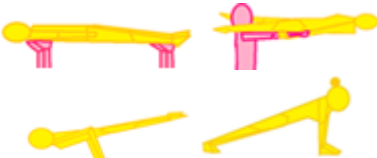



11		Split	Sit/Lay/st and	Can be with or without capture	(90 side + 90 side or Front split) 0.05.	<b>0.30</b>	0.15	<b>2spl</b>
		<b>spl</b>			must have from knee-to knee alignment of 180 degrees with 45 degrees allowance Leg/s might be bent.			
12	 <p>Blind capture required</p>	Harp	Sit/Lay/st and	Must have blind or opposite arm capture	Must be an extension between thighs *from knee to knee* 180. Leg/s might be bent.	<b>0.50</b>	0.25	<b>2hp</b>
		<b>hp</b>			0.05			
13	 <p>Can be also on stomach or on the side</p>	Scissors	Sit/Lay/st and	-	Straight aligned body	<b>0.1</b>	0.05	<b>2sc</b>
		<b>sc</b>			0.05			
14		Cobra	Sit/Lay/st and	-	Straight body +arching up-to 90 degrees	<b>0.15</b>	0.075	<b>2co</b>
		<b>co</b>			0.05			

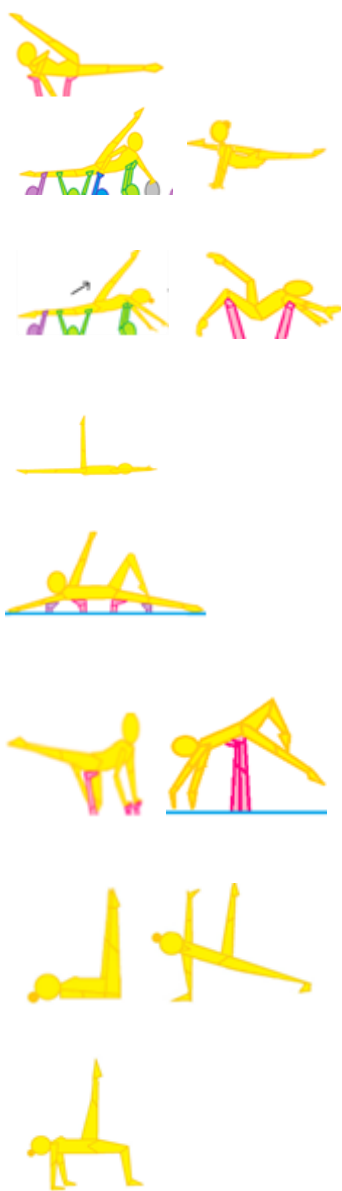

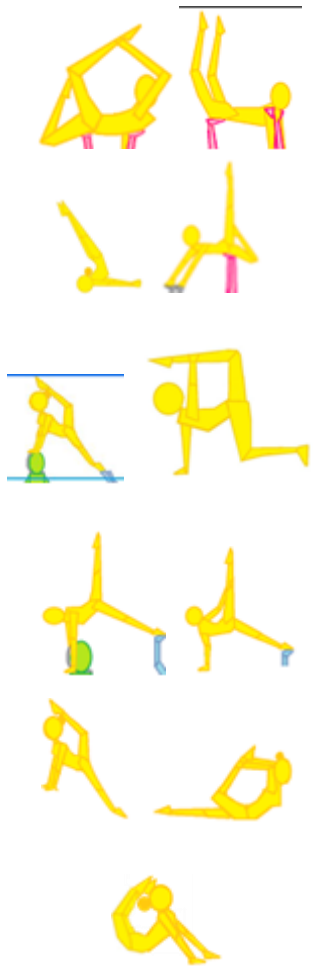

15		Flamingo	Sit/Lay/st and	Can be with or without capture	Str body +90 (1 or 2 legs bent or straight) and more sideway or for- ward	<b>0.25</b>	<i>0.125</i>	<b>2fl</b>
			<b>fl</b>	0.05	0			



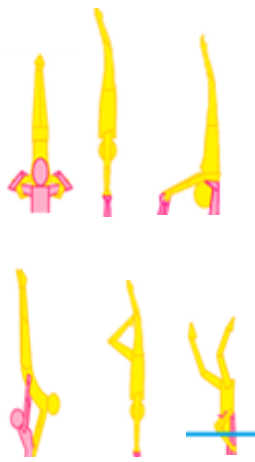

16		Scorpio	Lay/sit HEAD-UP or head in line with torso/ stand	Can be with or without capture	Str body +leg/s Arch back- ward, 90+	<b>0.25</b>	0.125	<b>2so</b>
		<b>so</b>	0.05	0	0.2			
17	 <p>Blind capture with 2 legs and 2 arms</p>	Turtle	Lay	Yes (Blind capture with 2 legs and 2 arms)	Arch In back	<b>0.35</b>	0.175	<b>2tu</b>
		<b>tu</b>	0.05	0.15	0.15			
18	 <p>Blind capture with 1 leg and 2 arms or with opposite arm</p>	Pin	Lay	Yes 2 arms blind capture or opposite arm	180 between straight legs+ arch in back	<b>0.6</b>	0.3	<b>2pi</b>
		<b>pi</b>	0.05	0.20	0.35			





Head-Down								
19		Bamboo	Head-down	-	Basic (straight)  Allowed: small arch or variation of the legs in 45 degrees from vertical =inside/within vertical cone	<b>0.15</b>	<i>0.075</i>	<b>2bb</b>
		<b>bb</b>	Can be on 1 hand	0.1	0			
20		Box	Head-down	-	Legs forwards or sideways. Everything between split and 45 degrees from vertical line. Legs can be straight, bent or both.	<b>0.25</b>	<i>0.125</i>	<b>2bo</b>
		<b>Bo</b>	Can be on 1 hand	0.1	0			





21		Willow	Laying/ Head- down	May have capture	90 degrees back arch	<b>0.275</b>	<i>0.1375</i>	<b>2wi</b>
		<b>wi</b>	Can be on 1 hand	0.15	0			
22	 <p>Must have from knee-to-knee alignment of 180 degrees with 45-degree allowance</p>	Owl	Head- down	May have hand capture	Leg forward 90+back 90 or both legs 90 de- grees sideways	<b>0.3</b>	<i>0.175</i>	<b>2ow</b>
		<b>ow</b>	(Any split head-down)  Can be on 1 hand	0.15	0			



Extreme Flexibility (For Advanced Level) Warning/Caution - very risky - May cause injury!								
23	 Blind capture with 2 arms	Drop	Head-down Stand on 2 legs!	Yes (blind capture with 2 arms)	Arch (back almost 180)	<b>0.55</b>	0.275	<b>2dr</b>
		<b>dr</b>	0.15	0.2	0.2			
24	 Blind capture with 2 arms or opposite arm	Queen	Head-down+ Stand on 1 leg	Yes (blind capture with 2 arms or opposite arm)	Arch (back almost 180)+1 must have from knee-to knee alignment of 180 degrees with. Legs straight	<b>1.00</b>	0.50	<b>2qu</b>
		<b>qu</b>	0.25	0.2	0.55			

**Component R – Rotation of the Construction Base**

We start counting the rotation of the support-swimmer (ie. Stack or Stack head-down) when the support-swimmer starts turning. Sometimes you can see that the turning starts from underwater while rising and the featured-swimmer lifts her/his leg while the turn is already happening – it's not BM.

Values of the Construction Base in group B						
Type	Degree of rotation					
	90°	180°	360°	540°	720°	To be used with these type of connections
Value* for Stack where:  <b>The support-swimmer is head up and the legs of the featured-swimmer are not at 135-180 degrees throughout the rotation.</b>  *Support-swimmer with featured-swimmer on top rotates on the vertical axis.  OR  <b>In 2 Support construction (# 3 ie.2SupU), one of the supports twirls (or turns more than 180) and featured-swimmer remains connected to both support-swimmers while one of them is rotating.</b>	-	<b>r0.5</b>	<b>r1</b>	<b>r1.5</b>	-	#5 - FPx #6 - FP #10 - SiSb #11 - Bp #13 - E #16 - AP #17 - SiS #19 - F1S #24 - Tw #28 - S+ And possible: #29 (1F1P) and #30 (1F1F)
Value* for Stack where the <b>featured-swimmer stands on 2 feet on the shoulders of the support-swimmer.</b>  *Support-swimmer with featured-swimmer on top rotates on the vertical axis.		<b>r0.5/</b>	<b>r1/</b>	<b>r1.5/</b>	-	FS connection (#18)
		<b>0.05</b>	<b>0.10</b>	<b>0.15</b>		



<p>Value* for Stack head-up where <b>featured-swimmer stands on 1 leg and other one is at 135 to 180 degrees.</b></p> <p>Note: the position must be maintained through the whole rotation of the construction (or position 2 must be with equal "leg-position" degree (135-180) to first position (ie Eye, Needle, Sail, Vertical Split to Glass etc).</p> <p>*Support-swimmer with featured-swimmer on top rotates on the vertical axis.</p>	-	r0.5+	r1+	r1.5+	r2+	<p>To be used with connections:</p> <p>#19 – F1S #5 – FPx #6 – FP</p> <p>Possible: #29 (1F1P) and 30 (1F1F) only if the leg remains through rotation in 135–180-degree for all 2 or more positions</p>
<p>Value* for Stack where <b>featured-swimmer is in "Handstand" connections categories.</b></p> <p>OR</p> <p>Value for Stack when <b>Support-swimmer is head-down</b></p> <p>*Support-swimmer with featured-swimmer on top rotates on the vertical axis.</p>		0.125	0.225	0.325	0.425	
<p>Value for Lift</p> <p>Big water resistance for base athletes while <b>all construction</b> rotates including base-swimmers.</p> <p>Rotation starts from the surface, not from underwater.</p> <p>Note: the same rotation of the construction is possible to happen in group C, while main featured-swimmer fly above rotating lift. In this case TC must see arms of base-swimmers and identify a turn (TC must that the whole formation turns)</p>	r/L	r0.5L	r1L	-	-	<p>To be used with connections:</p> <p>#15 – LiH #22 – Li</p>
	0.40	0.50	0.80			



<p><b>Notes:</b></p> <p>The direction (left or right) of the construction's base rotation does not influence the value.</p> <p>For the moment, for the grips 20 (Le), 21 (Tow), 23 (Ch) there's no rotation of the construction. In the case where only featured-swimmer rotates without the support-swimmer (for example around self while submerging) you can declare a twirl bonus ie. <b>"Twirl"</b></p> <p><u>Notes for the TC:</u></p> <p>*When rotation of the Stack or Stack head-down is declared TCs should look at the turning of the support-swimmer to ensure it is a rotation of the construction base, in addition to the featured swimmer completing the declared rotation until the allowance</p> <p>*If the support-swimmer is submerged, but you can clearly see that the turning continues – look at the featured-swimmer and make sure the required number of rotations are completed until the allowance (it must not look like a turn of only the featured-swimmer on their own – not connected to the support)</p> <p>*If the ability of execution is low in height and TCs can't see the support swimmer, TCs should look at the featured-swimmer as per above.</p>	
--	---

**Component T – Plane and Degree of Rotations**

N/A for GROUP B

**Component B – Bonus**

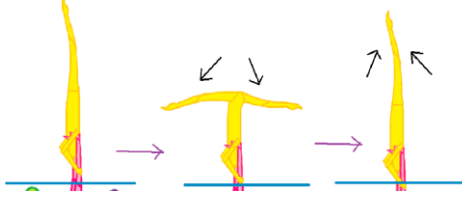
List of additions, bonuses, and risk-elements in Group B			
Code	For Group B		Value
<b>Db1</b>	<b>Synchronized actions for double acrobatic movements</b>		<b>0.20</b>
<b>Pos3</b>	<p style="text-align: center;"><b>Third position</b></p> <p>Example: at the end of acrobatic movement closing legs from split to vertical or tucking (any additional position 3rd, 4th, 5th etc.).</p> <p>This bonus should be declared only once no matter how many positions featured-swimmer will perform after the first 2 declared ones.</p>		<b>0.05</b>



Can't be in same acro!	<b>Twirl</b>	<p><b>"Twirl"</b> of featured-swimmer in group B 180-360 (head-up or head-down).</p> <p>Support-swimmer does not move. Featured-swimmer turns to opposite direction (like in 2-direction twist) if head-down) or rotates on feet or palms of the support (if head-up). <u>Only the featured-swimmer rotates</u>, all other/s (support or base-swimmer/s) <u>stay static</u> (movement is like a ballet dancer on their "pointe shoe")</p>	<p>twirl of the body 180</p>	<b>0.10</b>
	<b>RotF</b>	<p>Featured-swimmer <b>rotates on feet</b> of support 180-360°</p> <p>The support-swimmer remains in their position (Support remains static!) but the featured-swimmer rotates on their feet without leaving the support <b>in horizontal plane</b>.</p> <p>It is <u>NOT</u> rotation of the construction. Featured-swimmer can be on stomach or on a back.</p>		<b>0.10</b>
<b>Hold</b>	<p style="text-align: center;"><b>Long holding lift</b> (3 seconds and more)</p> <p>Time starts when featured-swimmer achieves maximum height and ends when featured-swimmer starts submerging</p> <p>When you have rotation of the construction or bonus for moving base lift you can't declare Hold bonus unless it happens separately – ie you complete Hold and then do a rotation or "Mov"</p> <p>Can't be declared at the same time with "Mov" or "Moon" bonus</p>		<b>0.50</b>	
<b>SdUp</b>	<p style="text-align: center;"><b>Stand-up</b></p> <p>(lifting torso) from head-down position</p> <p>Example: Needle to Heron</p>		<b>0.10</b>	
<b>Moon</b>	<p><b>"Moonwalk"</b>: Lift-up from split, legs sliding and changing place and opening back to the split on surface</p> <p>Base-swimmers hold legs of featured-swimmer and move underwater to change position of the featured-swimmer. It can either be move of 1 leg, other remains static or moving both legs at the same time. Legs move forwards/backwards.</p>		<b>0.25</b>	



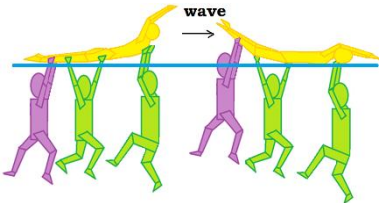
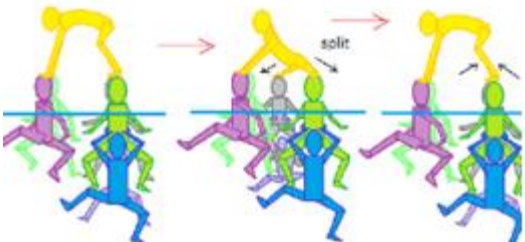





<b>Wave</b>	<p><b>“Wave”</b> movements (featured-swimmer/s must be lifted away from surface)</p>		<b>0.10</b>
<b>Mov</b>	<p><b>Moving base lift</b> (base-swimmers move backward and then return)  OR  Moving base lift (base-swimmers pass through each-other (under featured-swimmer)</p>		<b>0.30</b>

**29.7.1.5 Group P**
**Component C – Construction**



Any construction in group P can be lifted from underwater or starts at the surface. The ending of a platform can be done with the descent of the construction or as a “regroup” action on a surface (for example featured-swimmer dives away from platform and support-swimmer make a kick while base-swimmers stop holding him/her and continue the routine).

No.	Picture	Name and number of levels	Difficulty of coordinating actions and number formations	Support: Body position and level of sustainability	Support: Type and level of flexibility or maintain position	Air-borne weight	Area of full construction, Proximity between swimmers	Tempo of acceleration and push (lift/throw)	TOTAL
1	  	Platform (Support straight body) Or with bent knees Or Box construction  <b>P</b>	Hard	High level of sustainability+ low vestibular load (laying)	straight body	2+ may have bent knees	Type 2	slow-med	<b>1.00</b>
		0.3	0.1	0.1	0.2	0.2	0.1		
2A		Straight body with bent knees  <b>Knees</b>	Hard	High level of sustainability+ low vestibular load (laying)	straight body	2+ may have bent knees	Type 2	slow-med	<b>1.05</b>
			0.3	0.1	0.1	0.25	0.2	0.1	



2		Platform (Support Ballet Leg) <b>B</b>	Hard	High level of sustainability+ low vestibular load (laying)	leg forward 90 degrees	2+leg straight	Type 2:	slow-med	<b>1.20</b>
			0.3	0.1	0.2	0.3	0.2	0.1	
3		Platform (Support Double Ballet Leg) <b>DB</b>	Hard	High level of sustainability+ low vestibular load (laying)	leg forward 90 degrees	2+two legs straight	Type 2:	slow-med	<b>1.30</b>
			0.3	0.1	0.2	0.4	0.2	0.1	
4		Platform (Support on stomach with bent knees) or in arch "Chariot" <b>Chariot</b>	Hard	High level of sustainability+ low vestibular load (laying)	straight body+ bent knees or arch	2	Type 2	med	<b>1.15</b>
			0.3	0.1	0.15	0.2	0.2	0.2	
5	  Important: there <u>MUST</u> be base-swimmers under <u>both</u> support-swimmers.	Platform from 2 supports ( <u>any variations</u> : straight bodies, 1 or 2 Double or Single Ballet Leg or any combination of above) <b>2S</b>	Hard	High level of sustainability+ low vestibular load (laying) 1	static straight body or ballet legs?	3	Type 2	slow-med	<b>1.10</b>
			0.3	0.1	0.1	0.3	0.2	0.1	
 Can be 2 supports in Double Ballet leg									
6		Platform "Flower" (3-7 swimmers form a support from legs) + Others are base-swimmers <b>Flower</b>  Minimum requirement for this acro: 1 base-swimmer+ 3 support-swimmers+ 1 featured-swimmer= total 5 athletes	Med	no	static straight body	4-8	Type 3	-	<b>1.00</b>
			0.1	0	0.1	0.8	0	0	



7	 may or may have not base-swimmers	Platform made from hands	Hard	no	no	1	Type 2	med	<b>0.80</b>
		<b>Hand</b> Important may or may have not base-swimmers	0.3	0	0	0.1	0.2	0.2	
8		Platform 4 levels	Very-Hard	High level of sustainability+ low vestibular load (laying)	straight body	3	Type 2	slow-med	<b>1.20</b>
		<b>P4</b> (4 levels!)	0.4	0.1	0.1	0.3	0.2	0.1	

**Component D – Direction**



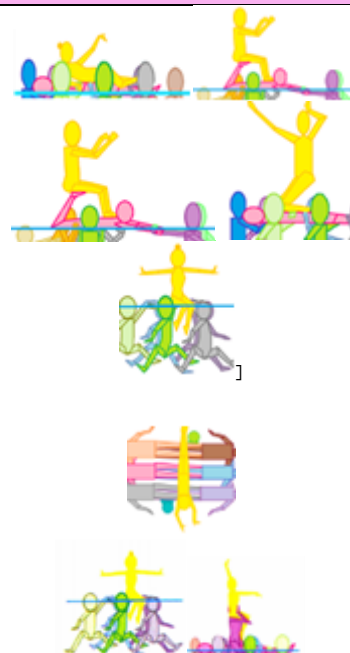

N/A for GROUP P

**Component S – Area of Support / Type of Connection**
**Area of support – Group P**







No.	Picture	Type of Connection	Support	Featured Swimmer	Average	Capture (support/ base holds f.swimmer)	Bonus/ Deduction	Total
1		Sit or Lay on straight body also apply: (Sit, Lay, Head-down or stand) on Flower construction	Big	Big (legs)		Doesn't matter (can be)	-0.05 to close to support	<b>0.05</b>
		<b>SiA</b>	0.1	0.1	0.1			



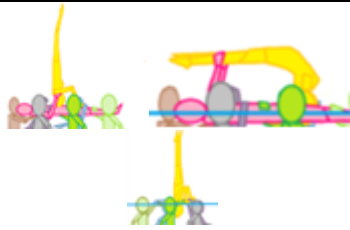

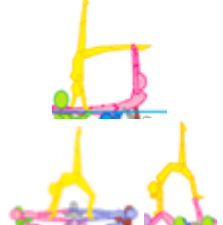





2		<p>Stand (two legs, feet) on straight or arched body or hands or ballet leg/s</p> <p><b>F2A</b></p>	Big	Medium (2 feet)		Doesn't matter (can be)		<b>0.20</b>
			0.1	0.3	0.2			
3		<p>Stand (two legs, or 1 foot) on straight or arched body or hands or ballet leg/s+ blind connect to support</p> <p><b>FAb</b></p>	Big	Medium (2 feet)		Yes	+blind	<b>0.30</b>
			0.10	0.30	0.20	-0.10	0.2	
4		<p>3 POINTS (Stand 1 leg + 2 hands) on straight body/s Or (Stand on 1 leg+ palms/palms connection)</p> <p><b>3pA</b></p> <p>(can have additional help from base-swimmers)</p>	Big	Extra small + small (1 foot)		Doesn't matter (can be)	-0,15 connect to sup	<b>0.15</b>
			0.1	0.4	0.3			
5		<p>Stand 1 leg on straight body or hands or shoulder</p> <p><b>1FA</b></p>	Big	Extra small (1 foot)		Doesn't matter (can be)		<b>0.40</b>
			0.1	0.7	0.4			





6		Headstand on straight body or Head between legs or Head between hands	Big	Small (head)		Doesn't matter (can be)	Centre of mass close to support	<b>0.10</b>
		<b>HA</b>	0.1	0.5	0.3		- 0.2	
7		Shoulders on palms + connect or touch (lay) on bent knees	Small + extra small	Medium (shoulders)		Yes		<b>0.25</b>
		<b>SP+K</b>	0.4	0.3	0.35	- 0.1		
8		Any 3-point connection with straight body bent knees	Small	Extra small + small (1 leg/knee)		Yes		<b>0.35</b>
		<b>3pK</b>	0.5	0.4	0.45	- 0.1		
9		3 points of support blind connect	Big	Extra small+big		Doesn't matter (can be)	+blind	<b>0.40</b>
		<b>3pb</b>	0.1	0.6	0.3		+0.1	
10		Foot on a ballet leg body + palm/foot (can have additional support with another Ballet.leg/s)	medium	small (1 foot and 1 palm)		Yes	-0.05 for stability	<b>0.25</b>
		<b>FA+PF</b>	0.3	0.5	0.4	-0.1		
11		Shoulders on palms + connect with leg or 2 legs	Extra small	Medium (shoulders)		Yes	-0.05 for stability	<b>0.35</b>
		<b>SP+L</b>	0.7	0.3	0.5	- 0.1		
12		Sit on feet or 1 foot+ blind palms/palms	Medium	Medium			+ blind +0.05 for connection	<b>0.35</b>
		<b>SiF+Pb</b>	0.3	0.3	0.3		+0.05	



13		Shoulders on feet+ connect to palms	Medium	Small		Yes		<b>0.30</b>
		<b>ShF+P</b>	0.3	0.5	0.4	- 0.1		
14	   	Sit or Lay on feet (or foot) + palms/palms or sit/lay on feet/foot +shoul- ders/ palms con- nection	Small	Medium (bottom or lower stom- ach)		Yes		<b>0.30</b>
		<b>L/SiF+P</b>	0.5	0.3	0.4	-0.1		
15		4 points of con- nection	Medium	Medium (shins)		Yes (double)		<b>0.10</b>
		<b>4p</b>	0.3	0.3	0.3	-0.2		
16		Handstand on a big area/s of sup- port (2 palms) Have additional help from base- swimmers	Small	Big				<b>0.275</b>
		<b>2pA</b>	0.5	0.1	0.3		-0.025 for base-swim- mers help	

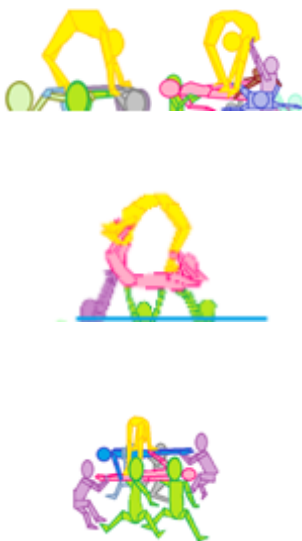

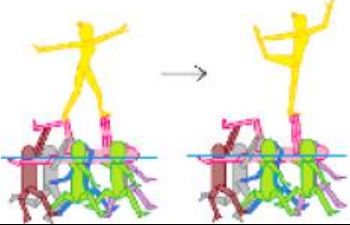
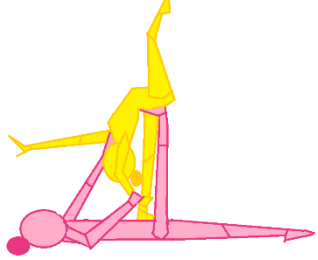
16		Bridge or any 4 "blind" points of support on straight/arched bodies or legs or hand platform (can have extra help from base-swimmers)  <b>4pAb</b>	Big	Small		Doesn't matter (can be)		<b>0.30</b>
			0.1	0.5	0.3			
17		Bridge on a double ballet leg. Featured-swimmer can be facing any way.  <b>Bb</b>	Small	Small		Yes	<b>blind</b>	<b>0.40</b>
			0.5	0.5	0.5	- 0.1	+ 0.1	
18		2 points of support on Knees+ palms  <b>2pK</b>	Small	Medium		Yes (double help)	-	<b>0.20</b>
			0.5	0.3	0.4	- 0.2		
19		Onto 1 foot on Palms  <b>&gt;F1P</b>	Extra*2	Small		Yes	-0.15 for transit	<b>0.60</b>
			1.2	0.5	0.85	-0.1		
20		3 blind point support on 2S  Can be used for construction B  <b>3pBb</b>	Small	Small/ Medium		Yes	+blind arch capture	<b>0.65</b>
			0.5	0.4	0.45	-0.1	+0.3	

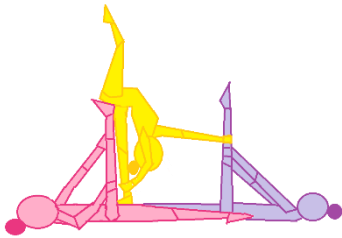
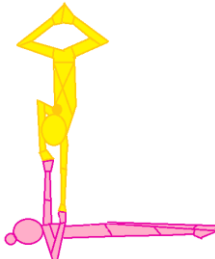
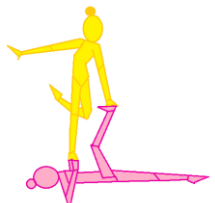
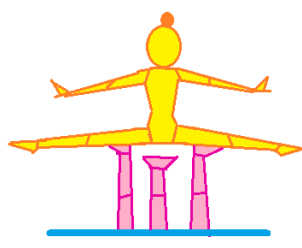
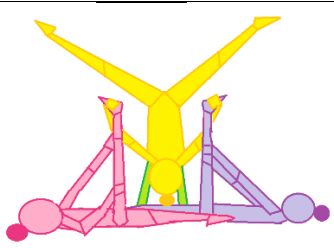

21		3 point support on 2S (construction #5) +connect to ballet leg  <b>3pB+b</b>	Small	Small/ Medium		Yes	blind	<b>0.45</b>
			0.5	0.4	0.45	-0.1	+ 0.1	
22		Featured-swimmer performs 1 arm handstand on a palm of platform with additional connection to support-swimmer (leg)  <b>&gt;1P1P/</b>	Extra*2			Yes	-0.15 for transit	<b>0.65</b>
			1.2		0.9	-0.1		
23		Platform holds a featured-swimmer standing on 1 leg on X-small support - palm to foot  <b>1Fxs/</b>	Extra*2	Small		Yes	Minus for connect to leg	<b>0.55</b>
			1.2	0.5	0.85	-0.1	-0.2	
24		Sit on 2 feet (ballet legs) +extra connect to leg of the support with disconnection  <b>On2b</b>	big	3 feet (small) in average		+dis-connect	Minus for connection to leg in beginning and plus for balance on 2 small areas	<b>0.40</b>
			0.1	0.3	0.2	0.1	-0.1 +0.2	
25		Hanging on 2 ballet legs +help from base  <b>2b/</b>	Extra small	small		Yes	+0.1 for hanging	<b>0.55</b>
			0.6	0.5	0.55	-0.1		

**Component P – Position**

Please use the Position Charts from GROUP B



**Component T – Plane and Degree of Rotations**

N/A for GROUP P



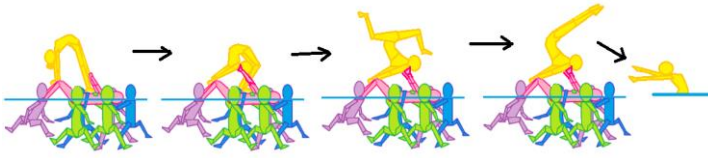

**Component R – Rotation of the Construction Base**

Values for Rotation of the construction base in Group P			
Type	Degree of rotation		
	90°	180°	360°
Value for platform (all construction rotates including base-swimmers) where the <b>featured-swimmer does not sit or lay on construction</b>  The platform is made with a horizontal support-swimmer(s)	<b>Pr</b>	<b>Pr0.5</b>	<b>Pr1</b>
	0.20	0.30	0.40
Value for Platform (all construction rotates including base-swimmers) where the <b>featured-swimmer sits/lays on construction</b>	<b>Pr/</b>	<b>Pr0.5/</b>	<b>Pr1/</b>
	0.05	0.10	0.15
Value for construction <b>made from hands</b> (#7 - Hand)	-	<b>PO.5h</b>	<b>P1h</b>
	-	0.25	0.30
Value for platform made from legs with <b>2 support-swimmers or more</b>  (constructions #5 – 2S, #6 - Flower)	<b>Pr//</b>	<b>Pr0.5//</b>	<b>Pr1//</b>
	0.30	0.40	0.50

**Component B – Bonus**

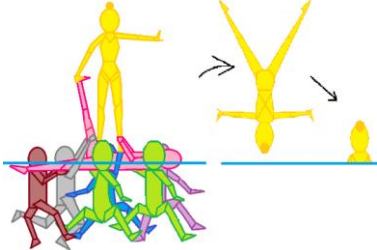
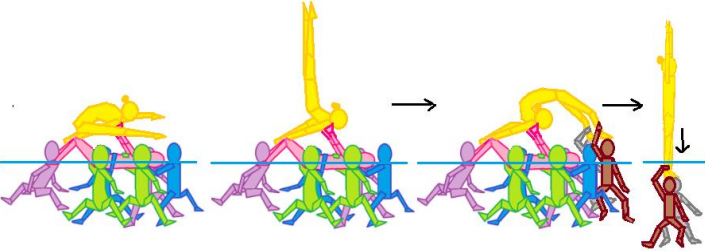
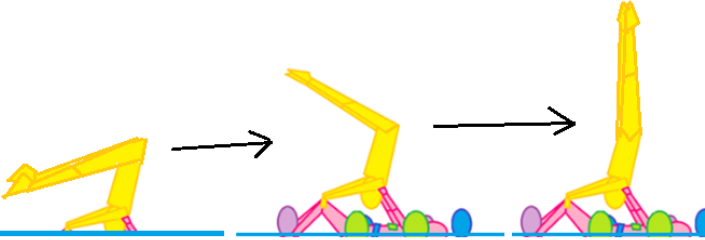
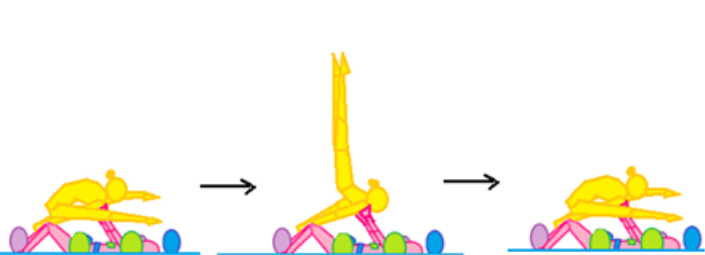
List of additions, bonuses, and risk-elements in group P:			
Code	For Group P		Value
<b>Db1</b>	<p><b>Synchronized actions for double</b> acrobatic movements</p> <p>Can be facing different directions, but must be at the same time and done the same</p>		<b>0.20</b>
<b>Pos3</b>	<p><b>Third position</b></p> <p>Example: at the end of acrobatic movement closing legs from split to vertical or tucking (any additional position 3rd, 4th, 5<sup>th</sup> etc.)</p> <p>This bonus can be declared only once no matter how many positions featured-swimmer will perform after the first 2 declared ones.</p>		<b>0.05</b>
<b>UP</b>	<p><b>Platform made from hands</b>, which are "out of the water" (not on the surface).</p> <p><b>Must hold 3 seconds</b> or more + the whole arm (from shoulder to fingers) = dry</p>		<b>0.30</b>



	<p><b>CH</b></p> <p><b>Cartwheel or Handspring</b> ending action after performing actions on a platform and entering the water</p>		<p><b>0.15</b></p>
	<p><b>MovHead</b></p> <p><b>Move from Platform on to 1 or 2 spotter's heads</b> for finishing acrobatic movement as a Lift</p>		<p><b>0.30</b></p>
<p style="writing-mode: vertical-rl; transform: rotate(180deg);">Cant be in same acro!</p>	<p><b>Porp</b></p> <p><b>"Porpoise"</b> start-action for featured-swimmer at the beginning of the acrobatic movement to get to the main <b>(first)</b> position.</p>	 <p>Porpoise must start in pike position (on a surface or under the water) and finish in Bamboo position to be considered as Bonus. Note: if coach want to do other position as Position 1: featured-swimmer needs to start in this position or go to it "not through Vertical Position (ie. Bamboo)", If coach wants to declare "Box" as position 1: bonus for Porpoise can't be declared, as porpoise require Bamboo to be position 1</p>	<p><b>0.15</b></p>
	<p><b>Spich</b></p> <p><b>"Spichag"</b> power press-up from Shrimp to Bamboo/or in opposite direction: power-lowering from Bamboo to Shrimp.</p> <p>Can be both variants - declare once! Can happen in any phase of acrobatic movement</p>		<p><b>0.50</b></p>
<p><b>Trav</b></p>	<p><b>Travelling construction</b></p> <p>It must be an <u>obvious</u> movement from one spot to another.</p> <p>May start moving from underwater while ascending</p>		<p><b>0.20</b></p>
<p><b>Stand</b></p>	<p><b>After handstand/head-down</b> position/s featured-swimmer lowers legs on a platform and <b>stands-up</b>.</p> <p><b>(For example: from Needle to Stand position, or from owl to Stand position)</b></p>		<p><b>0.10</b></p>



Can't be declared in the same acro! Same allowance rules for somersaults and twists apply in these bonuses	<p><b>Dive</b></p> <p><b>Dive, Dismount or Half Somersault</b> at the end of the platform</p> <p>Featured-swimmer performs a dive, dismount or half somersault (may have twist around self while diving) to enter the water</p>		<p><b>0.05</b></p>
	<p><b>Ps1</b></p> <p>At the end of the platform, the featured-swimmer performs <b>360° somersault</b> to enter the water</p>		<p><b>0.10</b></p>
	<p><b>Ps1t0.5</b></p> <p>At the end of the platform, the featured-swimmer performs <b>360° somersault + half twist</b> to enter the water</p>		<p><b>0.15</b></p>
	<p><b>Ps1top</b></p> <p>At the end of the platform, the featured-swimmer performs <b>360° somersault and open to a straight body position</b> to enter the water</p>		<p><b>0.30</b></p>
	<p><b>Ps1t0.5o</b></p> <p>At the end of the platform, the featured-swimmer performs <b>360° somersault + half twist and open to a straight body position</b> to enter the water</p>		<p><b>0.40</b></p>
	<p><b>Ps1t1</b></p> <p>At the end of the platform, the featured-swimmer performs <b>360° somersault + 1 twist</b> to enter the water</p>		<p><b>0.25</b></p>
	<p><b>CH+</b></p> <p><b>Handspring with connection</b></p>		<p><b>0.20</b></p>



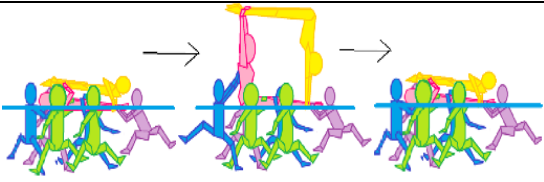
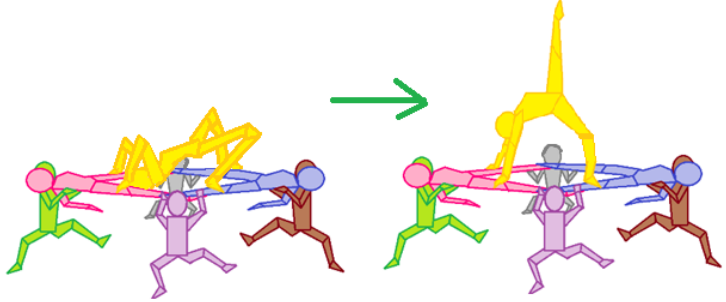
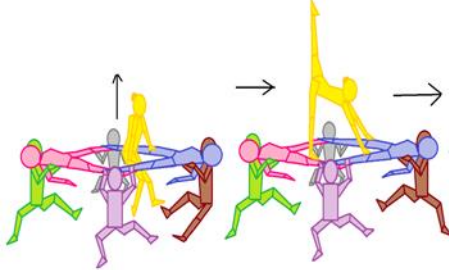
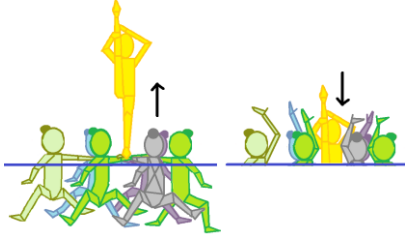
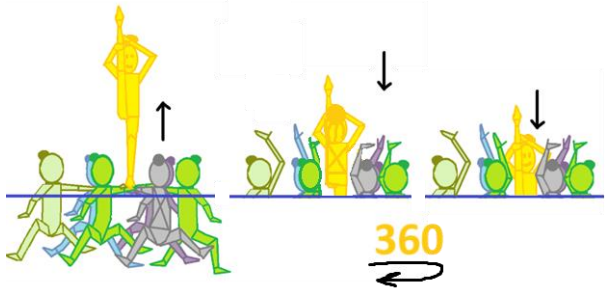

		<p><b>“Roll” on the construction and/or “rolling”</b> (connected arching- action of platform construction, when featured-swimmer submerges after 90° and support-swimmer follows showing 180° arch-action above surface) entrance in the water</p> <p><b>Can't be declared twice! It is a beginning and/or ending action</b></p>		<p><b>0.20</b></p>
		<p><b>Lifting in a “Box” and lowering back</b></p>		<p><b>0.20</b></p>
Can't be in same acro	<p><b>Spider</b></p>	<p><b>“Spider” action</b></p> <p>Platform, 2 support formation: featured-swimmer twists in the shoulder and thigh joints and appears from underwater on a construction. This action has flexibility risk factor</p>		<p><b>0.075</b></p>
	<p><b>Climb</b></p>	<p><b>Climb</b> onto the platform from under the water (<b>inside the construction</b>)</p>		<p><b>0.05</b></p>
Can't be in same acro	<p><b>Fall</b></p>	<p><b>Fast fall down inside construction</b></p>		<p><b>0.05</b></p>
	<p><b>FTurn</b></p>	<p><b>Fast fall down inside platform construction with 360°+ turn</b> (must be completed by waist respecting the allowances)</p>		<p><b>0.10</b></p>



<p><b>Swim</b></p>	<p><b>Change of Featured-swimmer</b></p> <p>Coach declares position/s and type of connection of a second featured-swimmer</p>		<p><b>0.20</b></p>
<p><b>Arch</b></p>	<p>From underwater, non-stop transition to a Position 1 Queen (demonstrating a 2<sup>nd</sup> position head-down is optional) and stand-up back on 2 feet (may have help from base-swimmer)</p>		<p><b>0.30</b></p>

**29.7.1.6 Group C**

**Component C – Construction**

- When in the Code we see **“Thr”** – that means a “pusher” formation. Any way of pushing or jumping will be written as Throw (ie. Thr). Some examples of Thr in Group C:

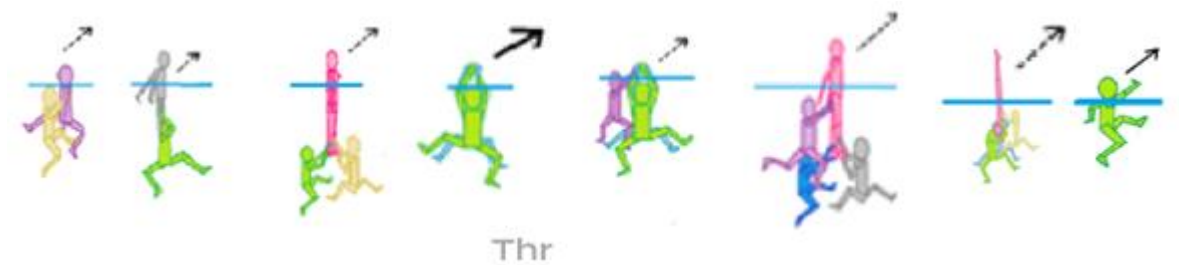

- Transit** – is a term used when the featured-swimmer is held/supported by the support-swimmer of second formation from the beginning. The support-swimmer “pulls/helps” the featured-swimmer to its own formation. The featured-swimmer may continue their movement and enter the water or remain on the support-swimmer (bonus).
- Jump (in group C)** – is a term used when the featured-swimmer is **not** connected at the beginning with the second formation. There's a *clear jump* from one formation to another (that is a bonus) and a connection after a flying phase. The featured-swimmer may remain on the support-swimmer (bonus) or continue their movement until entering the water. Declaration is **“Jump”** bonus (onto support) OR if there's a continuing movement into the water (through support) they should declare **“Jump >”**.

- Example:* Thr>StH (Transit or jump onto Stack head-down from any kind of throw).

The coach wants to perform the first phase as a clear Jump. So, the coach adds a bonus **“Jump”** to the acro code. They have to make sure that the featured-swimmer remains on 2nd formation (stack head-down) until submergence. If the coach wants in an acrobatic movement to have an action where the featured-swimmer jumps on the 2nd formation and continues moving into the water (for example it is a handspring), they declare **“Jump>”**. In the case when the coach is not sure if the swimmer will be able to execute the requirements of the bonus Jump or Jump>, the coach can still declare this as Thr>StH but leave the bonus off and be safe of not receiving a Base Mark while still performing the acrobatic as planned.

- Note:** when Jump is declared in group C, make sure that the featured-swimmer does not perform it as *“climbing on”*. Technical Controllers must see a jump onto the 2nd formation (shoulders and upper chest of the “jumping” featured-swimmer must pass the horizontal invisible line that is on a same level with the feet of the 2nd formation’s featured-swimmer and only then connect).



- **Note:** if the 2nd formation is head-up: the crotch of the "jumping" featured-swimmer must pass the horizontal invisible line that is on a same level with the top of the head of the 2nd formation's featured-swimmer and only then connect.
- Example of climbing on (Transit) -> Not a Jump:



- Example of desirable execution:

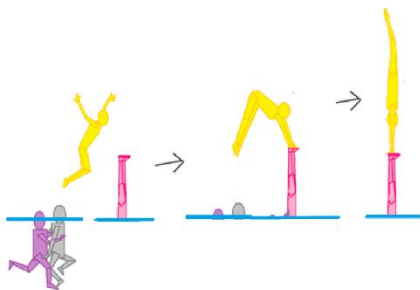



- If the bonus **Jump** is declared: After landing on the second formation, if the featured-swimmer falls from it (any time: immediately after landing, after some time or before submerging) or never lands on 2<sup>nd</sup> formation (ie. the connection is lost) = Base Mark
- Connections can be "broken" before submergence if not clearly stated that it should remain connected throughout.
- Inside construction code: > means a transit or a jump from one formation to another or from one formation to the water
- **Piked arrow** ^ inside construction code: means jump from one formation and fly above another without touching, and entering the water beyond.
- If there is no > at the end of the construction code, it means that you can remain on the 2nd formation or pass through the 2nd formation before entering water.
- If there is a > at the end of the construction code, we **MUST** see a pass through of the 2nd formation and continue to enter the water.
- In group C, constructions have a special number +0.275, which is an "increaser" assigned to have a balance between Main Groups.
- To be considered as part of construction (the part of the whole acrobatic movement, not as hybrid or pair acro), one of the formations (Main Formation) In Group C must:
  - When Stack or Stack head-down is declared:
    - It must contain at least: 1 base-swimmer+ 1 support-swimmer+ 1 featured-swimmer.
  - When a Lift is declared:
    - It must consist of at least: 1 base-swimmer+ 1 featured-swimmer.



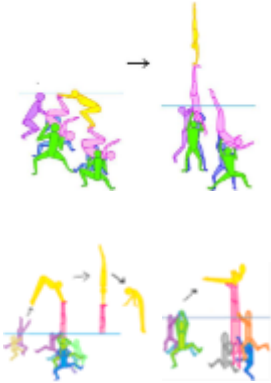
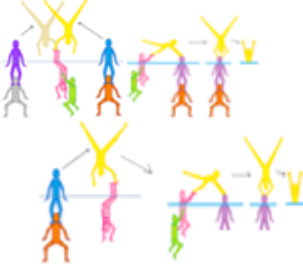

- When platform/s or float/s (1 or more support-swimmers):
  - It must have at least 1 base-swimmer under support/s
- For flying over constructions (fly above 2<sup>nd</sup> formation or fly above lift on heads is declared), it MUST be performed (the flying phase) when the featured-swimmer of the second formation (above which the featured-swimmer flies) is at the “positions allowance safe zone” or higher (Waist or Knees).

Group C Construction									
#	Picture	Name and number of levels	Difficulty of coordinating actions and number formations	Support: Body position and level of sustainability	Air-borne weight	Tempo of acceleration and push (lift/throw)	Area of support	Bonus	Total
1		Transit or Jump on Stack from any kind of throw  <b>Thr&gt;St</b>	Med	High level of sustainability+ low vestibular load	1+0.5	Fast/med (0.3/0.2)	Small-med (possible grips: E, PP...)	+0.275 increaser	<b>1.125</b>
			0.2	0	0.15	0.25	0.25	+0.275 increaser	



2		Transit or jump onto Stack head-down from any kind of throw	Med	Low level of sustainabil- ity+ high ves- tibular load and 1 support is head-up	1+0.5	Slo/med (0.2/0.1)	Small-med	+0.275 increa- ser	<b>1.20</b>
		<b>Thr&gt;StH</b>	0.2	0.2	0.15	0.15	0.225		
3		Through: 2 pair (One of them can be head-down) +featured-swimmer	Basic	-	1	Med	Med	+0.275 increa- ser	<b>0.675</b>
		Can be transit	0	0	0.1	0.2	0.1		
4		To 2-3 or more floats (swimmers floating on a sur- face connected to each other) from any kind of throw	Med	High level of sustainabil- ity+ low ves- tibular load (laying) two	1+1+1	Climb/no	big	+0.275 increa- ser	<b>1.125</b>
		Can be as transit  May remain on plat- forms	0.2	0.2	0.3	0.05	0.1		





5		<p>Any kind of throw on a float (1 support-swimmer is floating on a surface)</p> <p>Featured-swimmer may continue to move and enter the water.</p> <p>Can be as transit.</p> <p>Can continue movement.</p> <p><b>Thr&gt;F</b></p>	Easy	High level of sustainability+ low vestibular load (laying)	1+1	Fast/no	Med-big	+0.275 increaser	<b>0.875</b>
			0.1	0	0.2	0.15	0.15		
6	 <p>Lift can be on 1,2,3 or 4 heads +combinations ie. 2 heads and 2 shoulders; 1 head and 1 shoulder base</p>	<p>Fly above Lift on heads from any kind of throw</p> <p><b>Thr^Lh</b></p>	Hard	-	1+1	Fast/slow-med (0.3/0.1)	Big	+0.3 fly above formation on heads	<b>1.575</b>
			0.3	0	0.2	0.2	0.1	+0.275 increaser	
7		<p>Fly above Second formation (lift, pair acro, stack-head-down, stack) from any kind of throw</p> <p><b>Thr^2F</b></p>	Med	May be	1+1	Fast/slow-med (0.3/0.1)	Big	+0.2 fly above formation	<b>1.175</b>
			0.2	0	0.2	0.2	0.1	+0.275 increaser	

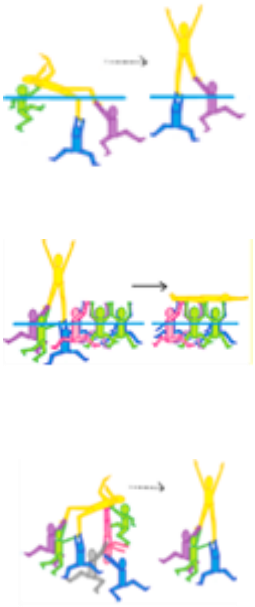
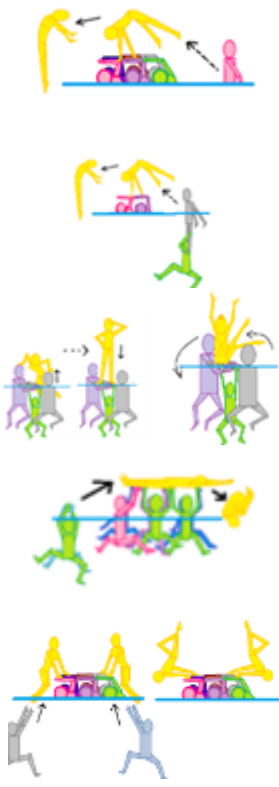



8		<p>Simple lift + «spotter/s»</p> <p>2 formations of base-swimmers gather under 1 f.swimmer and</p> <p><b>Option 1:</b> f.swimmer is laying on a surface, one of the base-swimmers' formation push part of the f.swimmers body and they stand-up on a 2nd formation. May remain on this 2nd formation until submergence or continue moving/disconnect and enter the water</p> <p><b>Option 2:</b> f.swimmer stands-up as regular lift on the 1st formation with</p> <p>2nd formation waiting. F.swimmer falls on the 2nd formations' base-swimmer who catch them before submergence. F.swimmer may continue moving/disconnect and enter the water.</p>	Low	-	1	Med/no (0.2/0)	Medium	+0.275 increaser	<b>0.775</b>
		<p><b>L+spot &gt;</b></p>	0.1	0	0.1	0.1	0.2		
9		<p>Through formation from hands from any kind of throw/push</p> <p>Can be as transit.</p> <p>Arms might be on the surface</p> <p><b>Thr &gt;hand&gt;</b></p>	Low	no	1	Fast/no	Medium	+0.275 increaser	<b>0.875</b>
		0.1	0	0.1	0.15	0.25			



10		2 Jumps from throws (2 featured-swimmers in connection with each other)	Hard	High level of sustainability+ low vestibular load	1+1	med	Medium	+0.1 for connect between 2 featuredswimmers	<b>1.275</b>
		<b>Thr+Thr</b>	0.3	0	0.2	0.2	0.2	+0.275 increase	
11		Snake-type  (1 featured-swimmer after showing balance stack becomes airborne in connection/  together with support-swimmer, after showing arc-dive both of them enter water one-by-one while still keeping the connection)	Med	Optional	1+1	Med	Med	+0.275 increase	<b>1.175</b>
		<b>Sn</b>	0.2	0.1	0.2	0.2	0.2		
12	 <p>Can be on heads.</p> <p>Position of the balancing featured-swimmer can be different from Bridge.</p>	On lift from any kind of throw with connection!  (means there <u>must</u> be a connection between f.swimmer and lift after take-off phase)	Hard	-	1+1	Fast/slow -med (0.3/0.1)	Big	+0.275 increase	<b>1.075</b>
		Can be transit  f-swimmer may remain on the 2nd/main formation  <b>Thr&gt;L</b>	0.3	0	0.2	0.2	0.1		



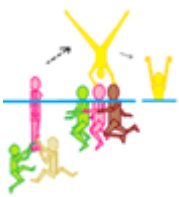
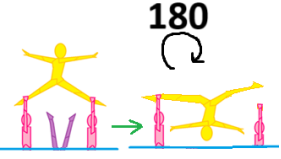

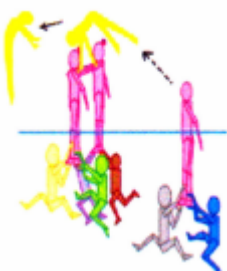
13		Through 1, 2 or 3 heads from any kind of throw	Med	no	1	(0.3/0) Med/no	Medium	+0.2 (bonus for head-connection)	<b>1.075</b>
		Can be as transit  <b>Thr&gt;head&gt;</b>	0.2	0	0.1	0.1	0.2	+0.275 increaser	
14		2 mini-Stack (head-up) +spotter (head-up or head-down).	Med	no	1+0.5 +0.5	Med	Med	+0.275 increaser	<b>1.075</b>
		Starts as 2 support Stack, after reaching max height f.swimmer is pushed by one of the supports and disconnects to perform actions in the air while keeping connection with 2nd support-swimmer)  <b>2Sup+</b>	0.2	0	0.2	0.2	0.2		
15		Throw onto Small-Square formation	Hard	NO	1	Fast/slow -med (0.3/0.1)	Extra-hard Small	+0.275 increaser	<b>1.375</b>
		<b>Thr&gt;Sq</b>	0.3	0	0.1	0.2	0.5		
16		Transit or jump on 2-Stacks from any kind of throw	Med	High level of sustainability+ low vestibular load	1+1+0.5	Fast/med (0.3/0.2)	Small-med	+0.275 increaser	<b>1.225</b>
		<b>Thr&gt;St2</b>	0.2	0	0.25	0.25	0.25		



**Note:** In the acro below, the coach declares *Thr>St* (Transit or Jump on Stack from any kind of throw). The additional formation between the 2 formations (pushing and main ones) that doesn't take part in acro and does not influence the DD is considered in AI and cannot be declared as bonus!



### Component D – Direction

The same as in group A, plus on additional special direction for group C:

Direction	Code	Diagram	Value
<b>Blind back jump</b> <b>No connection</b> between featured-swimmer and main construction before jump	<b>BIn</b>		<b>0.2</b>

### Component P – Position

Use the Position Charts from GROUP A and GROUP B

- If in an acrobatic movement, the featured-swimmer after getting on a “main” formation remains on it - use table from group B. Considering as Position 1 – first position in the order after take-off when featured-swimmer gets on support-swimmer/s.
- If a coach uses a Group A position when they should have used a Group B position or vice-versa = Base Mark
- If in an acrobatic movement the featured-swimmer after getting on a “main” formation continues their movement and becomes airborne and later enters the water, use a position from group A. Considering as Position 1 – first position in the order after take-off that is happening in the air (for example: if it's a handspring or somersault use positions from group A)
- **Notes for 2 Featured-swimmers:** In a Combined acrobatic movement (which consists of 2 formations) where 1 featured-swimmer executes and maintains a position (ie lift or stack, stack head-down) it should be calculated in as Position 1 declaration. If the second featured-swimmer jumps above the first formation demonstrating a position, it should be declared as Position 2. All other positions (no matter which featured-swimmer does it) will be considered as a 3rd Position bonus.



- **Note for Construction of the “snake” type:** The rule for 2 featured-swimmers applies. If featured-swimmers perform the same position it is declared once as Position 1. If it is 2 different positions, the position of the first featured-swimmer that appears above the water surface will be declared as Position 1. The second featured-swimmer that originally is the support-swimmer that disconnects and appears after the first featured-swimmer – their position will be declared as Position 2. Group A positions must be used for this type of acrobatic movement.

**Component S – Area of Support**

N/A for GROUP C (Value already inside construction)

**Component R – Rotation of the Construction Base**

- Must happen with support and featured-swimmer together (for example: after the featured-swimmers lands on a second formation), unless otherwise specified.
- In group C, in a Stack or Stack-head-down formation we need to see the support-swimmer turning with the featured-swimmer on top (Ariana turn may happen and will be acceptable if TC will recognise that support-swimmer is also turning)

Values for the rotation of the construction base in group C:				
Type	Degree of rotation			
	90°	180°	360°	540°
Value* for <b>Stack</b> <b>If the featured-swimmer AND the Support-Swimmer are NOT in head-down position</b> (constructions #1, possible #12)	-	<b>Cr0.5</b>	<b>Cr1</b>	<b>Cr1.5</b>
<i>*Support-swimmer with featured-swimmer on top rotates around self after landing or reaching max height stop-point</i>	-	0.2	0.3	0.4
Value* for <b>Stack</b> <b>If the featured-swimmer AND/OR the Support-Swimmer is in head-down position</b> (constructions #2, possible #12)	-	<b>Cr0.5!</b>	<b>Cr1!</b>	<b>Cr1.5!</b>
<i>*Support-swimmer with featured-swimmer on top rotates around self after landing or reaching max height stop-point</i>	-	0.3	0.4	0.5
Value for <b>Lift on heads</b> while <b>featured-swimmer flies above it</b>	-	<b>Cr0.5L</b>	-	-
Note: the same rule as in group B (where in Lift construction)- the whole construction rotates. This applies to group C too, where in Lift-formation base-swimmers move to another spot in the water with featured-swimmer on top. (NOT ARIANA turn!!!!!!) (constructions #6)	-	0.4	-	-
Value for the <b>platform</b> (formation) <b>after featured-swimmer lands on it</b> (constructions #4, 5)	-	<b>CPO.5</b>	-	-
	-	0.4	-	-
Special rotation for the second formation in <b>Thr^2F construction</b> <b>(TC look at the rotation of the featured-swimmer)</b> (constructions #7)	-	<b>2FO.5</b>	<b>2F1</b>	-
	-	0.25	0.35	-

**Component T – Plane and Degree of Rotations**

Values for featured-swimmer's rotations in the air			
#	Description	code	value
1	1/2 twist (group C)	<b>Ct0.5</b>	0.025
2	1 twist (group C)	<b>Ct1</b>	0.05
3	1.5 twist (group C)	<b>Ct1.5</b>	0.10
4	2 twists (group C)	<b>Ct2</b>	0.20
5	2.5 twist (group C)	<b>Ct2.5</b>	0.25
6	3 twists (group C)	<b>Ct3</b>	0.35
7	Dive/180 somersault (group C)	<b>Cd</b>	0.025
8	1/2 twist + dive (group C)	<b>Cdt0.5</b>	0.05
9	1 twist + dive (group C)	<b>Cdt1</b>	0.10
10	1.5 twist + dive (group C)	<b>Cdt1.5</b>	0.15
11	1 somersault (group C)	<b>Cs1</b>	0.20
12	1 straight somersault (group C)	<b>Css1</b>	0.30
13	1.5 somersault (group C)	<b>Cs1.5</b>	0.40
14	1.5 somersault + open (group C)	<b>Cs1.5o</b>	0.60
15	1 frontal somersault (group C)	<b>Cf1</b>	0.30
16	1.5 frontal somersault (group C)	<b>Cf1.5</b>	0.50
17	2 frontal somersaults (group C)	<b>Cf2</b>	0.60
18	Cartwheel (group C)	<b>Cc</b>	0.05
19	Cartwheel + 1/2 twist (group C)	<b>Cct0.5</b>	0.10
20	Cartwheel + 1 twist (group C)	<b>Cct1</b>	0.15
21	Handspring (group C)	<b>Ch</b>	0.05
22	Handspring + 1/2 twist (group C)	<b>Ch0.5</b>	0.10
23	Handspring + 1 twist (group C)	<b>Ch1</b>	0.15
24	1/2 somersault + 1/2 twist (group C)	<b>Cs0.5t0.5</b>	0.125
25	1 somersault + 1/2 twist (group C)	<b>Cs1t0.5</b>	0.35
26	1 somersault + 1 twist (group C)	<b>Cs1t1</b>	0.40
27	1 somersault + 1.5 twist (group C)	<b>Cs1t1.5</b>	0.45
28	1 somersault + 2 twists (group C)	<b>Cs1t2</b>	0.50
29	1 straight somersault + 1/2 twist (group C)	<b>Css1t0.5</b>	0.45
30	1 straight somersault + 1 twist (group C)	<b>Css1t1</b>	0.50
31	1 straight somersault + 1.5 twist (group C)	<b>Css1t1.5</b>	0.60
32	1 straight somersault + 2 twists (group C)	<b>Css1t2</b>	0.65
33	1 straight somersault + 2.5 twists (group C)	<b>Css1t2.5</b>	0.70
34	1 somersault + 1 twist + open (group C)	<b>Cs1t1o</b>	0.55
35	1 somersault + 1.5 twist + open (group C)	<b>Cs1t1.5o</b>	0.65
36	1 somersault + 2 twists + open (group C)	<b>Cs1t2o</b>	0.75
37	Handspring + 1 somersault (group C)	<b>Chs1</b>	0.25

- For Thr+Thr Construction coach declares only one type of rotation in the air of the "second" featured swimmer (not the one that appears from underwater first and leads the jump). TC looks at the one who is "finishing the jump". For example: first featured-swimmer performs a dive, second featured-swimmer follows them and performs one somersault before entering the water. Coach declares only 1 somersault (Cs1).



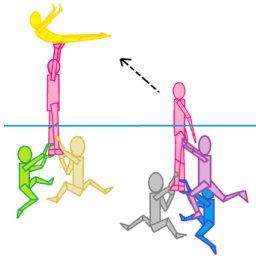
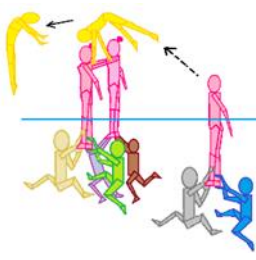
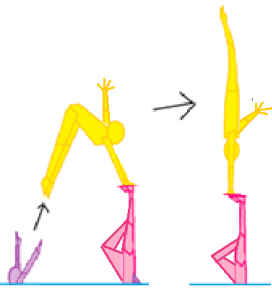
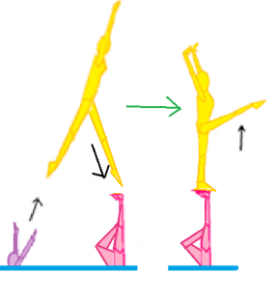

- In group C, Thr >StH, if featured-swimmer jump head up and lands on the second formation performing handstand position (such as Bamboo etc.) -it is not considered as Dive

**Component B – Bonus**

List of additions, bonuses, and risk-elements in group C			
	Code	For GROUP C	Value
	<b>Dbl</b>	<p><b>Synchronized actions for double</b> acrobatic movements</p> <p>(from beginning to the end. May have connection between 2 featured-swimmers).</p>	 <p><b>0.20</b></p>
Can't be in same acro	<b>Jump</b>	<p><b>Jump on Stack</b> and <b>remain on it until submergence</b></p>	 <p><b>0.20</b></p>
	<b>Jump&gt;</b>	<p><b>Jump and pass through the 2<sup>nd</sup> formation (no connection between f.swimmer and support/s of 2<sup>nd</sup> formation in the beginning. Connection happens after flying phase (minimal requirement))</b></p>	 <p><b>0.10</b></p>
	<b>On1Foot</b>	<p><b>Jump from any kind of Throw, onto 1 foot of support-swimmer (2<sup>nd</sup> formation) and balance on 1 palm while performing actions.</b></p>	 <p><b>0.40</b></p>
	<b>1F&gt;1F</b>	<p><b>Jump of featured swimming landing with 1 foot onto 1 foot of the support-swimmer (2<sup>nd</sup> formation) and balancing on the 1 foot while performing actions.</b></p> <p>Safety note: for Senior category only, 12U, Youth or Juniors who declare will receive a BM.</p>	 <p><b>1.50</b></p>

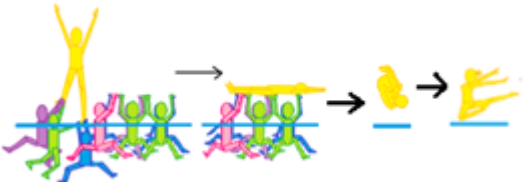
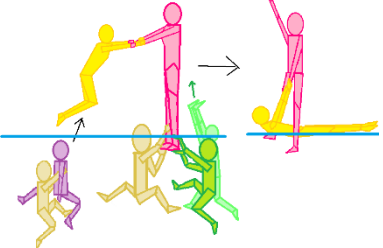
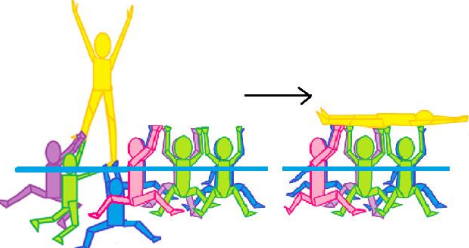
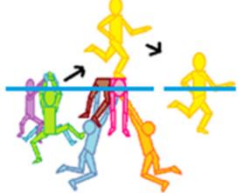

	<b>Pos3</b>	<p><b>Third position.</b></p> <p>Example: at the end of an acrobatic movement closing legs from split to vertical or tucking (any additional position 3rd, 4th, 5<sup>th</sup> etc.). This bonus should be declared only once no matter how many positions f.swimmer will perform after the first 2 declared ones.</p>		<b>0.05</b>
	<b>Slip</b>	<p>Featured-swimmer <b>“Slips through”</b> after <b>jump</b> between support’s legs (support is head-up) or hands</p> <p><b>(can have connection between f.swimmer and support/s of 2<sup>nd</sup> formation)</b></p>		<b>0.10</b>
	<b>Bey</b>	<p>“Beyonce fall” (<b>from lift - blind fall backwards on the other formation made from hands</b>)</p>		<b>0.10</b>
Can't be in same acro	<b>Run</b>	<p><b>Running on the 2+ backs</b> (torso of featured-swimmer=vertical)</p> <p>Note: featured-swimmer must step on each declared back (in construction)</p>		<b>0.20</b>
	<b>BRun</b>	<p><b>“Blind run” on the backs</b></p> <p>Featured-swimmer jumps backwards, or jumps turns and then runs backwards, stepping on each of declared backs (in construction)</p>		<b>0.40</b>



	<p><b>Cx</b></p>	<p><b>Connection between 2 featured-swimmers</b> (may be broken in the end of acrobatic movement before entering water)</p>		<p><b>0.20</b></p>
	<p><b>Twirl</b></p>	<p><b>Twirl</b> of a featured-swimmer</p> <p>Rotation of the featured-swimmer around self to the left or to the right on longitudinal axis (that is done not in the air like twist or somersault)</p>		<p><b>0.05</b></p>
	<p><b>C-Roll</b></p>	<p><b>“Rolling” on top of the construction</b></p> <p>*Can be declared twice during 1 acro</p> <p>(Rolling- the featured-swimmer, climbs on the support-swimmer, crouches down, places their hands shoulder width apart and hands facing forward. Featured-swimmer tucks their chin to their chest and places the back of their head onto support-swimmer. They then push off the spotter with their legs and rotate over their head onto their back)</p>		<p><b>0.10</b></p>
	<p><b>Turn</b></p>	<p><b>Lift up from split (head-up) + featured-swimmer disconnects with one of the supports, makes a rotation 180 in sagittal plane</b> (still in connection with second support).</p>		<p><b>0.25</b></p>



## 29.7.2 Pair Acrobatics Catalogue

### Pair Acrobatics (for Duet / Mixed Duet only)

#### General Principles

- A pair acrobatic movement is considered as a lift or a **throw** if the “bottom” (base/underwater) swimmer is *underwater* and lifts/throws the featured-swimmer (upper swimmer/ flyer/performer) up in the air (away from surface). The base-swimmer can lift/throw the featured-swimmer by holding/pushing their legs or shoulders.
- A pair acrobatic movement is considered as a **jump** if the “bottom” (base) swimmer is underwater and the featured-swimmer jumps in the air from the base-swimmer.
- Rotations around oneself (turn, twist) can be performed in any direction. The direction of the rotation does not influence the DD of the pair acrobatic.
- The way of connecting between the base-swimmer and the featured-swimmer is *optional* and does not influence the DD of the pair acrobatic.
- Pair acrobatic DD values should not be compared to team acrobatic values. They are directly related to the duet/mixed duet events.
- The **base mark** for all types of pair acrobatics is **0.10**.
- When **travelling** is stated in the code and description it means *visible travel* from one spot to another of the base (pushing/support/underwater) swimmer with featured-swimmer supported on top. It must be obvious “visible” moving across the water’s surface!
- When **“crashing”** is *not* mentioned in the code and the description but it happens – it is a Base Mark.
- When **“airborne”** is stated in the description of the pair acrobatic movement, it means that the featured-swimmer must *be disconnected from the base-swimmer and be completely out of water (airborne)* from toes to top of the head at the same time.



- If there is a discrepancy between the images and the written tables:  
The “written description” always prevails.  
Images are there to show some examples.  
Other variations might be possible as long as they respect the “written description”.





- For the clear verification of a pair acrobatic movement by the TCs:

It is recommended to hold a **lift** movement (“L or L!”) for 1-2 seconds and to lift the featured-swimmer by the arms.

If it's a **Throw (“W”)** or a **Jump (“J”)**, a disconnect should be clearly seen. The featured-swimmer must be completely in the AIR (top of the head and toes must be above the surface at the same time). It is recommended to push the featured-swimmer by the feet.

- If you can't achieve a clear disconnection with the featured-swimmer completely airborne, you must declare a lift instead (and not a Throw “W” or a Jump “J”).

A clear difference between dynamic (Throws /Jumps) and balance (Lifts) pair acrobatics should be seen.

- For example: if it's a Lift legs-up with 360° rotation (“L!r1”) the base-swimmer should hold the featured-swimmer for 1-2 seconds and then the featured-swimmer rotates 360°. The base-swimmer can help the featured-swimmer to not descend very fast with their support OR disconnect during the descent.
  - In contrast: if it's a Throw legs-up with 180° rotation (“W!r0,5”): the base-swimmer needs to accelerate and push up the featured-swimmer in the air and disconnect. We must see the featured-swimmer completely out of the water (top of the head to toes) and then rotate 180° before the knees while submerging.
- As per the rules, in duets or mixed duets which have 2 pair acrobatic elements or more, a pair acrobatic code *must not be repeated*.

Example 1: A duet could do L!fr1 and L!fr0.5

Example 2: A duet could do Jd, W!d and L!f

Example 3: A duet could do Jfs1B and Js1B+f

Example 4: A duet COULD NOT do Jfs1B and Jfs1B

Example 5: A duet COULD NOT do W!fr1 and W!fr1



## Allowances

### For Somersaults:

- **90° less** than declared = Base Mark

If you declare a somersault 360° but the featured-swimmer rotates 260°, this would be a Base Mark, but if the featured-swimmer rotates 300° you are ok.

- Notes for declared 360° somersaults and more:

It must be visible fully above the water. For the water-entrance, it is allowed that up to half of the body of the featured-swimmer is submerged.

That means: if you declare a somersault back 360° in flexibility position and during the rotation in the air the head of featured-swimmer slides into the water but rotates fast enough to complete the somersault before entering water inside allowance – it's execution (not a Base Mark). But if after making half-somersault, half of the body of the featured-swimmer is submerged (or more) and then he/she just lifts up the head with top of shoulders- it's a Base mark

- The featured-swimmer can over-rotate (you can do more than you declared)

For example: if you declare a somersault 360° but the featured-swimmer does 400° (or even 540°), this is ok.

Another example: If the featured-swimmer performs a jump head-up with a somersault 270°, it's not a complete 360° and cannot declare a "Js1B" (90° less = Base Mark). You can instead declare a Jump-Dive "Jd" and stay inside "the rule of allowance" because you can over-rotate as long as you "pass" the required number of rotation(s).

### For Twists:

- For **Head-Down Lifts or Throws:**

We calculate the number of rotations until above the **knee(s) (knee caps must be visible)** of the featured-swimmer. The featured-swimmer must not be below the knee caps!

- For **Lifts and Jumps that are head-up:**

We calculate the number of rotations until the **waist level** of the featured- swimmer.

- For **360° declared twists** and more:

**180° less** than declared = Base Mark

- Meaning if you declare 360° but the featured-swimmer rotates 170° to waist (if head-up) or to knee level (if head-down), this would be Base Mark. But if they rotate 200°, it is ok.

- For **180° declared twists:**

There is **no allowance** – performing less than a 180° is a Base Mark. It must be done precisely (or more).

- The featured-swimmer can over-rotate. It is allowed to do more before height allowance (waist/knee), but not less!

**Lift head up clarification**

Acrobatic movements like these are considered Lift head-up (L):

In this image (below on left), the featured-swimmer goes head-up, lifts their legs up and then crashes on the surface. Another example: in the image (below on right), the featured-swimmer is lifted straight up and then submerges.



However, these 2 types of movements pictured below are considered as Pair Assist (and therefore are Transitions):

**Flexibility Positions:**

- Flexibility Positions allowed are:
  - Splits and Over-splits (or variation where back leg is bent so toes touch the water. It is possible to bend forward the leg a little bit, but there must be a clear flexibility demonstrated (180° between knees is desired))
  - The following positions (as defined in Group A/B of the acrobatics catalogue):
    - Vertical Split / Glass / Eye positions (refer to Group B in the Team Acrobatics Catalogue)
    - Knight like in figures (where thigh is 90° back and leg is bent so toes touch the water), or any variation of the “Willow” position from Group B of the Team Acrobatics Catalogue
    - Ring (arch with toes touching or close to touching the head)

**Pair Acrobatic Table:**

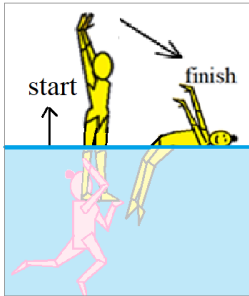
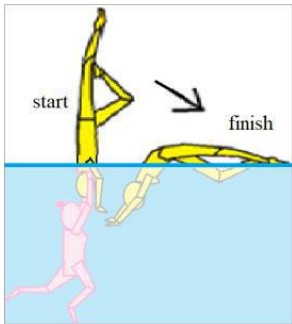
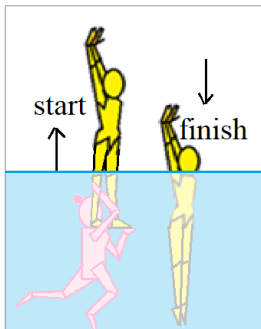
#	Name and code	Diagram	Description	DD of the Pair Acro	Total DD (with Base Mark)
1	Lift head-up with crashing  L»		<p>One swimmer remains under the water and lifts another swimmer who performs actions above the water at maximum height. When the bottom swimmer pushes and releases support the upper swimmer "crashes" (falls) on the surface.</p> <p>Crashing - means that after the main phase of the lift the upper (visible) swimmer does not submerge, but instead falls on the water's surface.</p>	0.10	0.20
2	Lift legs-up with crashing  L!»		<p>One swimmer remains under the water and lifts another swimmer (position head-down) who performs actions above the water at maximum height. When the bottom swimmer pushes and releases support the upper swimmer "crashes" (falls) on the water's surface.</p>	0.20	0.30
3	Lift head-up  L		<p>One swimmer remains under the water and lifts another swimmer who performs actions above the water at maximum height. When the bottom swimmer releases support the upper swimmer submerges under the surface of the water.</p>	0.40	0.50



<p><b>4</b></p>	<p>Lift head-up with flexibility and crashing</p> <p><b>Lf»</b></p>		<p>One swimmer remains under the water and lifts another swimmer, who demonstrates flexibility position/s (split variations, ring, etc.) above the water at maximum height. When the bottom swimmer releases support the upper swimmer submerges under the water.</p>	<p><b>0.40</b></p>	<p><b>0.50</b></p>
<p><b>5</b></p>	<p>Lift legs-up with flexibility and crashing</p> <p><b>Llf»</b></p>		<p>One swimmer remains under the water and lifts another swimmer (position is head-down), who demonstrates flexibility position/s (split variations etc.) above the water at maximum height. When the bottom swimmer pushes and releases support the upper swimmer "crashes" (falls) on the water's surface.</p>	<p><b>0.40</b></p>	<p><b>0.50</b></p>
<p><b>6</b></p>	<p>Lift legs-up with crashing and rotation 180°</p> <p><b>L!r0.5»</b></p>		<p>One swimmer remains under the water and lifts another swimmer (position is head-down), above the water at maximum height. When the bottom swimmer pushes and releases support the upper swimmer simultaneously "crashes" (falls) on the water's surface while rotating 180 around themselves.</p> <p>Note: the rotation may also occur during the "maximum height" phase or while ascending.</p>	<p><b>0.40</b></p>	<p><b>0.50</b></p>
<p><b>7</b></p>	<p>Lift legs-up</p> <p><b>L!</b></p>		<p>One swimmer remains under the water and lifts another swimmer (position is head-down) who performs some actions above the water at maximum height. When the bottom swimmer pushes and releases support the upper swimmer submerges under the water.</p>	<p><b>0.60</b></p>	<p><b>0.70</b></p>



<p><b>8</b></p>	<p>Lift legs-up with crashing and rotation 360°</p> <p><b>L!r1»</b></p>		<p>One swimmer remains under the water and lifts another swimmer (position is head-down) above the water at maximum height. When the bottom swimmer pushes and releases support the upper swimmer simultaneously "crashes" (falls) on the water's surface while rotating 360° around themselves.</p> <p>Note: the rotation may also occur during the "maximum height" phase or while ascending.</p>	<p><b>0.60</b></p>	<p><b>0.70</b></p>
<p><b>9</b></p>	<p>Lift legs-up with crashing, flexibility and rotation 180° (turn)</p> <p><b>L!fr0.5»</b></p>		<p>One swimmer remains under the water and lifts another swimmer (position is head-down) who demonstrates flexibility position/s (split variations etc.) above the water at maximum height. When the bottom swimmer pushes and releases support the upper swimmer simultaneously "crashes" (falls) on the water's surface while rotating 180° around themselves.</p> <p>Note: the rotation may also occur during the "maximum height" phase or while ascending.</p>	<p><b>0.60</b></p>	<p><b>0.70</b></p>
<p><b>10</b></p>	<p>Lift head-up with 180° rotation</p> <p><b>Lr0.5</b></p>		<p>One swimmer remains under the water and lifts another swimmer who performs actions above the water at maximum height. When the bottom swimmer releases support the upper swimmer simultaneously submerges under the water while rotating 180°.</p> <p>Note: the rotation may occur during the "maximum height" phase or while ascending.</p>	<p><b>0.60</b></p>	<p><b>0.70</b></p>
<p><b>11</b></p>	<p>Sustained lift head-up with travelling</p> <p><b>SL&gt;</b></p>		<p>One swimmer remains under the water and lifts another swimmer <u>sustaining the lift for 3 seconds or more while travelling</u>. The upper swimmer performs some actions above the water at maximum height and when the bottom swimmer pushes and releases support the upper swimmer submerges under the water.</p>	<p><b>0.80</b></p>	<p><b>0.90</b></p>



<p><b>12</b></p>	<p>Lift legs-up with 180° rotation</p> <p><b>Llr0.5</b></p>		<p>One swimmer remains under the water and lifts another swimmer (position is head-down) who performs actions above the water at maximum height. When the bottom swimmer pushes and releases support (or helps to rotate) the upper swimmer submerges with a simultaneous rotation of 180°.</p> <p>Note: the rotation may also occur during the “maximum height” phase or while ascending.</p>	<p><b>0.80</b></p>	<p><b>0.90</b></p>
<p><b>13</b></p>	<p>Lift head-up with flexibility and rotation 180°</p> <p><b>Lfr0.5</b></p>		<p>One swimmer remains under the water and lifts another swimmer who demonstrates flexibility position/s (split variations, ring etc.) above the water at maximum height. When the bottom swimmer releases support (or helps to rotate) the upper swimmer submerges under the water with a simultaneous rotation of 180°.</p> <p>Note: the rotation may also occur during the “maximum height” phase or while ascending.</p>	<p><b>0.80</b></p>	<p><b>0.90</b></p>
<p><b>14</b></p>	<p>Lift legs-up with flexibility</p> <p><b>Llf</b></p>		<p>One swimmer remains under the water and lifts another swimmer (position is head-down) who demonstrates flexibility position/s (split variations etc.) above the water at maximum height. When the bottom swimmer pushes and releases support the upper swimmer submerges under the water.</p>	<p><b>0.80</b></p>	<p><b>0.90</b></p>
<p><b>15</b></p>	<p>Sustained lift legs-up with travelling</p> <p><b>SL!&gt;</b></p>		<p>One swimmer remains under the water and lifts another swimmer (position is head-down) and <u>sustains the lift for 3 seconds or more while travelling</u>. The upper swimmer performs some actions above the water at maximum height and when the bottom swimmer pushes and releases support the upper swimmer submerges under the water.</p>	<p><b>0.80</b></p>	<p><b>0.90</b></p>



<p><b>16</b></p>	<p>Lift head-up with rotation 360°</p> <p><b>Lr1</b></p>		<p>One swimmer remains under the water and lifts another swimmer, who performs actions above the water at maximum height. When the bottom swimmer releases support the upper swimmer simultaneously submerges under the water while rotating 360°.</p> <p>Note: the rotation may also occur during the "maximum height" phase or while ascending.</p>	<p><b>0.80</b></p>	<p><b>0.90</b></p>
<p><b>17</b></p>	<p>Jump head-up</p> <p><b>J</b></p>		<p>From under the water one swimmer pushes and throws (disconnects with) an upper (visible) swimmer who becomes airborne. This upper (visible) swimmer performs some actions in the air before entering the water.</p>	<p><b>0.80</b></p>	<p><b>0.90</b></p>
<p><b>18</b></p>	<p>Throw legs-up with crashing</p> <p><b>W!&gt;</b></p>		<p>From under the water one swimmer pushes and throws (disconnects with) an upper (visible) swimmer who becomes airborne. This upper (visible) swimmer starts their action feet-first and after demonstrating maximum height "crashes" (falls) on the surface.</p>	<p><b>0.80</b></p>	<p><b>0.90</b></p>
<p><b>19</b></p>	<p>Lift legs-up with rotation 360°</p> <p><b>Lr1</b></p>		<p>One swimmer remains under the water and lifts another swimmer (position is head-down), who performs some actions above the water at maximum height. When the bottom swimmer pushes and releases support the upper swimmer simultaneously submerges under the water while rotating 360°.</p> <p>Note: the rotation may also occur during the "maximum height" phase or while ascending.</p>	<p><b>1.00</b></p>	<p><b>1.10</b></p>



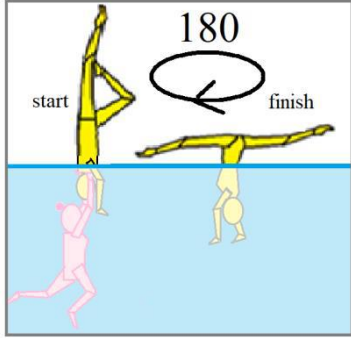
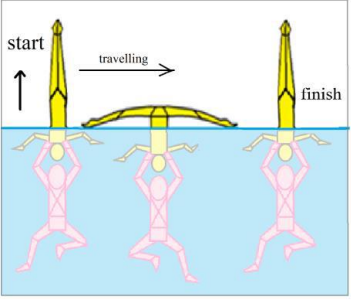
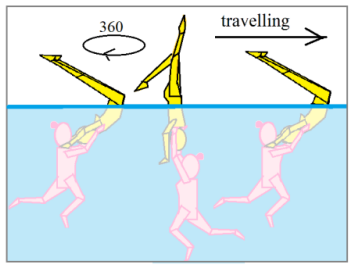
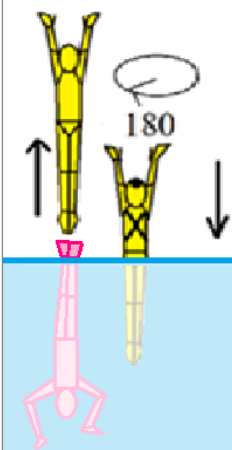

<p><b>20</b></p>	<p>Lift legs-up with flexibility and rotation 180°</p> <p><b>Llfr0.5</b></p>		<p>One swimmer remains under the water and lifts another swimmer (position is head-down), who demonstrates flexibility position/s (split variations etc.) above the water at maximum height. When the bottom swimmer pushes and releases the upper swimmer simultaneously submerges under the water while rotating 180°.</p> <p>Note: the rotation may also occur during the "maximum height" phase or while ascending.</p>	<p><b>1.00</b></p>	<p><b>1.10</b></p>
<p><b>21</b></p>	<p>Sustained lift legs-up with flexibility and travelling</p> <p><b>SLlf&gt;</b></p>		<p>One swimmer remains under the water and lifts another swimmer (position is head-down), <u>sustaining the lift for 3 seconds or more while travelling</u>. The upper swimmer demonstrates flexibility position/s above the water at maximum height and when bottom swimmer pushes and releases, the upper swimmer submerges under the water.</p>	<p><b>1.00</b></p>	<p><b>1.10</b></p>
<p><b>22</b></p>	<p>Sustained lift legs-up with travelling and rotation of 180°-360°</p> <p><b>SLlr0.5&gt;</b> or <b>SLlr1&gt;</b></p>		<p>One swimmer remains under the water and lifts another swimmer (position is head-down), <u>holding for 3 seconds or more while travelling</u>. The upper swimmer performs some actions while rotating 180°-360° above the water at maximum height. When the bottom swimmer pushes and releases support the upper swimmer submerges.</p> <p>Note: the rotation may also occur while ascending.</p>	<p><b>1.00</b></p>	<p><b>1.10</b></p>
<p><b>23</b></p>	<p>Jump head-up with 180° rotation</p> <p><b>Jr0.5</b></p>		<p>From under the water one swimmer pushes and throws (disconnects with) the upper (visible) swimmer who becomes <u>airborne</u>. The upper (visible) swimmer performs some actions in the air with a 180° rotation, before entering the water.</p> <p>Note: rotation may also occur while the upper-swimmer submerges.</p>	<p><b>1.00</b></p>	<p><b>1.10</b></p>



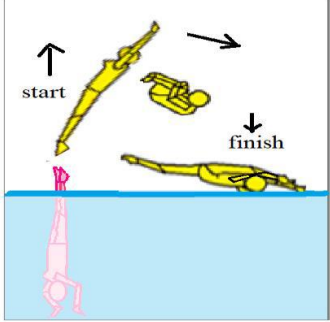
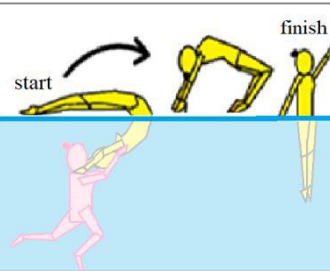
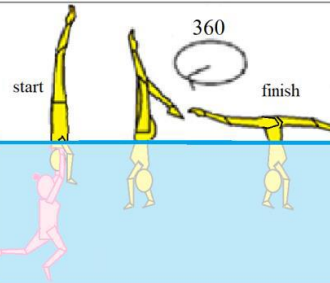
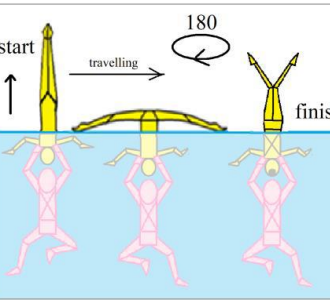

<p>24</p>	<p>Jump head-up with flexibility</p> <p><b>Jf</b></p>		<p>From under the water one swimmer pushes and throws (disconnects with) the upper (visible) swimmer who becomes airborne. The upper (visible) swimmer demonstrates flexibility position/s (such as split etc.) in the air before entering the water or falling/crashing.</p>	<p><b>1.00</b></p>	<p><b>1.10</b></p>
<p>25</p>	<p>Legs-Up Throw-Dive</p> <p><b>Wld</b></p>		<p>From a Pike Position the upper swimmer is pushed/thrown by the bottom swimmer (disconnects/becomes airborne). The upper swimmer's legs are lifted in an arc over the surface of the water to meet the surface of the water again. The upper swimmer enters the water feet-first and lifting their upper body to a vertical position before submerging.</p>	<p><b>1.00</b></p>	<p><b>1.10</b></p>
<p>26</p>	<p>Lift legs-up with flexibility and rotation 360°</p> <p><b>Lifr1</b></p>		<p>One swimmer remains under the water and lifts another swimmer (position is head-down). The upper swimmer demonstrates flexibility position/s above the water at maximum height with 180°-360° rotation. When the bottom swimmer pushes and releases support the upper swimmer submerges under the water.</p> <p>Note: rotation may occur while the upper-swimmer submerges or while ascending.</p>	<p><b>1.20</b></p>	<p><b>1.30</b></p>
<p>27</p>	<p>Sustained lift legs-up with flexibility, travelling and rotation 180°-360°</p> <p><b>SLifr0.5&gt;</b> or <b>SLifr1&gt;</b></p>		<p>One swimmer remains under the water and lifts another swimmer (position is head-down), <u>sustaining the lift for 3 seconds or more while travelling</u>. The upper swimmer demonstrates flexibility position/s above the water at maximum height with 180°-360° rotation. When the bottom swimmer pushes and releases support the upper swimmer submerges under the water.</p> <p>Note: rotation may occur while the upper-swimmer submerges or while ascending.</p>	<p><b>1.20</b></p>	<p><b>1.30</b></p>



<p><b>28</b></p>	<p>Throw legs-up with 180° rotation</p> <p><b>W!r0.5</b></p>		<p>From under the water one swimmer pushes and throws (disconnects with) the upper (visible) swimmer who becomes <u>airborne</u>. The upper (visible) swimmer starts their action feet-first and after demonstrating maximum height submerges with a simultaneous rotation of 180°.</p> <p>Note: rotation may also occur during "pushing"/ ascending phase.</p>	<p><b>1.20</b></p>	<p><b>1.30</b></p>
<p><b>29</b></p>	<p>Throw legs-up with flexibility</p> <p><b>W!f</b></p>		<p>From under the water one swimmer pushes and throws (disconnects with) the upper (visible) swimmer who becomes <u>airborne</u>. The upper (visible) swimmer starts their action feet-first and demonstrates flexibility position/s during maximum height and then submerges.</p>	<p><b>1.20</b></p>	<p><b>1.30</b></p>
<p><b>30</b></p>	<p>Jump-Dive</p> <p><b>Jd</b></p>		<p>From under the water one swimmer pushes and throws (disconnects with) the upper (visible) swimmer who becomes <u>airborne</u>. This upper (visible) swimmer demonstrates an arc over the surface before entering the water in a head-first vertical position.</p>	<p><b>1.20</b></p>	<p><b>1.30</b></p>
<p><b>31</b></p>	<p>Throw legs-up with 180° somersault</p> <p><b>W!s0.5</b></p>		<p>From under the water one swimmer pushes and throws (disconnects with) the upper (visible) swimmer who becomes <u>airborne</u>. This upper (visible) swimmer starts their action feet-first and by lifting their body and tucking, performs 0.5 (half) somersault (180° rotation) in the air before entering the water.</p> <p>Note: the body of the upper (visible) swimmer should be fully out of the water (above the surface) before entering the water.</p>	<p><b>1.40</b></p>	<p><b>1.50</b></p>

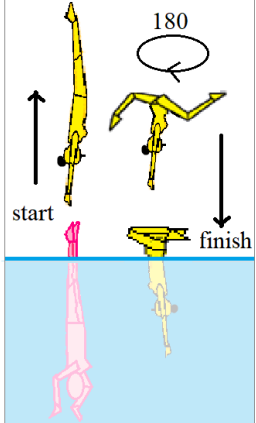

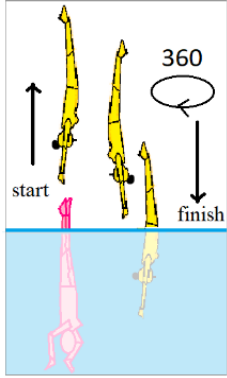
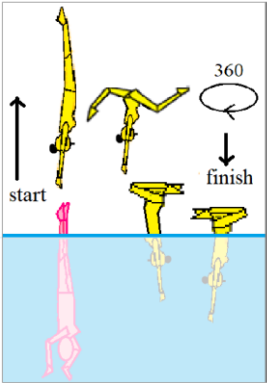



<p><b>32</b></p>	<p>Throw legs-up with flexibility and rotation 180°</p> <p><b>W!fr0.5</b></p>		<p>From under the water one swimmer pushes and throws (disconnects with) an upper (visible) swimmer who becomes <u>airborne</u>. The upper (visible) swimmer starts their action feet-first and demonstrates flexibility position/s during maximum height. The upper (visible) swimmer then submerges while simultaneously rotating 180°.</p>	<p><b>1.40</b></p>	<p><b>1.50</b></p>
<p><b>33</b></p>	<p>Jump-Tuck/ Change position – Dive</p> <p><b>Jpd</b></p>		<p>From under the water one swimmer pushes and throws (disconnects with) an upper (visible) swimmer who becomes <u>airborne</u>. The upper (visible) swimmer performs 180° (half) somersault backwards with 1 change of the position in the air before entering the water headfirst.</p> <p>Note: any “non-flexibility” position is allowed to be demonstrated in the air.</p>	<p><b>1.40</b></p>	<p><b>1.50</b></p>
<p><b>34</b></p>	<p>Throw legs-up with rotation 360°</p> <p><b>W!r1</b></p>		<p>From under the water one swimmer pushes and throws (disconnects with) the upper (visible) swimmer who becomes <u>airborne</u>. The upper (visible) swimmer starts their action feet-first and after demonstrating maximum height submerges with a simultaneous rotation of 360°.</p> <p>Note: rotation may also occur during “pushing”/ascending phase.”</p>	<p><b>1.40</b></p>	<p><b>1.50</b></p>
<p><b>35</b></p>	<p>Throw-legs up with flexibility and rotation 360° or more</p> <p><b>W!fr1</b></p>		<p>From under the water one swimmer pushes and throws (disconnects with) an upper (visible) swimmer who becomes <u>airborne</u>. The upper (visible) swimmer starts their action feet-first and demonstrating flexibility position/s during maximum height. The upper (visible) swimmer then submerges while simultaneously rotating 360° degrees or more.</p>	<p><b>1.60</b></p>	<p><b>1.70</b></p>



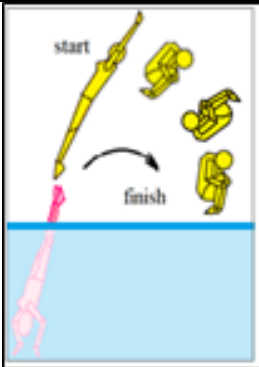

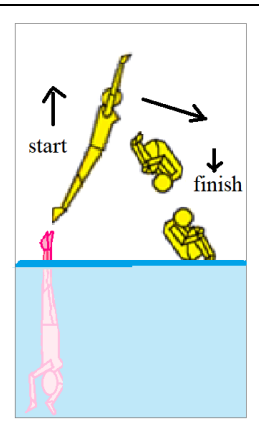
<p><b>36</b></p>	<p>Jump head-up with half twist and 180 somersault</p> <p>Js0.5t0.5</p>		<p>From under the water one swimmer pushes and throws (disconnects with) an upper (visible) swimmer who becomes <u>airborne</u>. The upper (visible) swimmer jumps backwards, twists 180° in the air, and then enters the water.</p>	<p><b>1.60</b></p>	<p><b>1.70</b></p>
<p><b>37</b></p>	<p>Throw legs-up with 180 somersault and half twist</p> <p>WIs0.5t0.5</p>		<p>From under the water one swimmer pushes and throws (disconnects with) the upper (visible) swimmer who becomes <u>airborne</u>. This upper (visible) swimmer starts their action feet-first and by lifting their body and tucking, performs 0.5 (half) somersault with simultaneous turn on 180° in the air before entering the water.</p>	<p><b>1.60</b></p>	<p><b>1.70</b></p>
<p><b>38</b></p>	<p>Jump head-up with 1 somersault backwards</p> <p>Js1B</p>		<p>From under the water one swimmer pushes and throws (disconnects with) an upper (visible) swimmer who becomes <u>airborne</u>. The upper (visible) swimmer performs 1 backwards somersault (360°) in the air demonstrating "tuck" position before entering the water</p>	<p><b>1.80</b></p>	<p><b>1.90</b></p>
<p><b>39</b></p>	<p>Throw legs up with flexibility and rotation 540°</p> <p>Wlfr1.5</p>		<p>From under the water one swimmer pushes and throws (disconnects with) and upper (visible) swimmer who becomes <u>airborne</u>. The upper visible swimmer starts their action feet first and demonstrating flexibility position/s during maximum height. The upper (visible) swimmer then submerges while simultaneously rotating 540 degrees or more.</p>	<p><b>1.80</b></p>	<p><b>1.90</b></p>



<p><b>40</b></p>	<p>Jump - Tuck - 1 somersault half twist</p> <p><b>JBs1t0.5</b></p>		<p>From under the water one swimmer pushes and throws (disconnects with) an upper (visible) swimmer who becomes <u>airborne</u>. The upper (visible) swimmer performs 1 backwards somersault (360°) and half twist (180°) around themselves in the air demonstrating "tuck" position before entering the water.</p>	<p><b>2.00</b></p>	<p><b>2.10</b></p>
<p><b>41</b></p>	<p>Jump head-up with 1 somersault backwards and flexibility</p> <p><b>Jfs1B</b></p>		<p>From under the water one swimmer pushes and throws (disconnects with) an upper (visible) swimmer who becomes <u>airborne</u>. The upper (visible) swimmer performs 1 backwards somersault in the air demonstrating flexibility of their body (ring position and variations) before entering the water.</p>	<p><b>2.00</b></p>	<p><b>2.10</b></p>
<p><b>42</b></p>	<p>Jump head-up with 1 somersault forwards</p> <p><b>Js1F</b></p>		<p>From under the water one swimmer pushes and throws (disconnects with) an upper (visible) swimmer who becomes <u>airborne</u>. The upper (visible) swimmer performs 1 forwards somersault in the air before entering the water.</p>	<p><b>2.00</b></p>	<p><b>2.10</b></p>
<p><b>43</b></p>	<p>Jump head-up with 1 somersault backwards and open in Jay (flexibility)</p> <p><b>Js1B+f</b></p>		<p>From under the water one swimmer pushes and throws (disconnects with) an upper (visible) swimmer who becomes <u>airborne</u>. The upper (visible) swimmer jumps backwards, tucking and rotating 180° in the air, then turning another 180° while opening to a Jay (flexibility) position before entering the water.</p>	<p><b>2.10</b></p>	<p><b>2.20</b></p>

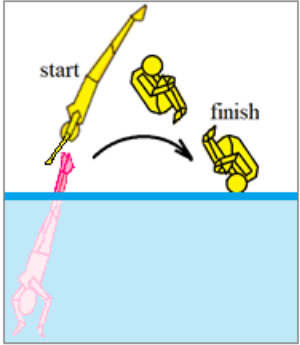

<p><b>44</b></p>	<p>Jump head-up with 1 somersault backwards+Pike + open in Jay (flexibility)</p> <p><b>Js1B+pf</b></p>		<p>From under the water one swimmer pushes and throws (disconnects with) an upper (visible) swimmer who becomes airborne. The upper (visible) swimmer jumps backwards, piking, rotating 180° in the air and then rotates another 180° while opening into a Jay (flexibility) position before entering the water</p>	<p><b>2.15</b></p>	<p><b>2.25</b></p>
<p><b>45</b></p>	<p>Throw legs-up with 1 somersault forwards</p> <p><b>W!s1F</b></p>		<p>From under the water one swimmer pushes and throws (disconnects with) an upper (visible) swimmer who becomes airborne. This upper (visible) swimmer starts their action feet-first and by lifting their torso performs 1 somersault forwards (360°) in the air before entering the water.</p> <p>Note: the somersault is usually performed in a tuck position.</p>	<p><b>2.20</b></p>	<p><b>2.30</b></p>
<p><b>46</b></p>	<p>Jump head-up-Backwards-Frontal 360 somersault</p> <p><b>JsF1B</b></p>		<p>From under the water one swimmer pushes and throws (disconnects with) an upper (visible) swimmer who becomes airborne. The upper (visible) swimmer jumps backwards, turns 90 degrees in the air and performs 1 side (frontal) somersault (360°) in the air demonstrating "tuck", "pike" or "variant of pike" position before entering the water.</p>	<p><b>2.20</b></p>	<p><b>2.30</b></p>

**Pair Assisted Actions**

THIS IS A LIST OF PAIR ASSISTED ACTIONS (FOR YOUR INFORMATION). THEY ARE NOT CONSIDERED AS A PAIR ACROBATIC MOVEMENTS. THEY ARE CONSIDERED IN TRANSITIONS (ARTISTIC IMPRESSION) IN DUETS OR TEAMS.

In pair assisted actions, the bottom (base) swimmer may remain under the surface of the water or on the surface, but the featured-swimmer always remains on the surface (not lifted up). Also, "boost-type" assisted movements are considered as pair assisted actions.

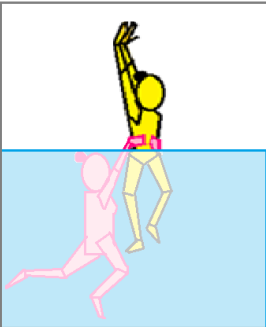
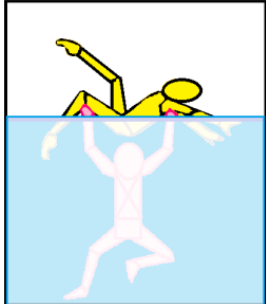
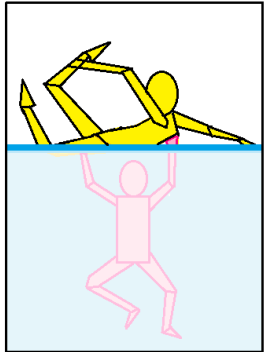
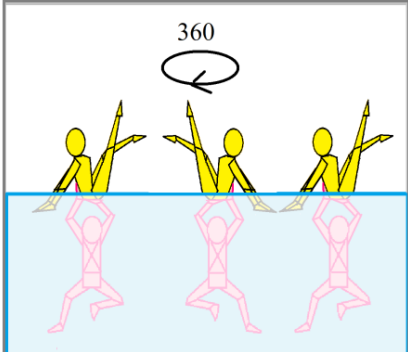
Name	Diagram	Description
<b>Pair assisted action "boost type"</b>		<p>One swimmer remains under the water and lifts another swimmer who performs actions above the surface of the water. This action should demonstrate a boost of a "visible" swimmer to maximum height (crotch level) with assistance of the "underwater" swimmer.</p>
<b>Pair assisted action on the surface ("float")</b>		<p>One swimmer remains under the water and holds another swimmer who remains on the surface and performs actions.</p>
<b>Pair assisted action on the surface ("float") with flexi- bility</b>		<p>One swimmer remains under the water and holds another swimmer who remains on the surface and performs movements with a range of flexibility (such as: Split, Ariana, Ring etc.)</p>
<b>Pair assisted action on the surface with rotation 180°-360°</b>		<p>One swimmer remains under the water and holds and rotates another swimmer (upper visible swimmer) 180-360 degrees who remains on the surface of the water.</p>



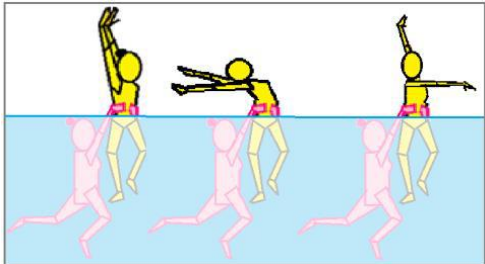
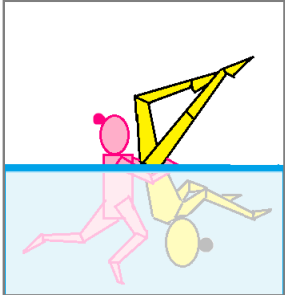
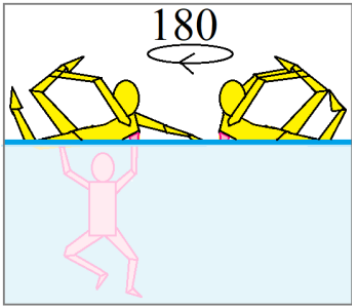
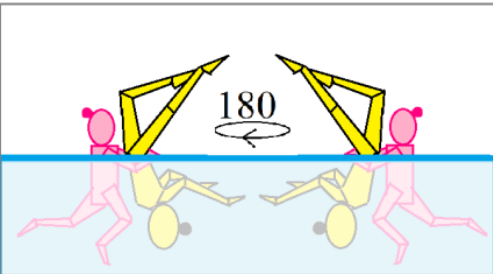
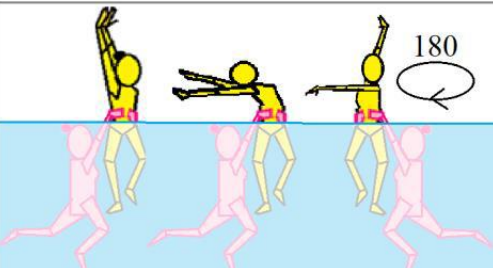

<p><b>Sustained assisted action head-up</b></p>		<p>One swimmer remains under the water and lifts another swimmer who performs actions above the surface of the water sustained for 3 seconds or more.</p>
<p><b>Sustained assisted action legs-up</b></p>		<p>One swimmer holds another swimmer whose position is head-down and sustained for 3 seconds or more.</p>
<p><b>Pair assisted action on surface with flexibility and rotation 180°-360°</b></p>		<p>One swimmer remains under the water and holds and rotates another swimmer (upper visible swimmer) 180°-360° who remains at the surface and performs movements with a range of flexibility (such as: split, Ariana, ring etc.).</p>
<p><b>Sustained assisted action legs-up with rotation 180°-360°</b></p>		<p>One swimmer holds another swimmer, whose position is head-down for 3 seconds or more with a simultaneous rotation of 180°-360°. Note: both swimmers rotate in connection one with another.</p>
<p><b>Sustained assisted action head-up with travelling and rotation 180°-360°</b></p>		<p>One swimmer remains under the water and lifts another swimmer holding for 3 seconds or more while travelling. The upper swimmer performs some actions above the water at maximum height with a rotation of 180°. When the bottom swimmer pushes and releases support the upper swimmer submerges under the water. Note: the rotation must happen during "maximum height" phase.</p>



**29.8 APPENDIX 8 - IDENTIFICATION OF SYNCHRONISATION ERRORS**

**29.8.1 Scoring Synchronisation**

**Introduction**

The synchronisation panel, comprised of three synchronisation technical controllers, will operate only in Duet and Team routines (Team Technical, Team Free, Free Combination and Acrobatic).

The goal is to objectively identify synchronisation errors during the routine performance and calculate deductions accordingly.

**Definition of Synchronisation:**

Synchronisation is the precision of movements in unison one with the other/s. It means to have actions happen at the same time or correspond exactly in design.

It can also be understood as an UNEQUAL ACTION (or accuracy error) when comparing two or more athletes swimming at the same time. Unequal actions can be due to timing and/or design errors of the movements that make the "picture" not precise, accurate and/or perfect to what the choreography is demonstrating.

**Definition of an UNEQUAL ACTION:**

Is any movement performed by two or more swimmers that is performed with a difference in timing or positioning (design/shape). Movements that are choreographed as intentional unequal movements shall not be penalized.

A difference in timing:

Movements are not performed in complete unison one with the other(s).

Actions do not happen at the exact same time.

A difference in positioning (design/shape):

There is a difference in position of head, arms, legs or other body parts used.

There is a difference in water level of head, arms, legs or other body parts used.

There is a difference in spacing and pattern shape.

Note: *When you observe two or more swimmers showing different positioning – it is unknown which was the intended or correct one, that is, you do not know who made the error but you can clearly see a difference, and this is an unequal action.*

An example of a difference in positioning:



Fig 1: The pattern, direction of the legs and height of the legs are not showing a "perfect picture" of what we should be watching. As this is just a photo, we can't speak about timing differences here.

**General principles in Regard to Synchronisation errors**

- 1) Synchronisation Technical Controllers start to count unequal actions when the music accompaniment begins.
- 2) When a timing error and a positioning error (shape/design) occur simultaneously, controllers will only register ONE synchro error (unequal action).
- 3) For those movements and positions for which there is a precise indication regarding degrees of deviation in execution (i.e Vertical Position and Vertical descent, perpendicular leg of Ballet Leg Position, Knight Position, Fishtail/Crane), Elements judges will also take this into account in their execution mark.
- 4) Routines will have as many errors counted as are observed by the synchronisation controllers and validated by the system – therefore unlimited. It can be more than one during the same hybrid or transition sequence. This means that each movement is susceptible to generate a synchro error (unequal action). Two of the most significant examples of continued accumulation of deductions are:

A hybrid beginning unsynchronised and keeping a timing difference until the end. Each movement delayed will be counted as a synchro error (unequal action).

A rotation where a difference in timing or positioning may occur during the entire rotation. It is stated in the Introductory Guide for the Application of Declared Difficulty that each 180° rotation is considered as one movement, and therefore a difference in timing maintained from beginning to end of a 720° spin (or twist) could accumulate a maximum of 4 unequal actions (either small or obvious).

- 5) When movements are very fast the controller registers as many unequal actions as seen with the time limitation of the validation system; that is: controllers can only register one unequal action approximately every 0.5 seconds.

**Definitions of Synchronisation Errors**

Synchronisation errors are defined in THREE categories – Small, Obvious or Major:

<b>Small</b>	<p><b>Slight differences that cannot be considered as two different movements but distort the image of perfect synchronisation.</b></p>
	<p>Small synchronisation errors include:</p> <ul style="list-style-type: none"> <li>Slight differences in timing</li> <li>All differences in positioning (design/shape) will be considered as a small error (as they are also considered by Elements panel) <ul style="list-style-type: none"> <li>Non-accurate movements in pattern alignment and spacing</li> <li>Differences in angles or height</li> <li>Non-parallel walkouts</li> </ul> </li> </ul> <p>Examples of small synchro errors: <a href="https://vimeo.com/646159124/b2f4ba969a">https://vimeo.com/646159124/b2f4ba969a</a></p>
<b>Obvious</b>	<p><b>Any unintentional difference in matching that produces the effect of two movements being done one after the other.</b></p>
	<p>Obvious synchronisation errors include:</p> <ul style="list-style-type: none"> <li>Clear difference in timing (one after the other)</li> </ul> <p>Examples of obvious synchro errors: <a href="https://vimeo.com/646160065/6b4fcec916">https://vimeo.com/646160065/6b4fcec916</a></p>
<b>Major</b>	<p><b>Any error that produces an alteration in routine content (missing one or more movements by one or more swimmers).</b></p>
	<p>Major synchronisation errors include:</p> <ul style="list-style-type: none"> <li>An alteration of the routine content by one or more athletes (missing movements).</li> <li>Any alteration (missing movement) counts as a major error – for example even if it's just one quick backstroke that is missed by an athlete.</li> <li>All major errors must have video review overseen by the Referee since they result in the largest deduction. They ensure process is followed and does not participate in any decision making regarding the major error(s).</li> </ul> <p>Examples of major synchro errors: <a href="https://vimeo.com/646160851/ac1a25b6e2">https://vimeo.com/646160851/ac1a25b6e2</a></p>



*\*NOTE: When you are watching different routines, you might feel that some of the errors observed as “Small” in younger/developing athletes, may be considered “Obvious” in older/experienced athletes/routines. This is due to the length of time of the counting/speed of movement - speed adds more risk to synchronisation.*

For example: when athletes are working at faster speeds (such as 4 movements per second), there's more risk to make “Obvious” errors (visual two different movements) than when routines are slower (such as one movement per second). Movements done one per second, need a complete second difference to appear to be two different movements.

## **29.8.2 Procedures**

### **Using a Synchronisation Application or Device**

How we calculate the final result for the synchronisation panel:

There will be one panel of three synchronisation technical controllers, each of them with a synchronisation application (via tablet)/or a device with three buttons. Each “button” will have a different colour:

**Green** will be pressed for small errors.

**Yellow** will be pressed for obvious errors.

**Red** will be pressed for major errors.

The average of small and obvious errors of the three STCs will be calculated to be applied for the synchro error deduction. If major errors are identified by the STCs the deduction will be applied following the process as per section C below.

### **Paper and pencil method (No access to application/device)**

If the implementation of the synchro application or device is not possible then a “paper and pencil” method can be used by the panel of synchronisation controllers.

For this method a printed one-page chart should be made for each synchro controller with three columns – one for small errors, one for obvious errors and one for major errors. Please see the end of the document for the World Aquatics template.

Synchro controllers then mark each small (S), obvious (O) and major (M) error they identify with a checkmark. Each controller then adds up their total number of errors. The average across the three STCs is taken of the small and obvious errors, and then is submitted to the scorer to be inputted for the synchro error deduction. Process for major errors to follow section C below.

### **Review of Major Synchronisation errors**

- 1) If a STC logs a major error, video review by the entire STC panel will take place and will be overseen by the Referee who ensures process is followed and does not participate in any decision making regarding the major error(s).
- 2) In the case where the synchro device is in place the Referee will automatically see that a major error has taken place and will initiate the video review.
- 3) In the case where technology is not in place (pencil and paper method), the STC should communicate to the Referee that they have logged a major error.
- 4) The Referee then oversees the review of the major error(s) with the STC panel by video review.
- 5) The video may only be reviewed a maximum of one (1) time in slow motion (for each part with the major error(s) identified).



- 6) In order for a major error to be applied or the review to be dismissed, two of the three STCs must be in agreement.
- 7) At the conclusion of the review the Referee will communicate the final decision of the STC panel regarding major errors to the Scorer.

### Deductions

Predetermined deduction values for each validated unequal action:

<b>Small</b>	-0.1
<b>Obvious</b>	-0.5
<b>Major</b>	-3.0

The total of synchronisation errors will then be deducted from the elements score.

### Calculation examples

		<b>Small Errors</b>	<b>Obvious Errors</b>	<b>Major Errors</b>
ROUTINE A	STC-1	14	3	0
	STC-2	16	4	0
	STC-3	12	2	0
	Average:	14	3	0
	Deduction:	$14 \times 0.1 = 1.4$	$3 \times 0.5 = 1.5$	$0 \times 3.0 = 0$
	<b>Total:</b>	<b>2.9</b>		
ROUTINE B	STC-1	20	5	2
	STC-2	17	7	1
	STC-3	24	4	2
	Average:	20.3	5.3	2 (video review*)
	Deduction:	$20.3 \times 0.1 = 2.03$	$5.3 \times 0.5 = 2.67$	$2 \times 3.0 = 6.0^*$
	<b>Total:</b>	<b>10.7</b>		

*\*NOTE: entering a major error would trigger a video review, and in this example upon review it would be determined by the STC panel (with the Referee observing and ensuring process is followed as per section C above) that there were 2 major errors, and the Referee would confirm this deduction to the Scorer.*

**SYNCHRONISATION TECHNICAL CONTROLLER FORM**

<b>Competition:</b>				
<b>Age Group:</b>				
<b>Event:</b>	<input type="checkbox"/> Duet Tech	<input type="checkbox"/> Mixed Duet Tech	<input type="checkbox"/> Team Tech	<input type="checkbox"/> Acrobatic
	<input type="checkbox"/> Duet Free	<input type="checkbox"/> Mixed Duet Free	<input type="checkbox"/> Team Free	<input type="checkbox"/> Combo

**Controller Name:** \_\_\_\_\_ **Controller:** **STC1** **STC2** **STC3**

<b>Competitor No:</b>		
<b>Small</b>	<b>Obvious</b>	<b>Major</b>
<b>Total:</b>	<b>Total:</b>	<b>Total:</b>

**29.9 APPENDIX 9 - ARTISTIC SWIMMING WORLD RANKING**
**29.9.1 Definition, Goal & Purposes**

The Artistic Swimming World Ranking is a numerical representation (Numeric value #0) of athletes, duets and teams' performance and consistency among the past twenty-four (24) months. An objective merit-based method has been defined to ensure equality, fairness and competitiveness.

Some of the purposes of the Artistic Swimming World Ranking are the following:

- 1) Recognize and allow all Artistic Swimming athletes to be listed on the World Rankings based on the criteria.
- 2) Determine the start order of Artistic Swimming competition's start lists.
- 3) Help National Federations to use the World Rankings as a tool to decide team selections.
- 4) Serve as qualification criteria for major World Aquatics competitions in the future.

**29.9.2 Eligibility**

As soon as an athlete achieves a result in a competition classified as Tier 2 or Tier 1, he/she shall be included in the World Ranking.

Solo and Duet Rankings belong to the athletes competing who earned the ranking. Each soloist or duet must create their own World Ranking. Each Duet Ranking will also consider the reserve. Soloists' reserves will not be considered.

Team Rankings belong to each National Federation only if at least half (50%) of the Team composition matches, including the reserves.

**29.9.3 Ranking method**
**29.9.3.1 Rolling System**

The Artistic Swimming World Ranking is based on a rolling twenty-four (24) months, considering the best performance achieved:

Given the above, and considering that the World Ranking started with World Aquatics Championships - Doha 2024, the first twenty-four (24) months will expire as per the following table (and then it will continue rolling):

	<b>Finals Event Date</b>	<b>24 months rolling</b>
<b>Women Solo Free</b>	06/02/2024	05/02/2026
<b>Women Solo Technical</b>	03/02/2024	02/02/2026
<b>Men Solo Free</b>	07/02/2024	06/02/2026
<b>Men Solo Technical</b>	05/02/2024	04/02/2026
<b>Women Duet Free</b>	08/02/2024	07/02/2026
<b>Women Duet Technical</b>	05/02/2024	04/02/2026
<b>Mixed Duet Free</b>	10/02/2024	09/02/2026
<b>Mixed Duet Technical</b>	04/02/2024	03/02/2026
<b>Team Free</b>	09/02/2024	08/02/2026
<b>Team Technical</b>	06/02/2024	05/02/2026
<b>Team Acrobatic</b>	04/02/2024	03/02/2026

**29.9.3.2 Competition Level Value**

A different number of points will be distributed among all athletes who achieve a result in a competition, depending on its level, as per World Aquatics Competition Regulations Part 1 – 2.2.1:

**Tier 1.** Major Aquatics Competitions - the Olympic Games, World Aquatics Championships.

**Tier 2.** Artistic Swimming World Cup.

**Tier 3.** Continental Competitions - Continental Multi-Sport Games, Competitions organized by Continental or Organisations. These competitions will be considered at a later stage once World Aquatics has agreed upon the criteria and entered into a partnership with all Continental Associations to ensure the uniform application of the Competition Regulations.

Competition level	Tier value [ $TV^j$ ]
Tier 1	100
Tier 2	90
Tier 3	70

**29.9.3.3 Ranking Calculation**

There is one World Artistic Swimming Ranking per event:

- One (1) World AS Ranking for Women Solo Free
- One (1) World AS Ranking for Women Solo Technical
- One (1) World AS Ranking for Men Solo Free
- One (1) World AS Ranking for Men Solo Technical
- One (1) World AS Ranking for Women Duet Free
- One (1) World AS Ranking for Women Duet Technical
- One (1) World AS Ranking for Mixed Duet Free
- One (1) World AS Ranking for Mixed Duet Technical
- One (1) World AS Ranking for Mixed Team Free Routine
- One (1) World AS Ranking for Mixed Team Technical Routine
- One (1) World AS Ranking for Mixed Team Acrobatic Routine

The rankings are created by weighting the scores according to the Competition Level Value. The final points [ $P_i$ ] to be considered for the rank will be get from:

$$P_i = TV^j \cdot p_i^j$$

Where:

$p_i^j$ : points achieved by Soloist/Duet/Team [ $i$ ] at competition [ $j$ ].

$TV^j$ : competition [ $j$ ] value based on its Tier value [ $TV^j$ ].





#### **29.9.3.4 Ranking Application**

The World Rankings are used to determine the first phase (Preliminaries, if applicable, or Finals if the competition does not have both phases) of all events' start orders:

Start Lists will be created during the Artistic Swimming Technical Meeting based on the World Ranking. The better Soloist/Duet/Team rank, the higher start order will get. Participants without a World Ranking are to be drawn randomly and are to receive the higher start order in the competition:

- Thirty (30) entries in World Aquatics Championships - Women Technical Duet Event: eighteen (18) ranked duets and twelve (12) non-ranked duets.
- Draw Procedure: non-ranked duets will draw for start order one (1) to start order twelve (12) based on a random draw.
- Ranked duets will compete in reverse order of the World Ranking order: from start order thirteen (13) to start order thirty (30).

#### **29.9.3.5 Tie-break Rules**

In case of a tie in the Artistic Swimming World Ranking, it will be broken based on World Aquatics Championships' scores:

- 1) If both of the tied Soloist/Duet/Team participated in the last World Aquatics Championships, the one that achieved a better result will get a higher rank.
- 2) If one the tied Soloist/Duet/Team did not participate in the last World Aquatics Championships, the one that did participate will be ranked higher.
- 3) If none of the tied Soloist/Duet/Team participated in the last World Aquatics Championships, the one that achieved a higher score within the twenty-four (24) months will get a higher rank. This is also applicable if, for any reason, a World Aquatics Championship cannot be considered.

#### **29.9.3.6 Other Considerations**

##### **Scores' Phases Considered**

The last score obtained is the one considered for the World Ranking:

- If a Soloist/Duet/Team participated in both Preliminaries and Finals, only results achieved in the Final will be taken for the World Ranking calculation.
- If a Soloist/Duet/Team does not make the Finals, the Preliminary result will be used for the World Ranking calculation.

##### **Participation**

Competitions will be considered for the World Ranking only if an athlete get a result. Should an athlete be:

- 1) disqualified for breach of World Aquatics competition rules (DSQ);
- 2) disqualified for unsportsmanlike behaviour (DQB);
- 3) did not start (DNS);

then the competition will not be considered.



WORLD  
AQUATICS

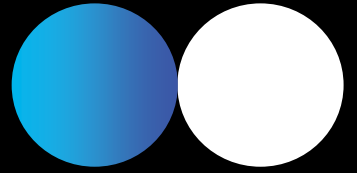

# MASTERS

COMPETITION  
REGULATIONS

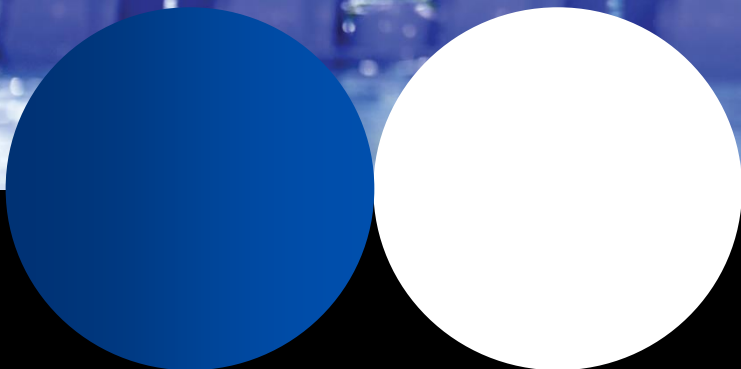



## TABLE OF CONTENTS

### PART EIGHT: MASTERS RULES

PART EIGHT: MASTERS RULES.....	508
<b>1</b> GENERAL.....	508
<b>2</b> MASTERS GENERAL RULES.....	508
<b>3</b> MASTERS SWIMMING RULES.....	509
<b>4</b> MASTERS OPEN WATER SWIMMING RULES.....	512
<b>5</b> MASTERS DIVING RULES.....	513
<b>6</b> MASTERS WATER POLO RULES.....	515
<b>7</b> MASTERS ARTISTIC SWIMMING RULES.....	515
<b>8</b> WORLD AQUATICS MASTERS CHAMPIONSHIPS.....	517



## PART EIGHT: MASTERS RULES

### 1 GENERAL

The Masters program shall promote fitness, friendship, understanding and competition through Swimming, Diving, Artistic Swimming, Water Polo and Open Water Swimming among competitors with a minimum age of 25 years (note: exception in Part Eight, Article 6.1.3).

The Technical Rules for the different sports (SW, OW, DV, WP and AS) in the Competition Regulations shall be followed with exceptions mentioned in this Masters part of the Competition Regulations.

### 2 MASTERS GENERAL RULES

**2.1** The Members shall register Masters Competitors in a special category for each of the five recognised sports. A competitor who registers for Masters in any sport will still retain his/her unrestricted right to compete in other competitions.

**2.2** Except for specific exceptions in the World Aquatics Rules and regulations all other World Aquatics Rules and Regulations shall apply to Masters Competitions.

**2.3** Individual entries shall only be accepted from persons representing clubs. No swimmer or team may be designated as representing a country or Federation.

**2.4** Age shall be determined as of December 31 of the year of competition.

**2.5** Masters Competitors must be aware of the need of being well prepared and medically fit before entering into Masters Competitions. They shall assume full responsibility for the risks included in competing in such competitions. In consideration of their entry, they must agree to waive and release World Aquatics, the Organising National Federation and the Organising Committee from any kind of liability for accidents, which may cause death, injury or property loss. Entry Forms containing a warning of the risks, an Accident Waiver and Release of Liability must be signed by each Masters competitor.

#### **2.6 Protests**

**2.6.1** Protests are possible:

- (a) if the rules and regulations for the conduct of the competition are not observed;
- (b) if other conditions endanger the competitions and/or competitors; or
- (c) against decisions of the referee; however, no protest shall be allowed against decisions of fact.

**2.6.2** Protest must be submitted

- (a) to the referee,
- (b) in writing on World Aquatics Forms,
- (c) by the participant,
- (d) together with a deposit of 100 US Dollars or its equivalent, and
- (e) within 30 minutes following the conclusion of the respective event or match.

If conditions causing a potential protest are noted prior to the event a protest must be lodged before the signal to start is given.

**2.6.3** All protests shall be considered by the referee. If the referee rejects the protest, referee must state the reasons for her/his decision to the participant.

As a last recourse, at the World Aquatics Masters Championships, the participant can then submit his protest to the World Aquatics Masters Committee. The World Aquatics Masters Committee shall consider the protest and give the final decision.



- 2.6.4** If the protest is rejected, the deposit will be forfeited to the management body of the competition. If the protest is upheld, the deposit will be returned.

### **3 MASTERS SWIMMING RULES**

The Swimming Rules in Part II of these Competition Regulation apply to Masters with the following exceptions:

#### **3.1 Age Groups**

##### **3.1.1 Individual Events:**

25 – 29, 30 – 34, 35 – 39, 40 – 44, 45 – 49, 50 – 54, 55 – 59, 60 – 64, 65 – 69, 70 – 74, 75 – 79, 80 – 84, 85 – 89, 90 – 94 ... (five year age groups as high as is necessary).

##### **3.1.2 Relays:**

For all purposes pertaining to Masters meet competition, the actual attained age of the competitor shall be determined as of December 31st of the year of competition.

#### **3.2 Events**

The following events may be conducted for each age group.

##### **3.2.1 Short course (25 m)**

50, 100, 200, 400, 800, 1500m – **Freestyle**

50, 100, 200m – **Backstroke**

50, 100, 200m – **Breaststroke**

50, 100, 200m – **Butterfly**

100, 200, 400m – **Individual Medley**

4 x 50m – **Freestyle Relay**

4 x 50m – **Medley Relay**

4 x 50m – **Mixed Freestyle Relay (2 women and 2 men)**

4 x 50m – **Mixed Medley Relay (2 women and 2 men)**

4 x 100m – **Freestyle Relay**

4 x 100m – **Medley Relay**

4 x 100m – **Mixed Freestyle Relay (2 women and 2 men)**

4 x 100m – **Mixed Medley Relay (2 women and 2 men)**

4 x 200m – **Freestyle Relay**

4 x 200m – **Mixed Freestyle Relay (2 women and 2 men)**

##### **3.2.2 Long course (50 m)**

50, 100, 200, 400, 800, 1500m – **Freestyle**

50, 100, 200m – **Backstroke**

50, 100, 200m – **Breaststroke**

50, 100, 200m – **Butterfly**

200, 400m **Individual – Medley**

4 x 50m – **Freestyle Relay**

4 x 50m – **Medley Relay**

4 x 50m – **Mixed Freestyle Relay (2 women and 2 men)**

4 x 50m – **Mixed Medley Relay (2 women and 2 men)**



4 x 100m – **Freestyle Relay**

4 x 100m – **Medley Relay**

4 x 100m – **Mixed Freestyle Relay (2 women and 2 men)**

4 x 100m – **Mixed Medley Relay (2 women and 2 men)**

4 x 200m – **Freestyle Relay**

4 x 200m – **Mixed Freestyle Relay (2 women and 2 men)**

### **3.3 Masters Swimming Technical Rules**

**3.3.1** Age groups and sexes may be combined so that no swimmer has to swim alone and lanes may be filled.

#### **3.3.2 Start**

**3.3.2.1** When using the forward start, the referee's whistle shall indicate that the swimmers may take their positions with at least one foot at the front of the starting platform or pool deck, or in the water with one hand having contact with the starting wall.

**3.3.2.2** When all swimmers are ready (instead of stationary) to start the starter shall give the starting signal.

**3.3.2.3** Any swimmer(s) starting before the starting signal may be disqualified upon the completion of the race.

**3.3.3** All Masters events shall be conducted on a timed final basis.

**3.3.4** Swimmers may be allowed to remain in their lane while other swimmers are competing until directed by the referee to exit the pool.

**3.3.5** The Organising Committee may arrange 400 metre, 800 metre and 1500 metre Freestyle to be swum two (2) swimmers of the same sex in a lane. Separate timing will be required for each swimmer.

**3.3.6** The Warm Up must be supervised.

**3.3.7** A breaststroke kicking movement is permitted for butterfly. Only one breaststroke kick is permitted per arm pull except that a single breaststroke kick is permitted prior to the turn and the finish without an arm pull. After the start and after each turn, a single breaststroke kick is permitted prior to the first arm pull.

**3.3.8** Swimmers who had to be disqualified must be listed with coded reason for disqualification in the results list.

#### **3.4 Relays**

**3.4.1** Relays shall consist of four swimmers each registered with the same club. No swimmer is allowed to represent more than one club.

**3.4.2** MIXED Relays consist of two (2) female and two (2) male each registered with the same club. No swimmer is allowed to represent more than one club.

#### **3.5 Records**

**3.5.1** Masters World Records for all events listed in Part Eight, Article 3.2 for both sexes in each age group shall be recognised and maintained in 1/100 second time (2 decimal places) and according to the provisions listed on the application form. World Records will be accepted only when times are recorded by Automatic Officiating Equipment, or Semi- Automatic Officiating Equipment in case of Automatic Officiating Equipment system malfunction.

**3.5.2** Applications for Masters World Records must be made on the World Aquatics official forms by the individual in question within 60 days from the end of the event.

**3.5.3** World Records can only be established in a Masters meet:

- a) formally sanctioned by a World Aquatics Member Federation; and
- b) organised for on behalf of a club or an organisation, which is a member of this World Aquatics Member Federation or recognised by World Aquatics; and
- c) conducted under the rules of World Aquatics (and specially those relevant to Masters Swimming); and
- d) in which only swimmers registered in a club member of a World Aquatics Member Federation participated.



**3.5.4** The first swimmer in mixed relays may apply for a Masters World Record.

### **3.6 Masters Swimming World Records Application Instructions**

#### **3.6.1 General**

World Records for Masters are recognized by World Aquatics in both Long Course (50 metre pools only) and Short Course (25 metre pool only). Performance must be registered at a Masters meet as per Rule VIII.3.5.3.

#### **3.6.2 Events and Age Groups**

##### **3.6.2.1.1 Individual Events - for Men and Women**

Freestyle – 50m, 100m, 200m, 400m, 800m and 1500m; Backstroke, Breaststroke and Butterfly – 50m, 100m and 200m; Individual Medley – 100m (Short Course only), 200m and 400m.

##### **3.6.2.2 Age Groups**

25 – 29, 30 – 34, 35 – 39, 40 – 44, 45 – 49, 50 – 54, 55 – 59, 60 – 64, 65 – 69, 70 – 74, 75 – 79, 80 – 84, 85 – 89, 90 – 94, 95 – 99, 100 – 104, ... (five year age groups as high as is necessary).

##### **3.6.2.3 Relay Events - for Men, Women and Mixed (2 men and 2 women)**

4x50m Freestyle, 4x50m Medley, 4x100m Freestyle, 4x100m Medley, 4x200m Freestyle

Relay Age Groups are calculated from the total age of team members (in whole years) 100 – 119 years, 120 to 159 years, 160 – 199 years, 200 to 239 years, 240 – 279 years, 280 to 319 years, 320 – 359 years, 360 to 399 years, ...(forty year increments as high as is necessary).

#### **3.6.3 Eligibility**

All applicants must be financial members of a Federation affiliated with World Aquatics. Relay teams must be made up of four swimmers each properly registered with a single club. Swimmers may swim for only one club at any particular meet.

#### **3.6.4 Timing**

- 10) Only electronic timing will be accepted. OR
- 11) Semi-Automatic Timing in the case of where the Automatic Timing system malfunctioned
- 12) Meet timing record or photocopy is to be attached to the application form.

#### **3.6.5 Age Determining Date**

For all purposes pertaining to Masters World Records and Masters World Championship meets, the actual attained age of the competitor as of 31 December of the year of the meet shall determine their age group for that competition and any record set during that competition.

#### **3.6.6 Applications**

Applications for records should be placed on World Aquatics Masters Swimming World Record Application Forms by the Meet Director and submitted within sixty (60) days of the event. The application is to be endorsed by either the Chief Timekeeper or the Referee of the meet. The National Federation is to verify the details of the applicant and ensure that all documentation is complete including:

- a) Certification of pool length;
- b) Proof of date of birth; and
- c) Timing record.

The application should be forwarded to the World Aquatics Office located at:

**Chemin de Bellevue 24a / 24b**  
**1005 Lausanne Switzerland**  
**Email: [masters@worldaquatics.com](mailto:masters@worldaquatics.com)**

World Aquatics will decide whether to approve the record application. The World Aquatics Office will inform the National Federation of the results of each application. If after publication an error is detected, the swimmers have the right to appeal for a correction within 6 months of the publication date.

##### **3.6.6.1 Detailed Instructions**



**Point 1** If the Record Application is for an Individual Event, then enter that Event Name from the above list item # 2.1. If it is for a Relay Event then enter that Event Name from the above list item # 2.2. Circle either Men, Women or Mixed.

**Point 2** Enter the Official Time in minutes, seconds and 1/100th of second without rounding.

**Point 3** If the Record Application is for an Individual Event then enter the Age Group from the above list item 2.1. If for a Relay Event then enter the Age Group from the above list item 2.2.

**Point 4** Identify the Course Type as either Short Course 25 metres or Long Course 50 metres.

**Point 5** Enter the Pool Name, City, Country and Date of the Official Sanctioned Masters Meet.

**Point 6** A copy of the pool length confirmation must either be attached with this application or already on file with the World Aquatics Masters Recorder. A one-time measurement is required unless there are changes to the pool that might cause the pool measurements to change. Then the pool length must be confirmed again. Where a moveable bulkhead is used, it is not necessary for an additional course measurements confirmation of the lane where the time was achieved.

**Point 7** If an Individual Event then list the swimmer's first name then last name, circle M for Men or W for Women, enter age (see item 5 above) and the full date of birth including the name of the month.

**Point 8** If this record is for a Relay then list each member of the relay in the order they swam. List the swimmer's first name then last name, circle M for Men or W for Women, enter age (see item 5 above) and the full date of birth including the name of the month.

**Point 9** A copy of each swimmer's birth certificate or passport must either be attached with this application or already on file with the World Aquatics Masters Recorder. A marriage certificate is not required.

**Point 10** Enter the Club name of the individual swimmer or relay team and the Federation that this club is affiliated with.

**Point 11** Enter the Official Time from the Primary Automatic Officiating Equipment. The time is entered in minutes, seconds and 1/100th second without rounding.

**Point 12** If the primary Automatic Officiating Equipment malfunctions then enter the times from the Backup Semi-Automatic Officiating equipment. The times are entered in minutes, seconds, 1/100th second without rounding.

**Point 13** A printed copy from the Automatic Officiating Equipment is required. The printout must show the details including all backup times from the specific heat where the record occurred. Meet results with splits are not acceptable.

**Point 14** Enter the Name and Title of the Certifying Official. A signature and date is required.

**Point 15** The National Masters Recorder for the Federation where the swimmer(s) is affiliated must enter the Name and Federation. A signature and date is required.

### **3.7 Appendix - Ruling for Masters Top Ten tabulations.**

Results that are valid for the World Aquatics Masters Top Ten results can only be established in a Masters meet:

- a) formally sanctioned by a World Aquatics Member federation;
- b) organised for or on behalf of a club or an organisation which is a member of this World Aquatics Member Federation or recognised by World Aquatics;
- c) conducted under the rules of World Aquatics (and specially those relevant to Masters Swimming); and
- d) in which only swimmers registered in a club member of a World Aquatics Member Federation participated.

## **4 MASTERS OPEN WATER SWIMMING RULES**

Masters Open Water Swimming shall be defined as any event for which the distance is greater than 1500 metres and where entry is restricted to Master swimmers.





The Open Water Swimming Rules in Part Three of these Competitions Regulations shall apply to Masters Open Water Swimming with the following exceptions.

- 4.1** Masters Open Water Swimming events will be up to 5 km.
- 4.2** Age Groups for Open Water Swimming are the same as for Masters Swimming Individual Events (Part Eight, Article 3.1.1).
- 4.3** The water temperature shall be measured within 30 minutes before start of race and must be a minimum of 18°C and maximum of 31°C. The water temperature shall be certified by the Safety Officer as measured in as near to the middle of the course as possible at a depth of 40 cm. If water temperature is below 18°C, the use of wetsuits is compulsory.
- 4.4** It shall be compulsory for all swimmers to wear highly visible coloured swim caps and approved World Aquatics Swimwear.
- 4.5** At all Masters Open Water events the safety of the competition shall be of paramount importance.

## 5 MASTERS DIVING RULES

The Diving Rules in Part Four of these Competitions Regulations shall apply to Masters Diving with the following exceptions.

### 5.1 Age Groups and Events

#### 5.1.1 Springboard Diving – Men and Women (1 metre and 3 metre)

Age Group (Years)	Total Number of Dives required	
	MEN	WOMEN
25 – 29	6	5
30 – 34	6	5
35 – 39	6	5
40 – 44	6	5
45 – 49	6	5
50 – 54	6	5
55 – 59	6	5
60 – 64	6	5
65 – 69	6	5
70 – 74	5	5
75 – 79	5	5
80 +	5	5

(five year age groups as long as necessary)

#### 5.1.2 Platform Diving - Men and Women (5 metre, 7.5 metre, or 10 metre)



Age Groupe (Years)	Total Number of Dives required	
	MEN	WOMEN
25 – 29	6	5
30 – 34	6	5
35 – 39	6	5
40 – 44	6	5
45 – 49	6	5
50 – 54	5x	5x
55 – 59	5x	5x
60 – 64	5x	5x
65 – 69	5x	5x
70 – 74	4x	4x
75 – 79	4x	4x
80 +	4x	4x

(five year age groups as long as necessary)

(x) 10m limited: Only feet first entries are allowed from the 10m platform and any performed dive from the 10m must not exceed degree of difficulty of 2.0.

### 5.1.3 Synchronised Diving

#### 5.1.3.1 3m Springboard – Men and Women and Mixed Team

Age Group (Years)	MEN	WOMEN	MIXED TEAM
50 – 99	2(*) +2	2(*) + 2	2(*) +2
100+	2(*) +2	2(*) +2	2(*) +2

(\*) Degree of difficulty of 2.0 for each dive regardless of the formula for degree of difficulty of the dive.

#### 5.1.3.2 Platform – Men and Women and Mixed Team

Age Group (Years)	MEN	WOMEN	MIXED TEAM
50 – 99	2(*) +2	2(*) + 2	2(*) +2
100+	2(*) +2	2(*) +2	2(*) +2

(\*) Degree of difficulty of 2.0 for each dive regardless of the formula for degree of difficulty of the dive.

**5.1.3.3** The Age Group in Synchronised Diving is decided by adding the ages of the two divers.

**5.1.3.4** If in any of the two groups in Synchronised Diving the age of a diver is 50 years or more, the limitation from 10 m platform dives of only feet first and any dive from 10 m must not exceed degree of difficulty 2.0 applies for the pair.

**5.1.3.5** MIXED TEAM consist one (1) female and one (1) male.

### 5.2 Masters Diving Technical Rules

**5.2.1** The diver can freely choose the dives from the dive table given in these Competitions Regulations. The only requirement is that in age groups 25 – 69 years, each dive performed has different dive number (as to Competition Regulations).

**5.2.2** In age groups 70 and older dives with the same dive number can be repeated, if performed in a different position (straight, pike, tuck or free position).

**5.2.3** Forward facing dives can be performed with or without running approach.

**5.2.4** In synchronised diving events two divers from different clubs within the same Federation are permitted to compete as a synchronised diving team in the 3m springboard and the platform synchronised diving competitions.

**5.2.5** In Synchronised Diving both divers must perform the same dive number and position. Otherwise, the Referees shall declare a failed dive (0 points).



## 6 MASTERS WATER POLO RULES

The Water Polo Rules in Part Six of these Competitions Regulations shall apply to Masters Water Polo with the following exceptions:

### 6.1 Age Groups

**6.1.1** Age groups for Masters Water Polo shall apply for men and women teams.

**6.1.2** The age of the youngest member of the team determines the age group of the team. There are no restrictions on the ages of any players older than the youngest player on the team.

**6.1.3** Age groups for teams are at five-year intervals beginning with 30. i.e. 30+, 35+, 40+, ...

### 6.2 Masters Water Polo Technical Rules

**6.2.1** Each team shall consist of seven players, one of who shall be the goalkeeper and who shall wear the goalkeepers cap, and not more than eight reserves may be used as substitutes, listed on the game roster, which must be submitted to the official's table for each game, not less than 45 minutes before each game commences. All players listed on the game roster will be eligible to play in the game. After the games has commenced, a team playing with less than seven players shall not be required to have a goalkeeper.

**6.2.2** It is not compulsory for a team to name a substitute goalkeeper. A goalkeeper who has been replaced by a substitute may, if the player returns to the game, play in any position.

**6.2.3** Part Six, Article 20.4.4 shall apply except that the goalkeeper shall wear cap no. 1 and the other caps shall be numbered 2 to 15. A substitute goalkeeper shall wear a red cap numbered 13.

**6.2.4** The uniform distance between the respective goal lines shall be 23.5 metres minimum, and the uniform width of the field of play shall be 17 metres minimum.

**6.2.5** Part Six, Article 4.3 time standards shall apply except that the duration of the Masters games shall be four periods of seven minutes each actual play for the 30+, 35+, 40+ and 45+ age groups and six minutes each actual play for the 50+, 55+, 60+, etc. age groups.

**6.2.6** Part Six, Article 7.3 method of scoring shall apply except that the time of possession of the ball shall be 35 seconds.

**6.2.7** There shall be a two minute interval between each period of play. The teams including the players, coaches and team officials, shall change ends before starting the third period.

**6.2.8** Women players may be members of men's teams.

## 7 MASTERS ARTISTIC SWIMMING RULES

The Artistic Swimming Rules in Part Seven of these Competitions Regulations shall apply to all Masters Artistic Swimming except for the following:

### 7.1 Age Groups

**7.1.1 Solo:** 25 – 29, 30 – 39, 40 – 49, 50 – 59, 60 – 69, 70 – 79, 80 and over

**7.1.2 Duet:** 25 – 29, 30 – 39, 40 – 49, 50 – 59, 60 – 69, 70 – 79, 80 and over with age determined by the average age of the competitors.

**7.1.3 Mixed Duet:** 25 – 29, 30 – 39, 40 – 49, 50 – 59, 60 – 69, 70 – 79, 80 and over with age determined by the average age of the competitors.

**7.1.4 Team:** 25 – 34, 35 – 49, 50 – 64, 65 and over with age determined by the average age of the competitors.

**7.1.5 Free Combination:** 25 – 39, 40 – 64, 65 and over with age determined by the average age of the competitors.

**7.1.6** The average age of the competitors in a routine shall be determined by adding the ages of the actual swimmers, dividing by the number of swimmers (not including the reserves) and dropping any resulting fraction or decimal. (For example, if the average age of a Team is 49.833, they would swim in the 35–49 age group).

### 7.2 Events



- 7.2.1** The events of Masters Artistic Swimming are Women Solo, Men Solo, Duet, Mixed Duet, Team and Free Combination.
- 7.2.1.1** Each event constitutes a separate event.
- 7.2.1.2** Team technical, team free and free combination are open to all sexes.
- 7.2.1.3** Mixed Duet is composed of one (1) female and one (1) male.
- 7.2.2** The programme for a Masters Event shall be Technical Routines, Free Routines and Free Combination.
- 7.2.2.1** **Technical Routine**
- The Technical Routines shall be performed for Solo, Duet, Mixed Duet and Team with the required elements selected by World Aquatics Masters Committee every four (4) year, subject to approval by the World Aquatics Bureau. Technical Routines have to include all required elements. Music selection is optional and may be the same as the music used in the Free Routine.
- 7.2.2.2** **Free Routine**
- The Free Routine shall consist of Solo, Duet, Mixed Duet Team, and Free Combination. There are no restrictions regarding selection of music or choreography.
- 7.3** **Competitors**
- 7.3.1** Competitors in Duet, Mixed Duet, Team and Free Combination shall represent the same club.
- 7.3.2** Teams shall consist of a minimum of four (4) members and a maximum of eight (8) members. Combination shall consist of a minimum of four (4) members and a maximum of ten (10) members.
- 7.4** **Masters Artistic Swimming Technical Rules**
- 7.4.1** **Time Limits for Routines**
- Time limits for Technical Routines and Free Routines including ten (10) seconds for the deck movement.
- 7.4.1.1** **Technical Routines Solo:** 2 minutes 00 seconds  
**Free Routines Solo:** 2 minutes 15 seconds
- 7.4.1.2** **Technical Routines Duet:** 2 minute 20 seconds  
**Free Routines Duet:** 2 minutes 45 seconds
- 7.4.1.3** **Technical Routines Mixed Duet:** 2 minutes 20 seconds  
**Free Routines Mixed Duet:** 2 minutes 45 seconds
- 7.4.1.4** **Technical Routines Teams:** 2 minutes 50 seconds  
**Free Routines Teams:** 3 minutes 30 seconds
- 7.4.1.5** **Free Combination:** 4 minutes
- 7.4.1.6** There shall be no minimum time limit.
- 7.4.2** The size of the competition pool shall be 25x20 metres and minimum 2.5 metres deep.
- 7.4.3** Goggles may be worn.
- 7.5** **Appendix – Required Elements for Masters Technical Routines**
- 7.5.1** **General Requirements**
- Supplementary elements may be added.
- 7.5.1.1** Unless otherwise specified in the description of an element:
- 1) All figures or components thereof shall be executed according to the requirements described in this Appendix.
  - 2) All elements shall be executed high and controlled in uniform motion with each section clearly defined.
- 7.5.1.2** Time limits are as in Part Eight, Article 7.4.1



### 7.5.2 Solo Required Elements

Elements 1 to 5 should follow the order listed on the Elements Order Card. Element 6 may be performed at any time during the routine.

**FISHTAIL** – from a Front Layout Position, a Front Pike Position is assumed; one leg is lifted to a Fishtail Position, the second leg is lifted to a Vertical Position (ending is optional).

**SPLIT POSITION** – followed by a walkout front or walkout back.

**SPINNING 180°** – From a Bent Knee Position, a Spin 180° is executed as the legs are joined to a Vertical Position at the ankles followed by submergence.

**TRAVELLING BALLET LEG COMBINATION** – Beginning in a Back Layout Position a ballet leg alternate is executed with travel.

**BARRACUDA BENT KNEE** – From the Back Pike Position with the legs perpendicular and the toes just below the surface, a Thrust is executed as one leg is drawn along the inside of the other extended leg to assume a Bent Knee Vertical Position. A Vertical Descent is executed in a Bent Knee Vertical Position at the same tempo as the Thrust.

**TWO (2) FORMS OF PROPULSION** – Must include Egg Beater travelling sideways and/or forward (arms optional)

### 7.5.3 Duet and Mixed Duet Required Elements

Elements 1 – 5 should follow the order listed on the Elements Order Card. Elements 6 – 7 may be executed at any time during the routine **Routines for Duet 1 to 6 as above for Solo.**

**JOINED ACTION** – Where the swimmers are connected (touching) in some manner to perform one of the following:

- 1) A connected figure or a connected float or connected stroking
- 2) Action must be performed simultaneously. Minor action is permitted.

With the exception of the DECK WORK and ENTRY and as noted in the JOINED ACTION, all elements, required and supplementary, MUST be performed simultaneously and facing the same direction by both swimmers. Variation in propulsion and direction facing are permitted during pattern changes.

### 7.5.4 Team Required Elements

Elements 1 – 5 should follow the order listed on the Elements Order Card. Elements 6 – 9 may be executed at any time during the routine **Routines for Team 1 to 7 as above for Duet.**

**CADENCE ACTION** – Identical movements performed sequentially, one by one, by all team members. When more than one cadence action is performed, they must be consecutive and not separated by other optional or required elements. A second cadence action may begin before the first cadence action is completed by all team members but each team member must do the action of each cadence.

**PATTERNS** – must show one circle and straight line. Elements may be performed when in the circle or the straight-line patterns.

With the exception of the DECK WORK, ENTRY, CADENCE and as noted in the JOINED ACTION, all elements, required and supplementary, MUST be performed simultaneously and facing the same direction by all swimmers. Swimmers need not face the same direction in the circle pattern. Variation in propulsion and direction facing are permitted during pattern changes. Mirror actions are not permitted except in the description of the elements.

## 8 WORLD AQUATICS MASTERS CHAMPIONSHIPS

### 8.1 General

#### 8.1.1 Management Committee

For World Aquatics Masters Championships, the Management Committee shall consist of the Bureau Liaison, the Chairman and the Vice-Chairman of the Masters Committee and other members of the Bureau and Masters Committee present.

**8.1.2 Entry fees**

Entry Fees shall be decided upon by the country that is hosting the World Aquatics Masters Championships, but they shall be subject to approval by World Aquatics.

**8.1.3 Awards and Medals**

For World Aquatics Masters Championships, medals shall be awarded to competitors and teams placed first, second and third in each event and Age Group.

In Artistic Swimming the reserves will receive medals only if they actually swim in the technical and/or Free Routine.

Diplomas can be awarded to competitors and team members placed first to ten in each event and Age Group.

**8.1.4 Eligibility**

A participant can represent only one club in each sport.

**8.1.5 Entry**

Electronic Entries shall be used for registration and payment of fees to the World Aquatics Masters Championships via the World Aquatics General Management System (GMS), when available.

**8.1.5.1 Swimming**

Qualifying standards for World Aquatics Masters Championships will be considered by World Aquatics and the Organising Committee if deemed necessary.

At the World Aquatics Masters Championships it is not necessary to conduct all events mentioned in Part Eight, Article 3.2. However, each age division should include shorter Freestyle, Backstroke, Breaststroke and Butterfly events plus Individual Medley and Relays.

A swimmer can compete only once per relay event.

Events shall be pre-seeded with oldest age groups first, slowest heats swum first within each age group. Events 400 metres and over may be seeded from slowest to fastest regardless of age.

A swimmer may be entered for not more than five (5) individual events.

A swimmer entered for one club has to represent this club in all Swimming events at the Championships.

The composition of a relay team can be changed up to the deadline announced by the Organising Committee on the day prior to the relay event. The age of the substitute swimmer(s) cannot change the age group of the entered relay team. Substitute swimmer(s) must be registered for the Championships.

A swimmer must have reached Qualification Time (entry time) in a competition within 2 years period before the competition. If a swimmer clearly fails to achieve the Qualification Time at the current competition, he/she may be excluded from all upcoming individual events in the same competition.

**8.1.5.1.1 Competition and warm up safety procedures**

OC must ensure the following safety procedures are applied. It is incumbent on swimmers and officials to work together to comply with these procedures at all times..

General Warm-up:

- Swimmers must enter the pool feet first in a cautious manner, entering from a start of turn end only and from a standing or sitting position.
- Running on the pool deck is prohibited
- OC may designate the use of ONE-WAY Sprint lanes during the scheduled warm-up time. Any such lane usage must be communicated to the competitors with visible deck signage.
- Diving starts shall be permitted ONLY in designated sprint lanes. Only one-way swimming from the start end of the sprint lane is permitted.
- Pools with backstroke ledges available may offer a designated lane for backstroke starts, at the meet management's discretion.



- Notices or barriers must be placed on starting blocks to indicate no diving during warm-up
- Training aids (such as pull-buoys, kick boards, fins, hand paddles, cords or other training aids) are NOT allowed
- Jewelry and watches except for rings, stud earrings and medical alert identifiers will not be permitted
- A Lane needs to be reserved for Swimmers over the Age of 65
- At the discretion of the OC and based on available space, the meet management may allow noncompetitors for that day to use the training facilities.
- Only competitors will be allowed on the FOP and in the training pools located in the swimming venue of the event

### **8.1.5.2 Open Water Swimming**

A Masters Open Water Swimming event may be included in World Aquatics Masters Championships.

The Organising Committee shall follow the World Aquatics Open Water Safety Regulations.

Swimmers shall be seeded according to age groups from the youngest to the oldest. Swimmers may be selected irrespective of sex. The slowest entered swimmers of each age group may comprise and be seeded in special heat(s). By recommendation of the World Aquatics Masters Commission and/or nominated Sport Manager-Chief Referee or Safety Officer this order may be changed.

If the number of entries is more than 1'000 the competition may be swum in two or more days.

Race organisers, in consultation with the referee and subject to advice from the World Aquatics Masters Committee, are to designate in advance the cut off time. For the World Aquatics Masters Championships a cut off time of 30 minutes per kilometre shall apply.

### **8.1.5.3 Diving**

The programme of the World Aquatics Masters Championships shall include 1 metre Springboard Men and Women, 3 metre Springboard Men and Women, Platform Men and Women, Synchronized 3 metre Women, Men, Mixed Team, Synchronized Diving Platform Women, Men, and Mixed Team.

The meet director may choose to run the events concurrently depending on the number of entries.

Diving sheets shall be delivered to the diving secretary 24 hours prior to the event. Late sheets and changed to an existing sheet will be fined USD 10,- per sheet between 24 hours and 3 hours prior to the event. 3 hours is the deadline. No changes or dive sheets can be accepted after the deadline of 3 hours.

At the World Aquatics Masters Championships at least 5 judges and in Synchronised Diving at least 7 judges shall officiate.

All divers shall perform a full series of dives in that age group and there shall be no preliminary of final contests.

A diver can compete in only one team per Synchronised Diving event.

### **8.1.5.4 Water Polo**

#### **8.1.5.4.1 Composition of Teams**

A player may not represent more than one team at the World Aquatics Masters Championships.

The final composition of the team with numbering of the caps shall be announced latest at the Technical Meeting prior to the Championships. All players must be registered as a player according to the entry specifications. No additional members can be added.

A Water Polo team can consist of up to fifteen (15) players registered with the same club.



#### 8.1.5.4.2 Composition of groups for the preliminary round

Before the draw for the World Aquatics Masters Championships the following exceptions of composing the groups for the preliminary rounds shall be approved.

With less than three teams entered in one Age Group this Age Group shall be combined with the next younger Age Group or alternatively combined to the next older Age Group. The concerned teams shall be consulted for approval and given the possibility to cancel their participation with return of paid fees.

An Age Group with three teams entered can be combined with the next younger or older Age Group if these groups do not have more than four teams entered and with the approval of all concerned teams. The playing schedule and the plan for rankings shall be decided by the World Aquatics Masters Commission.

For the Women tournament the composition of groups is depending on the number of entries in each Age Group. The World Aquatics Masters Commission can combine the groups including teams of more than two Age Groups. The approval by the entered teams shall be asked. A playing schedule and the plan for rankings for each Age Group shall be decided by the World Aquatics Masters Commission.

#### 8.1.5.4.3 Schedule for Age Groups

##### 1. Schedule for three (3) teams

The three teams shall play a double round-robin. If there is a tie in points between first and second placed teams they shall play a decisive game on Day 7.

Day 1	Day 2	Day 3	Day 4	Day 5	Day 6	Day 7
1. A1 - A3	2. A2 - A3	3. A1 - A2	4. A2 - A3	5. A1 - A3	6. A1 - A2	7. Final

For the 60+ and over age groups, the schedule for three (3) teams will only play a double round robin play. No Final on Day 7.

##### 2. Schedule for four (4) teams

Day 1	Day 2	Day 3	Day 4	Day 5	Day 6	Rankings
1. A1 - A3	3. A1 - A4	5. A3 - A4	7. 1A - 4A	(rest day)	9. L7 - L8	<b>3rd/4th</b>
2. A2 - A4	4. A2 - A3	6. A1 - A2	8. 2A - 3A		10. W7 - W8	<b>1st/2nd</b>

The four teams shall play a single round-robin as a preliminary round from Day 1 to Day 3. Semi-finals are played on Day 4, between the 1<sup>st</sup> and 4<sup>th</sup> and the 2<sup>nd</sup> and 3<sup>rd</sup> placed teams from the preliminary round. Day 5 will be a rest day. Finals shall be played on Day 6.

For the 60+ and over age group, the schedule for four (4) teams will play a double round-robin.

Day 1	Day 2	Day 3	Day 4	Day 5	Day 6	Day 7
<b>1</b> <b>A1-A3</b>	<b>3</b> <b>A1-A4</b>	<b>5</b> <b>A3-A4</b>	<b>7</b> <b>A1-A3</b>	<b>9</b> <b>A1-A4</b>	<b>11</b> <b>A3-A4</b>	<b>No Final</b>
<b>2</b> <b>A2-A4</b>	<b>4</b> <b>A2-A3</b>	<b>6</b> <b>A1-A2</b>	<b>8</b> <b>A2-A4</b>	<b>10</b> <b>A2-A3</b>	<b>12</b> <b>A1-A2</b>	

##### 3. Schedule for five (5) teams

The five teams shall play a single round-robin as a preliminary round on Day 1 to Day 5. The 5<sup>th</sup> placed team from the preliminary round will be ranked fifth. Semi-finals are played on Day 6 between the 1<sup>st</sup> and 4<sup>th</sup> and the 2<sup>nd</sup> and 3<sup>rd</sup> placed teams from the preliminary round. Finals shall be played on Day 7.





Day 1	Day 2	Day 3	Day 4	Day 5	Day 6	Day 7	Rankings
1. A1 - A5	3. A4 - A5	5. A3 - A4	7. A2 - A3	9. A3 - A5	11. 1A - 4A	13. L11 - L12	<b>3rd/4th</b>
2. A2 - A4	4. A1 - A3	6. A2 - A5	8. A1 - A4	10. A1 - A2	12. 2A - 3A	14. W11-W12	<b>1st/2nd</b>

#### 4. Schedule for six (6) teams

The six teams shall play a single round-robin as a preliminary round on Day 1 to Day 5. Semi-finals are played on Day 6 between the 1<sup>st</sup> and 4<sup>th</sup> and 2<sup>nd</sup> and 3<sup>rd</sup> placed teams. Teams placed 5<sup>th</sup> and 6<sup>th</sup> will play for rankings 5 and 6. Finals shall be played on Day 7.

Day 1	Day 2	Day 3	Day 4	Day 5	Day 6	Day 7	Rankings
1. A1-A6	4. A3-A6	7. A4-A5	10. A5-A6	13. A4-A6	16. 5A-6A		<b>5th/6th</b>
2. A3-A4	5. A2-A4	8. A2-A6	11. A1-A4	14. A3-A5	17. 1A-4A	19. L17-L18	<b>3rd/4th</b>
3. A2-A5	6. A1-A5	9. A1-A3	12. A2-A3	15. A1-A2	18. 2A-3A	20. W17-W18	<b>1st/2nd</b>

#### 5. Schedule for seven (7) teams

The seven teams shall play a single round-robin from Day 1 to Day 7. Final rankings shall be based on points earned during the round-robin.

Day 1	Day 2	Day 3	Day 4	Day 5	Day 6	Day 7
1. A1-A5	4. A2-A3	7. A6-A7	10. A1-A3	13. A2-A7	16. A3-A5	19. A5-A6
2. A2-A4	5. A4-A7	8. A1-A4	11. A4-A6	14. A4-A5	17. A1-A7	20. A3-A4
3. A3-A7	6. A1-A6	9. A2-A5	12. A5-A7	15. A3-A6	18. A2-A6	21. A1-A2



### 6. Schedule for (8) teams

The eight teams shall play on Day 1 to Day 3 a preliminary round-robin in two Groups, A and B, with four teams in each group. The Quarter finals shall be played on Day 4 as cross-over games. The semi- finals shall be played on Day 5 between the winners of each Quarter final and for lower rankings between the losers. On Day 6 the rankings for rankings 5 to 8 will be played. The finals shall be played on Day 7.

Day 1	Day 2	Day 3	Day 4	Day 5	Day 6	Day 7	Rankings
1. A2 - A3	5. B1 - B3	9. A3 - A4	13. 2A - 3B	17. L13 - L16	21. L17 - L18		7 <sup>th</sup> /8 <sup>th</sup>
2. A1 - A4	6. B2 - B4	10. A2 - A1	14. 2B - 3A	18. L14 - L15	22. W17 - W18		5 <sup>th</sup> /6 <sup>th</sup>
3. B2 - B3	7. A2 - A4	11. B3 - B4	15. 1A - 4B	19. W13 - W16		23. L19 - L20	3 <sup>rd</sup> /4 <sup>th</sup>
4. B1 - B4	8. A1 - A3	12. B2 - B1	16. 1B - 4A	20. W14 - W15		24. W19 - W20	1 <sup>st</sup> /2 <sup>nd</sup>

### 7. Schedule for nine (9) teams

The nine teams shall play on Day 1 to Day 5 a preliminary round-robin in two Groups, A and B, with four teams in Group A and with five team in Group B.

The semi- finals shall be played on Day 6 between the two best placed teams from each preliminary group and the teams placed 3<sup>rd</sup> and 4<sup>th</sup>. The fifth team in Group B will be ranked for the 9<sup>th</sup> place.

The final rankings from 1<sup>st</sup> to 8<sup>th</sup> shall be played on Day 7.

Day 1	Day 2	Day 3	Day 4	Day 5	Day 6	Day 7	Rankings
1. A1 - A4	5. B4 - B5	7. A1 - A3	11. B2 - B3	13. A3 - A4	17. 3A - 4B	21. L17 - L18	7 <sup>th</sup> /8 <sup>th</sup>
2. A2 - A3	6. B1 - B3	8. A2 - A4	12. B1 - B4	14. A1 - A2	18. 3B - 4A	22. W17 - W18	5 <sup>th</sup> /6 <sup>th</sup>
3. B1 - B5		9. B2 - B5		15. B3 - B5	19. 1B - 2A	23. L19 - L20	3 <sup>rd</sup> /4 <sup>th</sup>
4. B2 - B4		10. B3 - B4		16. B1 - B2	20. 1A - 2B	24. W19 - W20	1 <sup>st</sup> /2 <sup>nd</sup>

### 8. Schedule for ten (10) teams

The ten teams shall play on Day 1 to Day 5 a preliminary round-robin in two Groups, A and B, with five teams team in both groups.

The semi- finals shall be played on Day 6 between the two best placed teams from each preliminary group and the teams placed 3<sup>rd</sup> and 4<sup>th</sup>. The teams placed 5<sup>th</sup> shall play for the final rankings 9<sup>th</sup> and 10<sup>th</sup>.

The final rankings from 1<sup>st</sup> to 8<sup>th</sup> shall be played on Day 7.

Day 1	Day 2	Day 3	Day 4	Day 5	Day 6	Day 7	Rankings
1. A1 - A5	5. B4 - B5	9. A3 - A4	13. A2 - A3	17. B1 - B2	21. 5A - 5B		9 <sup>th</sup> /10 <sup>th</sup>
2. A2 - A4	6. B1 - B3	10. A2 - A5	14. A1 - A4	18. B3 - B5	22. 4A - 3B	26. L22 - L23	7 <sup>th</sup> /8 <sup>th</sup>
3. B1 - B5	7. A4 - A5	11. B3 - B4	15. B2 - B3	19. A3 - A5	23. 3A - 4B	27. W22 - W23	5 <sup>th</sup> /6 <sup>th</sup>
4. B2 - B4	8. A1 - A3	12. B2 - B5	16. B1 - B4	20. A1 - A2	24. 2A - 1B	28. L24 - L25	3 <sup>rd</sup> /4 <sup>th</sup>
					25. 1A - 2B	29. W24 - W25	1 <sup>st</sup> /2 <sup>nd</sup>

**9. Schedule for eleven (11) teams**

The eleven teams shall play on Day 1 to Day 5 a preliminary round-robin in two Groups, A and B, with five teams in Group A and six teams in Group B. The semi-finals shall be played on Day 6 between the two best placed teams from each preliminary group the teams placed 3<sup>rd</sup> and 4<sup>th</sup>. The teams placed 5<sup>th</sup> shall play for rankings 9<sup>th</sup> and 10<sup>th</sup>. The team placed 6<sup>th</sup> in Group B will be ranked 11<sup>th</sup>. The final ranking rankings from 1<sup>st</sup> to 8<sup>th</sup> shall be played on Day 7.

Day 1	Day 2	Day 3	Day 4	Day 5	Day 6	Day 7	Rankings
1. A3 - A4	6. B3 - B5	11. A4 - A5	16. B5 - B6	21. A2 - A4	26. 5A - 5B		9 <sup>th</sup> /10 <sup>th</sup>
2. A2 - A5	7. B4 - B6	12. A1 - A3	17. B1 - B4	22. A1 - A5	27. 3A - 4B	31. L27 - L28	7 <sup>th</sup> /8 <sup>th</sup>
3. B1 - B6	8. B1 - B2	13. B2 - B6	18. B2 - B3	23. B3 - B6	28. 3B - 4A	32. W27 - W28	5 <sup>th</sup> /6 <sup>th</sup>
4. B3 - B4	9. A3 - A5	14. B4 - B5	19. A1 - A4	24. B2 - B4	29. 1A - 2B	33. L29 - L30	3 <sup>rd</sup> /4 <sup>th</sup>
5. B2 - B5	10. A1 - A2	15. B1 - B3	20. A2 - A3	25. B1 - B5	30. 1B - 2A	34. W29 - W30	1 <sup>st</sup> /2 <sup>nd</sup>

**10. Schedule for twelve (12) teams**

The twelve teams shall play on Day 1 to Day 5 a preliminary round-robin in two Groups, A and B, with six teams in each group. Semi-finals shall be played on Day 6 between the two best placed teams from each preliminary group and the teams placed 3<sup>rd</sup> and 4<sup>th</sup> and the teams placed 5<sup>th</sup> and 6<sup>th</sup>. Finals for rankings 1<sup>st</sup> to 12<sup>th</sup> shall be played on Day 7.

Day 1	Day 2	Day 3	Day 4	Day 5	Day 6	Day 7	Rankings
1. A1 - A6	7. B4 - B6	13. A4 - A5	19. B5 - B6	25. A3 - A6	31. 6A - 5B	37. L31 - L32	11 <sup>th</sup> /12 <sup>th</sup>
2. A3 - A4	8. B3 - B5	14. A2 - A6	20. B1 - B4	26. A2 - A4	32. 5A - 6B	38. W31 - W32	9 <sup>th</sup> /10 <sup>th</sup>
3. A2 - A5	9. B1 - B2	15. A1 - A3	21. B2 - B3	27. A1 - A5	33. 4A - 3B	39. L33 - L34	7 <sup>th</sup> /8 <sup>th</sup>
4. B1 - B6	10. A4 - A6	16. B4 - B5	22. A5 - A6	28. B3 - B6	34. 3A - 4B	40. W33 - W34	5 <sup>th</sup> /6 <sup>th</sup>
5. B3 - B4	11. A3 - A5	17. B2 - B6	23. A1 - A4	29. B2 - B4	35. 2A - 1B	41. L35 - L36	3 <sup>rd</sup> /4 <sup>th</sup>
6. B2 - B5	12. A1 - A2	18. B1 - B3	24. A2 - A3	30. B1 - B5	36. 1A - 2B	42. W35 - W36	1 <sup>st</sup> /2 <sup>nd</sup>



### 11. Schedule for thirteen (13) teams

The thirteen teams shall play on Day 1 to Day 3 a preliminary round-robin in four Groups, with three teams in Groups A, B and C and four teams in group D.

On Day 4 the teams placed 2<sup>nd</sup> and 3<sup>rd</sup> in each preliminary group shall play a second preliminary round in a cross group format. The first placed teams will have a rest day.

The fourth placed team in Group D will be ranked 13<sup>th</sup>.

Semi-finals and matches for rankings 9<sup>th</sup> to 12<sup>th</sup> shall be played on Day 6.

Finals for rankings 1<sup>st</sup> to 8<sup>th</sup> shall be played on Day 7.

Day 1	Day 2	Day 3	Day 4	Day 5	Day 6	Day 7	Rankings
1. A1 - A3	6. B1 - B2	11. C2 - C3	16. 2A - 3B	20. L16 - L18	26. L20 - L21		11 <sup>th</sup> /12 <sup>th</sup>
2. B1 - B3	7. C1 - C2	12. D1 - D4	17. 3A - 2B	21. L17 - L19	27. W20 - W2		9 <sup>th</sup> /10 <sup>th</sup>
3. C1 - C3	8. D3 - D4	13. D2 - D3	18. 2C - 3D	22. 1A - W18	28. L22 - L23	32. L28 - L29	7 <sup>th</sup> /8 <sup>th</sup>
4. D1 - D3	9. D1 - D2	14. A2 - A3	19. 3C - 2D	23. 1B - W19	29. L24 - L25	33. W28 - W29	5 <sup>th</sup> /6 <sup>th</sup>
5. D2 - D4	10. A1 - A2	15. B2 - B3		24. 1C - W16	30. W22 - W23	34. L30 - L31	3 <sup>rd</sup> /4 <sup>th</sup>
				25. 1D - W17	31. W24 - W25	35. W30 - W31	1 <sup>st</sup> /2 <sup>nd</sup>

### 12. Schedule for fourteen (14) teams

The fourteen teams shall play Day 1 to Day 3 a preliminary round-robin in four groups with three teams in Group A and B and with four teams in Group C and D.

On Day 4 the teams placed 2<sup>nd</sup> and 3<sup>rd</sup> shall play a second preliminary round in a cross group format. The first placed teams will have a rest day.

The fourth placed teams from Groups C and D will play a decisive match for places 13<sup>th</sup> and 14<sup>th</sup>.

Semi-finals and matches for rankings 9<sup>th</sup> to 12<sup>th</sup> shall be played on Day 6.

Finals for rankings 1<sup>st</sup> to 8<sup>th</sup> shall be played Day 7.

Day 1	Day 2	Day 3	Day 4	Day 5	Day 6	Day 7	Rankings
1. A1 - 3	7. B1 - B2	13. C1 - C4	19. 4C - 4D				13 <sup>th</sup> /14 <sup>th</sup>
2. B1 - B3	8. C4 - C3	14. C2 - C3	20. 2A - B	24. L20 - L22	30. L24 - L25		11 <sup>th</sup> /12 <sup>th</sup>
3. C1 - C3	9. C1 - C2	15. D1 - D4	21. 3A - 2B	25. L21 - L23	31. W24 - W25		9 <sup>th</sup> /10 <sup>th</sup>
4. C2 - C4	10. D4 - D3	16. D2 - D3	22. 2C - 3D	26. 1A - W22	32. L26 - L27	34. L32 - L33	7 <sup>th</sup> /8 <sup>th</sup>
5. D1 - D3	11. D1 - D2	17. A2 - A3	23. 3C - 2D	27. 1B - W23	33. L28 - L29	35. W32 - W33	5 <sup>th</sup> /6 <sup>th</sup>
6. D2 - D4	12. A1 - A2	18. B2 - B3		28. 1C - W20	34. W28 - W29	36. L34 - L35	3 <sup>rd</sup> /4 <sup>th</sup>
				29. 1D - W21	35. W26 - W27	37. W34 - W35	1 <sup>st</sup> /2 <sup>nd</sup>

**13. Schedule for fifteen (15) teams**

The fifteen teams shall play Day 1 to Day 3 a preliminary round-robin in four groups with three teams in Group A and four teams in Groups B, C and D. On Day 4 the teams placed 2<sup>nd</sup> and 3<sup>rd</sup> shall play a second preliminary round in a cross format. The first placed teams will have a rest day on Day 4. From Day 4 to Day 6 the three fourth placed teams shall play a round-robin for places 13<sup>th</sup> to 15<sup>th</sup>. Semi-finals shall be played on Day 6 and the Finals on Day 7.

Day 1	Day 2	Day 3	Day 4	Day 5	Day 6	Day 7	Rankings
1. A1 - A3	8. B4 - B3	15. C1 - C4	22. 4B - 4D	27. 4C - 4D	34. 4B - 4C		13 <sup>th</sup> /14 <sup>th</sup> /15 <sup>th</sup>
2. B1 - B3	9. B1 - B2	16. C2 - C3	23. 2A - 3B	28. L23 - L25	35. L28 - L29		11 <sup>th</sup> /12 <sup>th</sup>
3. B2 - B4	10. C4 - C3	17. D1 - D4	24. 3A - 2B	29. L24 - L26	36. W28 - W29		9 <sup>th</sup> /10 <sup>th</sup>
4. C1 - C3	11. C1 - C2	18. D2 - D3	25. 2C - 3D	30. 1A - W25	37. L30 - L31	41. L37 - L38	7 <sup>th</sup> /8 <sup>th</sup>
5. C2 - C4	12. D4 - D3	19. A2 - A3	26. 3C - 2D	31. 1B - W26	38. L32 - L33	42. W37 - W38	5 <sup>th</sup> /6 <sup>th</sup>
6. D1 - D3	13. D1 - D2	20. B1 - B4		32. 1C - W23	39. W30 - W31	43. L39 - L40	3 <sup>rd</sup> /4 <sup>th</sup>
7. D2 - D4	14. A1 - A2	21. B2 - B3		33. 1D - W24	40. W32 - W33	44. W39 - W40	1 <sup>st</sup> /2 <sup>nd</sup>

**14. Schedule for sixteen (16) teams**

The sixteen teams shall play on Day 1 to Day 3 a preliminary round-robin in four groups, Group A, B, C and D, with four teams in each group. On Day 4 the teams placed 2<sup>nd</sup> to 4<sup>th</sup> shall play second preliminary round, where the second and third placed teams in each group in a cross group format. The fourth placed teams in each group form a new group of four teams and they shall play for places 13<sup>th</sup> to 16<sup>th</sup>. The first placed teams will have a rest day on Day 4. The Quarter Final Round shall be played on Day 6. The finals for places 1<sup>st</sup> to 8<sup>th</sup> shall be played in Day 7.

Day 1	Day 2	Day 3	Day 4	Day 5	Day 6	Day 7	Rankings
1. A1 - A3	9. B4 - B3	17. C1 - C4	25. 4A - 4B	31. L25 - L26			15 <sup>th</sup> /16 <sup>th</sup>
2. A2 - A4	10. B1 - B2	18. C2 - C3	26. 4C - 4D	32. W25 - W26			13 <sup>th</sup> /14 <sup>th</sup>
3. B1 - B3	11. C4 - C3	19. D1 - D4	27. 2A - 3B	33. L27 - L29	39. L33 - L34		11 <sup>th</sup> /12 <sup>th</sup>
4. B2 - B4	12. C1 - C2	20. D2 - D3	28. 3A - 2B	34. L28 - L30	40. W33 - W34		9 <sup>th</sup> /10 <sup>th</sup>
5. C1 - C3	13. D4 - D3	21. A1 - A4	29. 2C - 3D	35. 1A - W29	41. L35 - L36	45. L41 - L42	7 <sup>th</sup> /8 <sup>th</sup>
6. C2 - C4	14. D1 - D2	22. A2 - A3	30. 3C - 2D	36. 1B - W30	42. L37 - L38	46. W41 - W42	5 <sup>th</sup> /6 <sup>th</sup>
7. D1 - D3	15. A4 - A3	23. B1 - B4		37. 1C - W27	43. W35 - W36	47. L43 - L44	3 <sup>rd</sup> /4 <sup>th</sup>
8. D2 - D4	16. A1 - A2	24. B2 - B3		38. 1D - W28	44. W37 - W38	48. W43 - W44	1 <sup>st</sup> /2 <sup>nd</sup>

**15. Schedule for seventeen (17) teams**

The seventeen teams shall play on Day 1 to Day 4 a preliminary round- robin in four Groups, A, B, C and D, with four teams in Group A, B and C, and five teams in Group D and with the teams from D having for one day two matches. The Quarter Finals shall be played on Day 5 with the first and second placed teams and the third and fourth placed teams shall play each other in a cross group format. The fifth placed team in Group D will be ranked 17<sup>th</sup>. Semi-finals shall be played on Day 6 and the Finals on Day 7.

Day 1	Day 2	Day 3	Day 4	Day 5	Day 6	Day 7	Rankings
1. D3 - D5	10. C1 - C3	17. D1 - D4	24. A2 - A4	29. 4A - 3D	37. L29 - L30	45. L37 - L38	15 <sup>th</sup> /16 <sup>th</sup>
2. D1 - D2	11. D4 - D5	18. D2 - D3	25. B1 - B3	30. 3A - 4D	38. L31 - L32	46. W37 - W38	13 <sup>th</sup> /14 <sup>th</sup>
3. C1 - C2	12. D1 - D3	19. A1 - A3	26. C3 - C4	31. 4B - 3C	39. W29 - W30	47. L39 - L40	11 <sup>th</sup> /12 <sup>th</sup>
4. B3 - B4	13. A2 - A3	20. B1 - B4	27. D3 - D4	32. 3B - 4C	40. W31 - 32	48. W39 - W40	9 <sup>th</sup> /10 <sup>th</sup>
5. B1 - B2	14. A1 - A4	21. B2 - B3	28. D2 - D5	33. 2A - 1D	41. L33 - L34	49. L41 - L42	7 <sup>th</sup> /8 <sup>th</sup>
6. A1 - A2	15. B2 - B4	22. C1 - C4		34. 1A - 2D	42. L35 - L36	50. W41 - W42	5 <sup>th</sup> /6 <sup>th</sup>
7. A3 - A4	16. C2 - C4	23. C2 - C3		35. 2B - 1C	43. W33 - W34	51. L43 - L44	3 <sup>rd</sup> /4 <sup>th</sup>
8. D1 - D5				36. 1B - 2C	44. W35 - W36	52. W43 - W44	1 <sup>st</sup> /2 <sup>nd</sup>
9. D2 - D4							

**16. Schedule for eighteen (18) teams**

The eighteen teams shall play on Day 1 to Day 4 a preliminary round- robin in four Groups, A, B, C and D, with four teams in Group A and B, and five teams in Group C and D and with teams from C and D having for one day two matches.

The Quarter Finals shall be played on Day 5 with the first and second placed teams and the third and fourth placed teams shall play each other in a cross group format. The fifth placed teams shall play final match for places 17<sup>th</sup> and 18<sup>th</sup>.

Semi-finals shall be played on Day 6 and the Finals on Day 7.

Day 1	Day 2	Day 3	Day 4	Day 5	Day 6	Day 7	Rankings
1. B3 - B4	9. C4 - C5	18. D1 - D4	27. C2 - C5	33. 4A - 3D	41. 5C - 5D		17 <sup>th</sup> /18 <sup>th</sup>
2. B1 - B2	10. C1 - C3	19. D2 - D3	28. A2 - A4	34. 3A - 4D	42. L33 - L34	50. L42 - L43	15 <sup>th</sup> /16 <sup>th</sup>
3. C3 - C5	11. D4 - D5	20. A1 - A3	29. B1 - B3	35. 4B - 3C	43. L35 - L36	51. W42 - W43	13 <sup>th</sup> /14 <sup>th</sup>
4. C1 - C2	12. D1 - D3	21. B1 - B4	30. C3 - C4	36. 3B - 4C	44. W33 - W34	52. L44 - L45	11 <sup>th</sup> /12 <sup>th</sup>
5. D3 - D5	13. A2 - A3	22. B2 - B3	31. D3 - D4	37. 2A - 1D	45. W35 - W36	53. W44 - W45	9 <sup>th</sup> /10 <sup>th</sup>
6. D1 - D2	14. A1 - A4	23. C1 - C4	32. D2 - D5	38. 1A - 2D	46. L37 - L38	54. L46 - L47	7 <sup>th</sup> /8 <sup>th</sup>
7. A1 - A2	15. B2 - B4	24. C2 - C3		39. 2B - 1C	47. L39 - L40	55. W46 - W47	5 <sup>th</sup> /6 <sup>th</sup>
8. A3 - A4	16. C1 - C5	25. D1 - D5		40. 1B - 2C	48. W37 - W38	56. L48 - L49	3 <sup>rd</sup> /4 <sup>th</sup>
	17. C2 - C4	26. D2 - D4			49. W39 - W40	57. W48 - W49	1 <sup>st</sup> /2 <sup>nd</sup>

**17. Schedule for nineteen (19) teams**

The nineteen teams shall play on Day 1 to Day 4 a preliminary round- robin in four Groups, A, B, C and D, with four teams in Group A and five teams in Groups B, C and D and with teams from B, C and D having for one day two matches.

The Quarter Finals shall be played on Day 5 with the 1<sup>st</sup> and 2<sup>nd</sup> placed teams and the 3<sup>rd</sup> and 4<sup>th</sup> placed teams shall play each other in a cross group format. The 5<sup>th</sup> placed teams shall play a round-robin for rankings 17<sup>th</sup> to 19<sup>th</sup>.

Semi-finals shall be played on Day 6 and the Finals on Day 7.

Day 1	Day 2	Day 3	Day 4	Day 5	Day 6	Day 7	Rankings
1. B3 - B5	11. C4 - C5	20. D1 - D4	29. B2 - B5	37. 5B - 5C	46. 5B - 5D	55. 5C - 5D	<b>17<sup>th</sup>/18<sup>th</sup>/19<sup>th</sup></b>
2. B1 - B2	12. C1 - C3	21. D2 - D3	30. C2 - C5	38. 4A - 3D	47. L38 - L39	56. L47 - L48	<b>15<sup>th</sup>/16<sup>th</sup></b>
3. C3 - C5	13. D4 - D5	22. A1 - A3	31. D2 - D5	39. 3A - 4D	48. L40 - L41	57. W47 - W48	<b>13<sup>th</sup>/14<sup>th</sup></b>
4. C1 - C2	14. D1 - D3	23. B1 - B4	32. A1 - A4	40. 4B - 3C	49. W38 - W39	58. L49 - L50	<b>11<sup>th</sup>/12<sup>th</sup></b>
5. D3 - D5	15. A2 - A4	24. B2 - B3	33. A2 - A3	41. 3B - 4C	50. W40 - W41	59. W49 - W50	<b>9<sup>th</sup>/10<sup>th</sup></b>
6. D1 - D2	16. B4 - B5	25. C1 - C4	34. B3 - B4	42. 2A - 1D	51. L42 - L43	60. L51 - L52	<b>7<sup>th</sup>/8<sup>th</sup></b>
7. A3 - A4	17. B1 - B3	26. C2 - C3	35. C3 - C4	43. 1A - 2D	52. L44 - L45	61. W51 - W52	<b>5<sup>th</sup>/6<sup>th</sup></b>
8. A1 - A2	18. C1 - C5	27. D1 - D5	36. D3 - D4	44. 2B - 1C	53. W42 - W43	62. L53 - L54	<b>3<sup>rd</sup>/4<sup>th</sup></b>
9. B1 - B5	19. C2 - C4	28. D2 - D4		45. 1B - 2C	54. W44 - W45	63. W53 - W54	<b>1<sup>st</sup>/2<sup>nd</sup></b>
10. B2 - B4							

**18. Schedule for twenty (20) teams**

The twenty teams shall play on Day 1 to Day 4 a preliminary round-robin in four Groups, A, B, C and D, with five teams in each group and with teams from each group having for one day two matches.

The Quarter Finals shall be played on Day 5 with the 1<sup>st</sup> and 2<sup>nd</sup> placed teams and the 3<sup>rd</sup> and 4<sup>th</sup> placed teams from each group.

The 5<sup>th</sup> placed teams shall play each other in a cross group format.

Semi-finals shall be played on Day 6 and the finals on Day 7.



Day 1	Day 2	Day 3	Day 4	Day 5	Day 6	Day 7	Rankings
1. A3-A4	11. B3-B5	21. C4-C5	31. D1-D4	41. 5A-5D	51. L41-L42		<b>19<sup>th</sup>/20<sup>th</sup></b>
2. A2-A5	12. B1-B2	22. C1-C3	32. D2-D3	42. 5B-5C	52. W41-W42		<b>17<sup>th</sup>/18<sup>th</sup></b>
3. B3-B4	13. C3-C5	23. D4-D5	33. A1-A4	43. 4A-3D	53. L43-L44	61. L53-L54	<b>15<sup>th</sup>/16<sup>th</sup></b>
4. B2-B5	14. C1-C2	24. D1-D3	34. A2-A3	44. 3A-4D	54. L45-L46	62. W53-W54	<b>13<sup>th</sup>/14<sup>th</sup></b>
5. C3-C4	15. D3-D5	25. A4-A5	35. B1-B4	45. 4B-3C	55. W43-W44	63. L55-L56	<b>11<sup>th</sup>/12<sup>th</sup></b>
6. C2-C5	16. D1-D2	26. A1-A3	36. B2-B3	46. 3B-4C	56. W45-W46	64. W55-W56	<b>9<sup>th</sup>/10<sup>th</sup></b>
7. D3-D4	17. A3-A5	27. B4-B5	37. C1-C4	47. 2A-1D	57. L47-L48	65. L57-L58	<b>7<sup>th</sup>/8<sup>th</sup></b>
8. D2-D5	18. A1-A2	28. B1-B3	38. C2-C3	48. 1A-2D	58. L49-L50	66. W57-W58	<b>5<sup>th</sup>/6<sup>th</sup></b>
9. A1-A5	19. B1-B5	29. C1-C5	39. D1-D5	49. 2B-1C	59. W47-W48	67. L59-L60	<b>3<sup>rd</sup>/4<sup>th</sup></b>
10. A2-A4	20. B2-B4	30. C2-C4	40. D2-D4	50. 1B-2C	60. W49-W50	68. W59-W60	<b>1<sup>st</sup>/2<sup>nd</sup></b>

#### 8.1.5.4.4 Draw

The draw for the World Aquatics Masters Championships shall be made at least one month prior to start of the Water Polo competition. The seeding for the draw for the preliminary rounds shall be based on the placing at the previous World Aquatics Masters Championships as follows:

With two groups in the age group:

First line, the best and second best placed of the entered teams from the previous Championships,

Second line, two of the next best placed of the entered teams from the previous Championships,

The rest of the entered teams shall be placed in groups by a random draw.

With four groups in the age group:

First line, four of the best placed of the entered teams from the previous Championships,

The rest of the entered teams shall be placed in groups by a random draw.

Teams from the same country should not be drawn in the same group, if possible

The World Aquatics Masters Commission can decide, if needed, on additional criteria as base for the draw.

#### 8.1.5.5 Artistic Swimming

In World Aquatics Masters Championships a club may enter in Solo, Solo Tech Duet, Mixed Duet, Team and Free Combination in each age group.

A competitor can take part in only one Duet, Mixed Duet, Team and one Free Combination.

A female competitor can take part in both Duet and Mixed Duet.

Changes in names of competitors for a routine must be received by the Chief Recorder at least 14 days prior to the first event of the Artistic Swimming competition. The new competitor must have already registered for the competition with the organising committee.

The reserves listed in a routine must be of an age that any combination of the listed competitors would result in swimming in the same age group.

Any changes in reserves must be handed to the Chief Recorder in writing at least two hours prior to the listed start time for the age group routine. Changes after this can only be made in the case of sudden illness of or an accident to a competitor and if the reserve is ready to compete without delaying the competition.





A competitor may be listed as a reserve on more than one routine in an age group event. However, once a competitor swims in one routine, that competitor is ineligible to swim in another routine in the same age group event.

Failure to notify the Chief Recorder of substitution and/or scratches shall result in disqualification of the routine.

#### 8.1.5.5.1 Order of Appearance

For the World Aquatics Masters Championships, a computer draw for the Technical Routines shall be done by the Chief Recorder at least 24 hours before the Technical Meeting.

The order of the draw shall be Team, Free Combination, Duet and Solo.

When a competitor(s) draws start number one (1) in a Technical Routine, they will be exempted from drawing start number one (1) in another Technical Routine in the same Age Group, if possible.

Swimming number one (1) in a Technical Routine does not make a routine exempt from swimming number one (1) in the Free Routine in the same event.

The order of appearance for the Free Routines in each age group shall be determined by the results of the Technical Routines for that age group event and shall be swum in groups of 6 competitors.

If the number of competitors is not divisible by 6, the smallest group shall start first.

If there are fewer than 12 entries in an age group event, the draw will be in two equal groups, the smallest group start first.

If there is a tie in the placement in an age group event which overlaps two groups, those competitors shall form a group of their own and swim between the original groups.

For each age group event, the lowest scoring competitors in the Technical Routine will swim in the first group and the highest scoring competitors will swim in the last group.

Within each age group in each event, the highest scoring competitor in the Technical Routine for that age group and event shall draw first, with the next competitors drawing in order of Technical Routine placement. In the case of ties, the order of draw shall be based on the Technical Routine start number, with the lowest start number drawing first.





#### 8.1.5.5.2 Judging and Scoring

At the World Aquatics Masters Championships at least four (4) judges shall officiate in three panels.

#### 8.1.5.5.3 For the World Aquatics Masters Championships the Degree of Difficulty for Required Elements shall be:

##### ELEMENT #1- 1.6

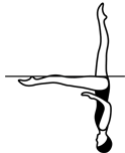

FISHTAIL – from a Front Layout Position, a Front Pike Position is assumed; one leg is lifted to a Fishtail Position, the second leg is lifted to a Vertical Position (ending is optional).

				<b>Total</b>
<b>NVT=</b>	6.0	14.5	20.5	<b>41</b>
<b>PV=</b>	1.46	3.54	5.00	<b>1.61</b>

##### ELEMENT #2 - 1.3

SPLIT POSITION – followed by a walkout front or walkout back. The final DD is based on the lowest of the two values.





			<b>Total</b>
<b>NVT=</b>	23.0	8.0	
<b>PV=</b>	7.42	2.58	
			<b>31</b>
			<b>1.42</b>

			<b>Total</b>
<b>NVT=</b>	19.0	6.0	
<b>PV=</b>	7.60	2.40	
			<b>25</b>
			<b>1.31</b>







**ELEMENT #3 – 1.1**

SPINNING 180° – From a Bent Knee Position, a Spin 180° is executed as the legs are joined to a Vertical Position at the ankles followed by submergence.

			<b>Total</b>
<b>NVT=</b>	15.0	0.0	
<b>PV=</b>	10.0	0.0	
			<b>15</b>
			<b>1.13</b>

**ELEMENT #4 – 1.3**



TRAVELLING BALLET LEG COMBINATION – Beginning in a Back-Layout Position a ballet leg alternate is executed with travel. The DD is based on the lowest value of two positions combined.

						<b>Total</b>
<b>NVT=</b>	10.5	11.0	(13.0 or 18.5)	3.0	19.0	
<b>PV=</b>	4.77	5.0		1.36	8.64	
						<b>21.5</b>
						<b>1.25</b>

**ELEMENT #5 – 1.6**

BARRACUDA BENT KNEE – From the Back-Pike Position with the legs perpendicular and the toes just below the surface, a Thrust is executed as one leg is drawn along the inside of the other extended leg to assume a Bent Knee Vertical Position. A Vertical Descent is executed in a Bent Knee Vertical Position at the same tempo as the Thrust.



			<b>Total</b>
<b>NVT=</b>	28.0	11.0	<b>39</b>
<b>PV =</b>	7.18	2.82	<b>1.57</b>

### 8.1.6 Safety Marshalls for All Sports

The safety Marshal is a trained position designated by the OC.

Safety Marshals shall:

- Be visible by safety vest
- Be situated at each end of the competition pool,
- Actively monitor all scheduled warm pools and training
- Ensure competitors comply with warm-up safety procedures and report violations to the referee.

A minimum of 2 safety marshals are required for each end of every warm-up pool used during the competition.

### 8.1.7 Violations

Participants witnessed by a safety marshal diving or dangerously entering that water may be removed, by the referee, without warning from their first individual event following the warm-up period in which the violation occurred. They may also receive a verbal warning from the Safety Marshal. Participants receiving verbal warnings will have their names registered with the Event Management and World Aquatics and should subsequent violations occur the participant may be removed by the referee without warning from their first individual event.

In the case of a second offense during the same competition, the participant may be removed from the remainder of the competition by Event Management and/or World Aquatics.

### 8.1.8 Unsportsmanlike behaviour

Any participant found engaging in unsportsmanlike conduct, including but not limited to deliberate interference with another participant, verbal abuse towards officials, competitors, staff or volunteers, intentional obstruction, or any behavior deemed detrimental to the spirit of fair play, will face immediate disqualification from the event and potential disciplinary action by World Aquatics.

### 8.1.9 Return to competition after injury

Based on the recommendation of the LOC Medical Team/Local medical authorities, World Aquatics, as per Constitution Rule IV:17.1, may remove a participant from an Aquatics competition and/or take any other appropriate measure if such participation poses a risk for the health and safety of such participant.

### 8.1.10 World Aquatics Accepted Swimsuits

#### Accepted Swimsuits for World Aquatic Masters Championships

For cultural, medical, modesty or religious reasons, World Aquatics Masters Championships participants ("Athletes") may compete in a swimsuit that covers more of the body than would otherwise be permitted under Article 15.2 of Part Two of the World Aquatics Competition Regulations ("CR"). Such a swimsuit is identified or referred to herein as a "World Aquatics Accepted Swimsuit".

This rule regarding World Aquatics Accepted Swimsuits only applies to World Aquatics Masters Championships.

Capitalized terms not defined herein shall have the meanings ascribed to such terms in the current CR.

**World Aquatics Accepted Swimsuits:**

(i) shall be made of traditional permeable textile (i.e. open mesh) Material (such as cotton, nylon, Lycra and the like), with no application of surface treatment closing the open mesh structure, in accordance with the current CR. The Material shall be flexible and soft folding;

(ii) shall not provide any technical advantage or any performance enhancement in terms of speed, buoyancy, or compression, and such swimsuits may be subject to inspection by World Aquatics in respect thereof, before and after competition;

(iii) shall be modest, in good taste and shall not be transparent;

(iv) may cover additional body surfaces including the legs, arms and/or head, but shall not cover the face, as this is a safety and drowning risk; and

(v) may not raise any safety issues or risks, including, but not limited to, swimwear that prohibits the body from moving freely and/or swimwear that impedes buoyancy.

Athletes are not required to justify their choice of swimsuit; however, Athletes are required, upon request by World Aquatics, to provide additional information pertaining to matters within this rule to assist with World Aquatics' decisions.

Athletes shall have the opportunity to present their proposed swimsuits to the applicable World Aquatics Technical Officials at an organized meeting (the "Swimsuit Consultation") prior to the competition. If an Athlete fails to attend the Swimsuit Consultation, he or she bears the risk of his or her proposed swimsuit being rejected at any time. The decision to accept or not accept a swimsuit, as determined at the Swimsuit Consultation or at any time, shall be at the sole discretion of the World Aquatics Technical Officials.

Athletes shall wear only one swimsuit in one or two pieces. However, a specific opportunity to combine distinct upper and lower apparel components may be allowed (see the list of accepted /unacceptable swimsuits). World Aquatics Technical Officials may use their discretion to grant medical exemptions, enabling an Athlete to wear a swimsuit with an additional piece.

**World Aquatics Accepted Swimsuits:**

1. Full coverage with legging (with or without hood)
2.  $\frac{3}{4}$  length
3. Rash shirt or well-fitted t-shirt
4. Swim skirt
5. Swim shorts
6. Trunks
7. Briefs
8. Swimwear with zippers/fasteners

Lower apparel component #4, #5, #6, and #7 can be combined with upper apparel component #3.

Unacceptable swimsuits:

- Loose fitting t-shirts
- Full body suit
- Full leg suit
- Open Water swimsuit (approved or not)
- Jammers (that are not on the List of Approved Swimwear)
- Full-knee (that are not on the List of Approved Swimwear)
- Loose fitting shorts
- Street wear
- Sportswear



#### Notes

Modifications: World Aquatics Accepted Swimsuits shall not be modified by the Athlete.

Other swimwear: This rule only applies to swimsuits. Other swimwear including wetsuits, goggles and/or swim caps must be approved World Aquatics. in compliance with the Article 7 of Part One of the CR.

#### **Definitions**

**World Aquatics Approved Swimsuit:** A swimsuit that is approved by World Aquatics in accordance with the rules set forth in the Part One, Article 7 CR and valid on the date of approval. An Approved Swimsuit can be used at World Aquatics Competitions, World Aquatics Sanctioned Competitions, qualifying events for World Aquatics Competitions or Olympic Games and shall meet the requirements provided in Article 7 CR.

**World Aquatics Accepted Swimsuit:** A swimsuit that need not comply with the Article 7 CR and that may be authorised for use only in World Aquatics Masters Championships under the circumstances described above.



WORLD  
AQUATICS

[www.worldaquatics.com](http://www.worldaquatics.com)